

A Guide to Starting a Commercial GOAT DAIRY



CAROL DELANEY

**Guide to Starting a
Commercial
GOAT DAIRY**



Copyright © 2012 Carol Delaney
All rights reserved
Published by the UVM Center for Sustainable Agriculture,
a program of UVM Extension

Issued in furtherance of Cooperative Extension work, Acts of May 8 and June 30, 1914, in cooperation with the United States Department of Agriculture. University of Vermont Extension, Burlington, Vermont. University of Vermont Extension, and U.S. Department of Agriculture, cooperating, offer education and employment to everyone without regard to race, color, national origin, gender, religion, age, disability, political beliefs, sexual orientation, and marital or familial status. UVM Extension helps individuals and communities put research-based knowledge to work.

TO OBTAIN A COPY OF THIS BOOK
contact the UVM Center for Sustainable Agriculture:

SUSTAINABLE.AGRICULTURE@UVM.EDU
802-656-5459
WWW.UVM.EDU / SUSTAINABLEAGRICULTURE

*This guide is dedicated to the life of
Jamie Cherington
(1945–2009) of Maple Corners, Vermont.*

*Her tireless work and unwavering support of the
small ruminant industry in Vermont propelled it as
a viable livestock option for commercial farming.*

*She was a person who could build teams and create
harmony out of chaos and discord.*

*This guide is a direct result of her support and that
of an anonymous donor who gave legs to the
Small Ruminant Dairy Project for 10 years.*

ABOUT EDITOR/LEADING AUTHOR

Carol Delaney, M.S., former Small Ruminant Dairy Specialist at the University of Vermont, worked for 10 years as faculty and Extension specialist in the Department of Animal Science and the Center for Sustainable Agriculture (1998–2008). She studied ruminant nutrition at Cornell University for her graduate degree and taught at Sterling College, Craftsbury, Vermont (1989–2003) as faculty and farm manager. She has many years of experience owning and operating farm and food businesses, working on livestock farms, and raising dairy, meat and draft goats. She is currently the Farmer Grant specialist for Northeast Sustainable Agriculture Research and Education (SARE), a NIFA/USDA farmer research grant program. She is available for speaking engagements and consulting as part of her private business, Horn of Plenty Farm. Please send all inquiries and corrections to her at cdhornofplenty@gmail.com.

CONTRIBUTING AUTHORS

Chet Parsons (retired), Livestock Specialist, University of Vermont Extension, St. Albans, Vermont.

John C. Porter, Dairy Extension Specialist, Emeritus, University of New Hampshire Cooperative Extension, Boscawen, New Hampshire.

Mildred Nault (deceased), General Manager, Vermont Dairy Herd Improvement Association, White River Junction, Vermont.

Dan L. Scruton, Dairy and Energy Chief, Dairy Division, Vermont Agency of Agriculture, Food and Markets, Montpelier, Vermont.

Jordan Le Roux, Former Outreach specialist, Vermont Butter and Cheese Creamery, Websterville, Vermont. Currently with GfK Kynetec, London, England, UK.

Glenn Rogers (retired), Farm Business Management Specialist, University of Vermont Extension, St. Albans, Vermont.

Peter Dixon, consultant, Dairy Food Consulting, Putney, Vermont.

Gregory Bernhardt, Co-owner and operator, Blue Ledge Farm, Leicester, Vermont.

Kevin Kouri, Animal Nutritionist, Poulin Grain Company, Newport, Vermont.

Kristan Doolan, Co-owner and operator, Does' Leap Farm, Bakersfield, Vermont.

ACKNOWLEDGEMENTS

I would like to thank the Director at the UVM Center for Sustainable Agriculture, Dr. Linda Berlin, for continuing the support for this project to see it to its finish. Also, for staff at this same Center for their time and editing. Vermont Butter and Cheese Creamery lent time and money in the form of Jordan Le Roux and have supported this document from the start. Dan Scruton from the Vermont Agency of Agriculture, Food and Markets has been a torch bearer for the small ruminant industry nationwide and shared his knowledge generously here. And, lastly, the untethered support from USDA Risk Management personnel at UVM, Bob Parsons and Pam Smith.

Illustration of Alpine goat in woods provided by Rachel Schattman, Local Food Coordinator, UVM Center for Sustainable Agriculture.



Vermont Sheep and Goat Association

Contents

	Foreword	vii
SECTION 1	GETTING STARTED	1
CHAPTER 1	Planning with Knowledge	3
CHAPTER 2	To Sell or Process: That is the Question	6
CHAPTER 3	Time, Production and Financial Management.....	12
CHAPTER 4	Building a Farm Budget: The Customized Budget for Start-up and Enterprise Analysis.....	23
CHAPTER 5	Using VTDHIA Herd Management Records	34
SECTION 2	GETTING YOUR GOATS	37
CHAPTER 6	The Feed Costs of Raising Your Own Dairy Goat Replacements.....	39
CHAPTER 7	Evaluating Dairy Goats.....	43
CHAPTER 8	Resources for Buying, Selling and Marketing Goats and Meat in the Northeast Region.....	48
SECTION 3	FACILITIES	53
CHAPTER 9	Housing and Milking Facilities.....	55
CHAPTER 10	Starting a New Milk Processing Facility: Considerations and Costs	60

SECTION 4	MILK	69
CHAPTER 11	Tests for Milk Quality	71
CHAPTER 12	Guide to Crisis Management of Somatic Cell Counts in Goats	74
SECTION 5	BREEDING	81
CHAPTER 13	Out-of-Season Breeding	83
CHAPTER 14	The Impact of Genetic Selection.....	87
SECTION 6	FEEDING	91
CHAPTER 15	General Goat Feeding Behavior and Diet Recommendations	93
CHAPTER 16	Grazing and Browsing Basics.....	101
CHAPTER 17	Hay: Buy It or Bale It	109
APPENDIXES	111	
APPENDIX 1	Resources.....	113
	• Recommended Books and Articles	113
	• Periodicals and Informational Websites	114
	• Academic and Outreach/Extension Educational Programs	115
	• UVM and UVM Extension Special Agricultural Programs and Services	118
	• State of Vermont/USDA Agencies and Programs	118
	• Vermont Business Planning, Training, and Lending Programs	119
	• Vermont Agricultural Organizations and Member Associations	120
	• Goat Milk Markets/Marketing in Vermont	122
	• Regional Livestock and Fiber Marketing	122
	• Apprenticeship/Internship Programs	123
	• Cheese Products Consultants	123
	• Cheesemaking Classes	123
	• Equipment and Services, Regional and National and International	124
	• National and International Associations and Groups	125
APPENDIX 2	2005 Dairy Goat Budget	128
APPENDIX 3	Risk Management and Crop Insurance	138
APPENDIX 4	Barn Designs for 40, 60 and 288 Goats.....	140
APPENDIX 5	Dairy Goat Milking Facilities	154

Foreword

This guide is meant to provide basic information to those interested in looking at starting a dairy goat farm as a business. Other books cover the detailed management of dairy goats while this guide seeks to touch on those topics that strongly influence management choices. One exception might be milking systems and equipment but we leave readers in the good hands of the Dairy Practices Council for specific guides published on these topics and referenced in the chapters.

We hope this guide will help the reader make a realistic plan for the investment of finances in land, buildings and livestock — and decide for or against that investment. We have faith that those who are serious will take the time to write a mission statement, set goals, and create record keeping systems to measure their progress. Then, they will be empowered to use all this data to inform their future decisions. With whole farm, family and land goals to refer to, managers can adjust their operation to correct problems and make informed changes to fulfill their goal.

This author believes that long term success in farming is rewarded to farm stewards who:

1. write down their goals, create a business, land and family plan with a mission statement by defining

who is involved in the farm, what resources there are, how they will measure success and what they want the future landscape to look like;

2. manage the operation in a manner that improves the quality of the land, air and water;
3. show a profit that matches their ideas of what is needed to sustain themselves;
4. intentionally create a good quality of life for themselves, their workers and the surrounding community; and
5. continue to evolve in their knowledge of farming, are able to share in an agri-culture with other farmers and the community, and only operate the farm if they continue to love and enjoy the work.

Now, a word about sustainability from a global perspective presented at the 2008 International Goat Conference in Querétaro, México. Dr. Christie Peacock, CE at the international office of the development organization, FARM AFRICA, in her keynote talk gave her description of a sustainability scorecard for goat production around the world. First, she described goats, and maybe goat farmers, as “independent, inquisitive, adventurous, intelligent, easily bored, hard to contain, tough, resilient, non-

conventional and traditional.” Second, she rejected that sustainability meant “persistence, stability or maintenance of the status quo.” Instead, she noted that “resilience and the ability to adapt will support continuation.”

Lastly, she lists 4 essential qualities of the farm and the surrounding environment that support the most sustainable goat production system. Take note that most of the qualities are external to the farm.

They are:

1. Environmental: The forage, water and concentrate inputs are grown by the farmer or someone locally;
2. Economic: There are strong markets for live animals and process products.
3. Social: There are well-enrolled farmer-member organizations that goat farms join for advocacy and mentoring; there is a public awareness and appreciation of goat farms demonstrated by annual cultural activities and education programs for new farmers;
4. Institutional infrastructure: There is a breadth of advanced skills in the support services that provide appropriate information, research and continued education.

SECTION 1

**GETTING
STARTED**



Planning with Knowledge

Carol Delaney

Farming your land with dairy goats is a viable choice in Vermont, New Hampshire, and other states in the Northeast. There is a growing and unfilled market for fluid milk, farmstead cheeses, and farm tourism in these states. Dairy goats can be a good fit once you have analyzed your available human, land, financial, and support resources. Evaluating the fit to your land and family, as well as the financial returns, is an important and unavoidable step to help ensure your success. In this guide, we aim to give you the tools to analyze whether a dairy goat business is a viable option for you.

Start Slow and Dip Your Toe in the Sea of Goats

If you understand that working with dairy goats is a daily commitment, the next step is to find out if you enjoy working and being with dairy goats. They are likable, inquisitive animals more akin to dogs than to cows in personality. To experience goats, visit existing dairies, talk to farmers, and contact associations listed in the Resources section in the back of this guide. Obtain a couple of goats and go through a kidding to observe their particular needs, even if you already have livestock experience. Subscribe to dairy goat periodicals and buy a few books on raising goats. You can also find these items in the Resources section.

Verify Your Management and Decision-Making Team

Discuss with your family members or partners how much they will participate and find out what they expect in return. While a spouse or partner may be working off the farm, they will have a vested interest in the profits and labor requirements; therefore, they are a part of the management team. If other children or family and friends are hoping to be part of this, they need to be involved in making decisions from the beginning. Ask everyone to write the answer to the questions “What are we managing towards?” and “What is the vision or picture you have of your ideal goat farm?” Books written about the qualities of leaders and efficient managers say that an important component of exceptional management is to have an image of the goal. Share the results and develop one summary paragraph on which all can agree.

For examples and a method to follow, here are two resources. One is Allan Savory’s *Holistic Management Handbook: Healthy Land, Healthy Profits* (Island Press, 2006).

Second is a recent local book, *The Organic Farmer’s Business Handbook: A Complete Guide to Managing Finances, Crops, and Staff — and Making a Profit* is also recommended. It is easy to read, talking in the

first person by author, Richard Wiswall, who shares his journey on how he applied holistic management to his farm and guides the reader on exactly how to do the same.

Find Help with Business Planning

An excellent resource for directions, examples and worksheets for working on your farm business plan is *Building a Sustainable Business: A Guide to Developing a Business Plan for Farms and Rural Businesses*. It is available for free as a download from WWW.SARE.ORG/LEARNING-CENTER/BOOKS. In Vermont, refer to the Resource Guide for Vermont's New and Aspiring Farmers, found online at www.vermontagriculture.com/agdev/newfarm.htm.

Consider Feed from Land as a Renewable Resource

Look to your land and the feed base around you. Goats will graze but do best with available woody shrubs, saplings, broadleaf plants and weeds as part of a rotation. Look at the labor and capital costs of buying feed versus harvesting your own feed. (See Chapter 17 Hay: Buy It or Bale It.) Cost will depend on prices and resources in your area. A year-round confinement herd is possible, but any time livestock are outside harvesting their own feed, money is saved and the animals are in a healthy environment. The importance of this comes from another angle: goats have a high metabolism rate, and much of their daily feed goes toward keeping them alive. Based on pounds of feed per pound of body weight, goats eat more than cows just to stay alive, besides what they need to eat to produce milk. Milking dairy goats eat over 5% of their body weight in dry feed per day; a cow needs to eat only about 3.5%. With goats, it is crucial to find economical feed and it makes sense to manage the soil for the optimum production of good-quality feed.

Determine How Big Is Big Enough

Fewer than 150 goats is usually not enough to support one person or a small family with fluid milk sales, based on most people's standard of living.

Other farm or off-farm income would be necessary. Milking 150–200 goats is the minimum needed to start providing a sustainable income. Above that, more labor is needed than the usual one or two members of the family or partners involved can provide.

Farmers in Vermont who milk 30–85 goats for making farmstead cheese will even buy milk instead of adding goats, to give them more time to make and market cheese. Milking more than 30 goats and making cheese would require a second person to help with some aspects of the business.

Your investment could be as little as \$15,000 and as much as \$100,000 for any of these operations. This guide contains scenarios and budgets you can use to assess your own situation.

Assess Your Location

Your location could turn out to be an important aspect of the success of your farm. In cheese making, the most money is made in direct sales, so proximity to a farmers' market or a direct cheese outlet is an asset. If you are near a consumer population, consider farm tourism as part of your income if that fits your personality. Selling fluid milk to a local cheese maker could allow you to have a smaller herd size. If your goal is to support a family by selling fluid milk, there is an advantage in the decreased trucking cost realized when you are located close to a milk purchaser, e.g., Vermont Butter and Cheese Creamery in Websterville, Vermont).



Photo 1.1 "Ready, set, go!"

Create a List of Your Resources and Support Professionals

Even though goats are smaller and need less space than cows, a significant investment in housing, parlor, milk house, initial breeding stock, and, in some cases, cheese room is required. For most people, one year of lead time is necessary before milk can be produced for sale from the farm.

Create a list of local support professionals who can help with your planning process and management after you start your enterprise as in Table 1.1.

This includes veterinary practitioners, Cooperative Extension agents, Agency of Agriculture regulators, USDA Farm Service Agency and Natural Resources Conservation Service (NRCS) personnel, and university professionals. Join goat associations to have access to directories of breeding stock and a supportive group to help you get started. Look to experienced farmers for advice. Build a library of reference books and magazines. You can find a list of many of the above in Appendix 1.

Ready, set, go!

Table 1.1
Create a contact list for planning, information and support

Building/ventilation consultant _____
Extension agent(s) _____
Farmer mentor _____
Farming/marketing association _____
Feed company representative _____
Financial/business planning advisor _____
Goat association(s) _____
Grazing/livestock association _____
Land management/soil advisor _____
Lending institution agent _____
Local hay/forage producer(s) _____
Market for milk _____
Market for cheese _____
Market for culls _____
Market for kids _____
Milk equipment technician and sales _____
Nutrition consultant _____
State agency milk regulators _____
State agency milk processing regulators _____
USDA Farm Service Agency _____
Veterinarian _____



To Sell or Process: That is the Question

Carol Delaney

The main options for selling goat milk are as a fluid, raw product and as processed, pasteurized, fermented or cultured cheese and milk products. The decision of what income path to take will determine the size of your dairy. For regulations on selling raw milk or other products, go to the Vermont Agency of Agriculture's website: WWW.VERMONTAGRICULTURE.COM/FSCP/DAIRY/REGULATIONS.HTML or the one from your respective state. If you are selling across state lines, the state where you process will have to have reciprocity with the standards of where the product is shipped. For anyone dealing with sales of milk or milk products, a copy of the US FDA's Pasteurized Milk Ordinance (PMO) is essential. It is available online at WWW.FDA.GOV/FOOD/FOODSAFETY/PRODUCT-SPECIFICINFORMATION/MILKSAFETY/DEFAULT.HTM

Fluid Milk Sales

Most simply, anyone who milks an animal in Vermont may sell up to 50 quarts per day of raw milk to customers who buy the milk on the farm. Neighboring states have other laws that determine what tests or processing equipment are needed. New York State requires monthly milk testing for pathogens and other indicators of quality. Regardless of the

location, it is advisable to set up a milk quality and pathogen testing schedule to make sure the milk is safe for sale.

The next category of fluid milk sales is milk sold in concert with other milk producers for processing at a large cheese plant. There should always be a written contract in place with the details of the purchase and sales agreement. Regardless of any written contract, in Vermont there is a regulation that required that the milk purchaser must notify the producer 30 days before they stop purchasing milk. A commitment by the farmer to create or match goals of milk quality desired by the cheesemaker will only strengthen the ties between them and ensure the desirability of the milk to other purchasers.

The next category of fluid milk sales is milk sold directly to a small cheese producer. For a farmer who wants to remain seasonal and milk under 100 goats, one possibility becoming more common, is to sell fluid milk to a neighboring cheesemaker. The transportation will be handled by either the milk producer or the cheesemaker. Experienced goat farmstead cheesemakers with an unmet demand for their own goat cheese may find that they don't have the space, time, resources or inclination to increase their herds. Here is where reference to your own farm's goals is important to help you make the decision

Figure 2.1
Options for selling goat milk

Fluid Milk Sales
To on-farm customers, raw milk sold in Vermont is limited to 50 quarts per day
To local cheese maker, seasonal milk from herds under 100 milkers
To large cheese plant, fluid milk sold year-round with 200+ milkers
Processed Milk
Pasteurized milk in bottles
Yogurt, cultured products and ice cream
Cheese Sales
Farmstead cheese distributed locally or regionally
Green cheese sold to affinage business
Other Businesses
Soap and lotions
Pet or exotic animal food

whether to supply them with fluid milk. It is useful to find out what is driving the cheese maker to buy milk and what situation would fit their needs best. Based on that, a contract can be worked out.

In Vermont the most common example for those farmers who want to earn a living selling fluid milk is to start milking at least 100–200 dairy goats year round with a goal of milking 400 or more. This is based on the requirements of the one large purchaser of fluid milk that picks up milk in Vermont and the neighboring states: Vermont Butter and Cheese Creamery (VBCC).

One main reason for the large animal numbers needed is that, compared to the plentiful number of cow dairies, there are only a few goat dairies spread out over a large distance from BCC's cheese plant and thus, the trucking costs are much higher. Currently the farmers share the trucking expense with VBCC. The two biggest factors in trucking cost per unit of milk shipped are size of the herd and seasonality of the milk production. For two extreme examples, in 2006, a small goat dairy milking 40 goats seasonally (May through February), paid about

\$15 per hundredweight to ship milk and another goat dairy milking 200+ goats year-round paid, on average, less than \$3 per hundredweight for trucking although, the small goat dairy was closer to the cheese plant.

It's more efficient to pick up larger quantities of milk in fewer stops. When the herd is seasonal, there are times when the milk in the bulk tank on pick-up day is very low. There is a stop charge each time milk is picked up so, if there is not a lot of milk in the tank either because the herd is small or it is when the whole herd is at the end of lactation, that base fee will have more of an impact on the total per pound cost of trucking.

If shipping fluid milk year round is the preference, a land base and facilities will be needed to house all the milking goats plus 25% more head of replacement doelings, plus 1 buck per 30–50 breeding does, and a nursery to start twice the number of kids as bred does. Also, two housing facilities are recommended with one to provide light control for out-of-season breeding. Besides animal housing, facilities are needed to store forage, concentrate and bedding. It is best to plan to have enough space to be able to store all the forage for one year as a risk management tactic for years with hay of poor quality and scarcity. With all the forage on the farm, it is much easier to balance rations with known forage, even though it is not uniform.

Since VBCC needs fluid milk for cheese year round, it has set up an incentive program to reward farmers for producing milk in the winter months. There is a quota period in the fall/winter when the amount of milk protein purchased sets the base price for the rest of the year. The amount of milk protein sold in this period is valued at a certain premium price. After that period, a farmer selling the same pounds of milk protein also enjoys that same high price. Once the amount of protein sold exceeds the amount that was sold during the quota period, the price falls to a lower, non-quota protein price.

See Figure 2.2 for a 2008 milk purchase pricing schedule and explanation from VBCC. Please note that this is subject to change and one should contact the company directly for the current pricing.

Processed Milk Products

The production of pasteurized milk products includes drinks such as bottled milk, cultured milk, and kiefer, and cultured foods like sour cream and yogurt. Products that use all of the milk are advantageous in that you are not removing water (that you could sell) from the milk and the time from production to sales is very quick. Usually, the main obstacles to selling these products are developing a market and the initial higher cost of investment in equipment such as a pasteurizer, bottling and capping machine and, possibly, a separator. Creating products such as a line of milk drinks with differing fat content (eg. whole, 2%, 1%, skim) will create cream as a by-product that will need to be used with another product like ice cream or half-and-half. Ice cream requires a base mix, the addition of a recipe of flavoring and a way to pasteurize the mix and then freeze it. At this writing, there are no frozen goat milk products produced in Vermont.

Cheese Production

To produce cheese designated “farmstead,” all of the product must come from milk produced on the farm where the cheese is made. Most cheesemakers start with the goal of producing cheese only from their animals. The highest profit is usually obtained by selling the cheeses directly even though it requires more labor and customer interaction. The least income comes from selling at a wholesale price to a distributor where customer contact is limited and the price and labor requirement are lowest. Depending on the sales categories chosen — direct sales (e.g. on-farm, farmers’ markets); direct wholesale accounts (e.g., local restaurants or CSAs, or wholesale purchased by a distributor, farmstead cheesemakers in Vermont have found that they need to sell between 22,000 and 55,000 pounds of cheese a year to make a living. A general rule of thumb for production levels and markets:

- 15,000–40,000 pounds of cheese allows for hands-on marketing with owners being the sales force, including the use of some distributors as well as direct sales to customers

- 70,000–100,000 pounds of cheese requires main dependence on a wholesale market

Sample business evolution of two farmstead goat dairies in Vermont are presented here:

Blue Ledge Farm, Salisbury, Vermont 2007

WWW.BLUELEDGEFARM.COM/



Blue Ledge Farm is run by a young couple, Gregory Bernhardt and his wife, Hannah Sessions, who have two very young children. They started milking goats in 2000 and began their cheese operation in 2002. They have had interns who lived on the farm to help with the grazing goat herd, milking, cheesemaking and farmers’ markets. They buy goat milk from another farmer nearby. Hannah and Greg have been in business about 8 years. They bought a former cow dairy and rely on this income for their livelihood and to pay back their investments. They make fresh chevre, semi-aged crottina, and La Luna farmstead gouda. As a former American Cheese Society winner, Gregory presented at the 2007 American Cheese Society annual conference in Burlington, Vermont in a talk called “How Big is Big Enough?” He indicated that they:

- started with no apprenticeship history;
- purchased an old dairy farm in 2000 when real estate was cheap; they sold development rights to be able to invest in farm;
- both husband and wife now work on the farm after 2–3 years of husbandworking full-time off the farm with teaching job; have 2 small children;
- utilized interns, part-time labor and expect they will pay for 2 part-time laborers;
- only purchase new equipment as they can afford it;
- have a 50–70 mixed herd goat dairy; the goats are a seasonal herd, pasture based;
- started with 50% of cheese sold at farmers’ market;
- started purchasing more goat milk from nearby farm with 40 goats in 2006;

VBCC Milk Purchase Pricing Schedule

In June 2008, this is how VBCC explained its payment system:

As of May 2008, we are now paying \$11.50/# of quota protein/ \$9.50 for nonquota protein and that will jump to \$12.50/# of quota protein and \$10.50/# of nonquota protein. Quota is “built” during the fall period when our company needs the protein as over ½ of our sales are September to January. VBCC tries to get farmers to maximize production during this period. Quota is determined this way:

1. Protein production for the pickups October 1 to January 31/17 (weeks) = quota 1
2. Protein production for the pickups November 1 to February 28/17 (weeks) = quota 2
3. Protein production for the pickups November 1 to March 31/22 (weeks) = quota 3

Whichever is the highest weekly quota is the quota for the months April 1 through September 30th. Any protein produced over that quota is paid the nonquota price for those months. A new quota is built every year. Quality premiums are paid on all milk during all periods.

When a new farmer starts, they have no “history” and an agreement is made for a quota for the start up period. Also, if a farmer makes a substantial increase in milk production, VBCC will grant additional quota.

Quality levels are:

	Raw	Past	SCC
Level 1	10,000	100	700,000
Level 2	20,000	200	800,000
Level 3	50,000	400	900,000
Level 4	100,000	1,000	1,000,000

Payments as of May 1, 2008:

				Bonus	Max
Level 1	\$1.70	\$.60	\$1.40	+ \$1.80	\$5.50
Level 2	.80	.20	.80	+ \$1.20	\$3.00
Level 3	.60	.15	.55	+ \$1.00	\$2.55
Level 4	-.50	-.15	-.45	-\$1.10	—

Since the milk samples are tested twice a month, the quality is the average of the two scores in each category which is paid once a month.

Examples of on-farm payment plans from Vermont Butter and Cheese Co.

Example: a goat herd tests 4.24% protein plus its quality scores are 8,000 raw, 10 past, SCC 500,000

4.24% protein x \$12.50/lb protein = \$53/ cwt. plus the monthly bonus of \$5.50 = \$58.50/cwt. milk
(for the quota milk or all milk during a quota building period)

Example: a goat herd testing 3.4% protein plus its quality scores are 50,000 raw, 400 Past, SCC 1,100,000
3.4% protein x \$12.50/lb protein = \$42.50/cwt. milk plus the monthly bonus of \$.30 (.60 + .15 - .45) = \$42.80/cwt.

Figure 2.2 Vermont Butter and Cheese Creamery 2008 Milk Pricing Schedule.

- sold 18,000 pounds goat cheese in 2006;
- started purchasing cow milk, 700 pounds per week in 2007;
- sold approximately 22,000 pounds of cheese in 2007; priced at \$7.50–\$12/pound;
- have a retail market that is 21.5% of business (Farmers' Market, online/farm sales);
- sell through Vermont stores for 45% of their business;
- only use a distributor for 10% of their sales;
- pay themselves \$36,000 per year after farm expenses; they pay house mortgage with this.

2010 Update:

- produced 30,000–35,000 pounds of cheese;
- farmers' market is 4% of sales though sell 50% of cheese in Vermont;
- labor split: Hannah spends 70% with goats and 30% with cheese; Gregory spends 70% with cheese and 30% with bookkeeping and goats. Feel that the true split of labor at the farm is 60% production and 40% in marketing the cheese.

Does' Leap, Bakersfield, Vermont 2007

WWW.DOESLEAP.COM/INDEX.HTM



Does' Leap is run by George Van Vlaenderan and Kristan Doolan who have two small children and produce organic chevre, a Bulgarian-style feta, a petit chevre rolled in Provence herbs, caprella and a raw milk, semi-soft trappist cheese. Their goats feed on wild vegetation and spend all but the winter months outside. This natural diet is supplemented with organic whole grains. They started small with a bare land purchase of mostly wooded acres, which made it affordable. Starting in 1998 they slowly built a barn and home and cheese facility and now receive all their income from this endeavor. In 2009, they won the Vermont Sustainable Farm of the Year Award. Details of their farm are:

- 40 milking goats, certified organic herd/farm
- seasonal herd; pasture based;
- husband and wife team started in 1998 after college education in sustainable agriculture;
- purchased woodland with no buildings and started from scratch 1998. Borrowed from family and paid back within 5 years;
- goal to have no debt, so few things are purchased with loans;
- lived in yurt and built small, plastic covered greenhouse for goats;
- now have barn with attached house and aging cave in basement;
- heat all water for cheese room and house with outdoor woodburning stove and wood harvested from property;
- labor from intern(s) that live in intern housing on property; some food provided;
- only make dairy products from own goats; variety of products to please market: keifer, chevre, two mold-ripened cheeses, feta, and a hard-washed rind;
- processed 53,000 pounds of milk into about 8,000 pounds of cheese @ \$10/pound or \$80,000 gross income;
- personal use is another 1,000 pounds of milk per year and amount fed to raise replacements is not estimated;
- sell at Farmers' market, CSA in Burlington, Vermont and at natural food stores;
- income \$40,000 net for family and any capital purchases for farm improvements. They built slowly so they have no debt.

Selling "green" (not fully aged) cheese to an affineur (someone with an aging facility and a skill for ripening "green" cheese) is a possibility in Vermont. Jasper Hill Farm in Greensboro, Vermont has built a large cave with different aging rooms for different styles of cheeses purchased from other farmstead cheese makers. As an example, the cave business paid \$11 per pound for a 3-day-old semi-ripened goat cheese in 2008.

Other Businesses

Other nonfood goat milk products that have demonstrated potential for profit and demand are goat milk soaps and lotions, and milk to supplement newborn and/or orphaned valuable animals like purebred horses, dogs and exotics. However, the volume of milk used for these products can usually be provided by 1–10 goats. They are worth mentioning as a family member may want to try to develop a secondary market for milk. Apply your own research for these options.

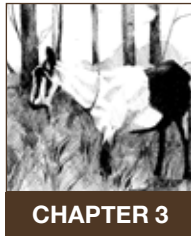

Time, Production, and Financial Management

Carol Delaney

Even if you own only a few animals at the moment, you can start keeping records to help you manage your enterprise, build a budget for investment, and measure the results of your decisions. Here are suggestions for keeping track of labor and feed inputs, and records of production. The biggest costs on your farm will be the labor spent and the feed fed. Breaking down where work and feed inputs are consumed will be the basis for making decisions to attain goals. The reason to break down different parts of the business into enterprises, even if they are not profit centers, is to show what they cost in relation to what they produce. For example, keeping track of the time, feed, bedding, and medicine to raise replacement doelings will elucidate what it costs the business for each replacement. If the cost of raising a doeling is higher than buying a comparable one, a flag is raised that will prompt you to analyze where the money is going. The only way to do this is to have records to examine and share with any consultant who is trying to help you improve your enterprise.

Even with two people working full-time, there are times when part-time labor is desirable to maintain attention to detail, like at kidding times, or to give the farmers time for something else. By keeping records, it is easy to pinpoint the best times to have hired labor come in.

This chapter, then, is a combination of keeping track of inputs and outputs that will be invaluable for guiding the enterprise in the desired direction.

Managing Time

First, did you list your goals; write down who is involved in the operation and what you want the future to look like? The reason to mention this in the time management section is that many people write down that they want to have a reasonable work day time-wise and at least 2 weeks of vacation per year. If this sounds like what you want, keep reading.

It is hard to say how many hours a week is needed per number of goats as that is highly dependent upon how efficiently every aspect is planned, set up, and managed. If this is a full-time business that has a small herd of 30–70 animals with cheese making or a 200–300-head herd two people will be involved.

Put in your brain that the farmer is the manager and is running the operation and not letting the operation run her or him. One way to keep the steering wheel in the proper hands is to institute two simple acts on the farm: a weekly planning meeting and a time to think and look at records without interruptions. Each could take 30–60 minutes and

Table 3.1¹
Examples of parlors, number of milking units and milking rate to keep milking time at 1.5 hours*

Parlor Style	Number of People Milking	Number of Milking Units	Number of Does Milked per Hour	Herd Size – Number of Milkers
12 head gate platform with 4 milk cans	1	4–6	50–90	Up to 100
Straight-through, double-6	1	6–12	80–130	Up to 250
Straight-through, double-12	1	8–16	150–180	Up to 250
Herringbone-12	1	6–12	100–140	Up to 500
Herringbone-16	1	8–16	130–220	Up to 500

*See information about milking parlors in Appendix 5.

will be the most valuable use of time spent during the week.

Labor Distribution

The three big tasks that consume labor hours are milking, feeding and cleaning.

The biggest daily time commitment, no matter what size herd, is milking the goats and cleaning up the parlor and milk room. Ideally, you would like to milk no more than 1.5–2 hours per milking twice a day. Table 3.1 gives guidelines to the type of parlor and equipment needed to keep milking time at a minimum. (See the article in Appendix 5 to learn about parlor types as well as ordering specific guides from the Dairy Practices Council, Appendix 1). There are other types of parlors, like rapid-exit, so talk with other farmers and find out the time it takes to milk and clean and make plans for your future sized herd to help you control how much time you spend milking and cleaning.

Table 3.2 shows recommended platform heights in relation to the height of the person milking for the best ergonomic set up. This will help keep the person who milks comfortable and more content.

After-milking, feeding and cleaning figure next in the amounts of labor required. For many farm operations, time and money spent on labor is crucial to not only profitability but quality of life for the farmers. It would be good to record how time is spent on the farm for each area of work (see Table 3.3, page 14). You might set up one log area of the barn or

group of animals and keep the clipboard with the log right there. Or have a single log in a central office area where you go every day. You can then assess if your daily operation is changing in the direction you want, or if you need to hire someone to do the jobs you dislike the most. While this seems like overkill or a big bother, the good news is that once you have a good handle on labor inputs around the farm, daily record keeping can fade away and only be reinstated if a new system is implemented.

The data from the labor log can be tallied and used to produce a labor sheet for the major tasks involved in raising kids on the farm. This data will then contribute to the discussion of the cost of raising replacements, how time is spent on the farm and when hired help is needed as seen in Table 3.3. Labor sheets can be kept for each category of goat, like milkers, dry goats, bucks and meat animals. Table 3.4 is an example of a labor sheet for how work is divided in raising replacements.

Table 3.2¹
Recommended goat platform height with human height in the parlor

Farm-worker Height	Goat Platform Height
less than 5 feet 5 inches	3 feet
5 feet 5 inches to 5 feet 9 inches	3 feet 2 inches
5 feet 9 inches to 6 feet 1 inch	3 feet 3 inches
greater than 6 feet 1 inch	3 feet 5 inches

Table 3.3
Daily labor record log for kid and replacement care

Date	Task	Labor Time	Notes
March 15–25	Feeding milk to kid	45 minutes twice a day for 1.5 hours	50 kids, 5 sick
March 16	Ear tagging	15 minutes	10 kids
March 1, 10, 20, 30	Clean out bedding in all pens	2 hours each time	

Table 3.4
Labor sheet — hours or days

Kid Care Data Categories	January-March Time spent hours/days	April-June Time spent hours/days	July-September Time spent hours/days	October-December Time spent hours/days
Notes: totals of animals				
Feeding nursing kids				
Cleaning nursing kid area				
Medical care and other events				
Feeding weaned replacements				
Cleaning weaned replacements				
Recordkeeping				
Other: driving to buy feed, time with vet				
Bringing kids to sale				
Notes: major events, kidding, illness, etc.				

For a timesaving method of feeding to a group of kids, one farmer in Québec built a simple pipe delivery system. Photo series 3.1–3.4 shows a utility sink where the milk or milk replacer can be mixed or held, a flexible tube with a valve connecting the reservoir to a PVC pipe which runs along and is mounted on plywood. On the other side of the plywood, where the kids would be, are nipples mounted on plastic protected plywood and connected to the PVC pipe through holes drilled through the plywood. The volume of the pipe is calculated to match a volume in the sink so that the same amount is delivered to each nipple. The system is filled with milk then the

kids are allowed to run in and drink. This farm actually cleaned the pipe with an automated clean-in-place system after feeding.

Bedded Pack vs. Routine Bedding Removal

A bedded pack is lower in cost and labor but attracts more flies, lice and mites; the build-up in layers over time can interfere with feed mangers and it will take more power (HP) to remove it.

Routine bedding changes keep goats clean, lower the incidence of mites, lice and flies and are easier to clean out than deep bedding but cost more and takes more labor.



Photo 3.1 Utility sink where the milk or milk replacer can be mixed or held.



Photo 3.2 A flexible tube with a valve connects the reservoir to a PVC pipe which runs along and is mounted on plywood.



Photo 3.3 PVC pipe and holes are drilled through the plywood to the feeding area.



Photo 3.4 On the other side of the plywood are the nipples where the kids feed.



Photo 3.5 (ABOVE) Tractor with attachment to clean out bedded pack.

Photo 3.6 (RIGHT) Bobcat with prongs for cleaning a bedded pack.



Managing Production: Inputs and Outputs

Keeping general category financial records is necessary for tax purposes and for lending institutions but if the budget analysis of the different costs centers of the farm (e.g. milking herd, dry does, kidding costs, raising kids, raising kids for meat market, bucks, etc.) are desired, the value of the detailed records becomes obvious. Estimates can be used as the farm operation begins. Again, keeping such detailed records may seem overly laborious, but once the inputs and outputs are known, the task will become easier and, sometimes, less necessary.

For example, if all grain is purchased in bulk but fed both to replacements and the milking herd, keeping track of the amount fed to each subgroup will help reveal the cost of raising replacements (Table 3.5). A specialized sheet listing bags of milk replacer or amount of milk fed per number of kids would be very useful to track feed costs until weaning. Knowing the number of kids fed for how many days would be an essential piece of information used to calculate the cost per kid.

Production and animal records: Improvements through genetic selection and management can be

made only if you know your animals individually and track their performance. This will also be invaluable when you try to set a price when selling any animals. Here are the key elements to record:

Identification system: Ear tags, tattoos in ears, tail or on udder attachment plus neck tags on collars.

Pedigree records: Written records of birth date, siblings, multiple birth number, sire and dam identity.

Growth rate of kids: Track identity using one of the above methods. Then, use a hanging scale or crate scale to weigh kids. Measure weight once a week for first month then every 2–4 weeks until weaning. This will give you great feedback on your kid raising system.

Health: Write what and when for vaccinations, medical treatments, procedures (disbudding, extra teat removal, etc.), body weights and body condition scores, problems, and reasons for culling.

Milk Production: Milk yield is highly heritable and influenced by management, so it is very useful to measure, at least once monthly, the pounds a doe produces. You can do this yourself with your own portable milk meters, electronic milk metering equipment or weigh jars in the parlor. It is best to

Table 3.5
Sample barn sheet for feed allocation

Month: January Date:	2nd-cut Hay: \$3.50/ bale	1st-cut Hay \$3.00/ Bale	Round Bale: \$35	Dairy Pellet: (lbs) 16% CP	Other Grain 18% CP Kid Feed	Salt, Mineral	Number of Animals	Type of Livestock: Newborn–2 months 2–6 months 6 months to First Kidding Dry Goats Milkers Bucks Other Farm Livestock
1			1	300			100	milkers
	3				5		20	newborn to 2 months
	2			5			10	2–6 months
		1					2	bucks
		.5				.5	1	horse
2								
3								

measure individual milk production once a month throughout the year for it to provide really useful information (i.e. to determine a complete lactation, to pinpoint production problems, etc. See Chapter 5). You can choose to measure one or two milkings per month and have a technician do it. If milk yield is measured, it is a good use of time to take a milk sample from each doe and include the analysis for protein, fat and somatic cell count (SCC). Knowing the amount of protein and fat solids in milk (both heritable traits) would aid in animal selection. If the price for milk sold incorporates a premium for low SCC, then knowing this measurement would be very valuable. Individual animals with high SCC can elevate the bulk tank SCC and lower the quality.

Compare the cost and labor-time investment of your own milk measurement system with that of milk herd testing services like the Vermont Dairy Herd Improvement Association or DairyOne (see Chapter 5 and Appendix 1 “Resources”). The advantage of employing an outside milk recording business is that a trained technician does the measurements and the service can include an electronic recordkeeping system for storing herd information, including health, breeding and pedigree (PCDART software, in the case of DHIA). This data can be manipulated many ways to see reports on trends in your herd or to pull up records on individual animals you may want to sell or cull or remove from the milking string for high SCC count. For report examples, see Figures 3.1 and 3.2.

These services will also help keep track of the total number of animals on your farm every month, which is a key element to making calculations of costs, profitability, and efficiency of labor. If you choose not to use a service like DHIA or Dairy One, at least write down on your calendar each day or week or month, how many animals you have. Keeping track of your animal population throughout the year will help you calculate milk production per doe, milk used per kid, feed costs per group and more.

Animals to count daily on the barn calendar or once per month in a record book:

- milking does;
- dry does;
- bucks;

- bucklings for breeding;
- kids for sale/meat;
- replacement doelings:
 - 0 to 2 months (or weaning)
 - 2 to 6 months
 - 6 to 8 months (breeding time)
 - 8 months to kidding

For animal and production records, you can create your own spreadsheets, pay for livestock records software or find some free options. Start by looking at the Maryland Small Ruminant webpage found in the Appendix 1, “Resources.” A list of many software programs with weblinks can be found.

Financial Record Keeping

The records needed for income tax filing are very minimal but are a useful place to start. Figure 3.3 is a copy of the 2010 IRS Form 1040 Schedule F front page. The companion instructions are found in IRS Publication 225 Farmer’s Tax Guide.² When starting a business, it is good to know how to categorize the purchase of breeding goats and the investment into the business.

First, recognize that the purchase of livestock for producing milk is a capital investment like a tractor is. Purchased goats have a depreciation period, usually 5–7 years. If one of those purchased animals dies or is sold, the identified animal has a purchase price or basis that is compared to the value of the animal (depreciated) when the death or sale occurs. That sale or death will be calculated to be a profit or loss; thus, good records of the individual animal purchased and its value are important. Animals born and raised on your farm are not in this category.

Often, starting a business takes many months or years of investment before income can be generated and a Schedule F tax return is filed for the first time. In general, only non-capital purchases can be listed as an expense in that tax year. However, when starting a business, there is an exception: a portion of capital costs in the tax year and previous years maybe be entered as an expense. On page 24 and 25 of Pub 225, the Farmer’s Tax Guide, Under Capital Expenses, the IRS states “For tax years beginning in

STAGE OF LACTATION PROFILE

		Stage of Lactation (Days)								Stage of Lactation (Days)						
		1 thru 40	41 thru 100	101 thru 199	200 thru 305	306 +	Total or Avg			1 thru 40	41 thru 100	101 thru 199	200 thru 305	306 +	Avg	
Number Milking	1st Lact	1	31	38	15	27	112	% Fat & Prot.	1st Lact	Fat %	3.7	3.5	3.6	4.3	4.1	3.8
	2nd Lact	1	14	7	13	5	40		Prot%	2.5	2.9	2.9	3.0	3.1	3.0	
	3rd+ Lact	3	19	13	9	6	50		2nd Lact	Fat %	3.6	3.8	4.0	4.0	4.6	4.0
	All Lacts	5	64	58	37	38	202		Prot%	3.1	3.0	3.0	3.0	3.1	3.0	
Avg Daily Milk Production	1st Lact	8	6	6	5	5	6		3rd Lact	Fat %	4.2	3.7	4.2	4.3	3.9	4.0
	2nd Lact	6	6	5	5	5	5		Prot%	3.2	2.8	3.1	3.0	2.9	3.0	
	3rd+ Lact	4	7	5	5	5	6		All Lact	Fat %	4.0	3.6	3.8	4.2	4.1	3.9
	All Lacts	5	6	6	5	5	6		Prot%	3.0	2.9	3.0	3.0	3.1	3.0	

PRODUCTION BY LACTATION SUMMARY

	Number of Cows	Age	Summit Milk	Peak Milk	Projected ME 305 Day			Difference From		
					Milk	Fat	Protein	Milk	Fat	Protein
1st Lact	115	23.0	6	7	1831	70	56	+271	+7	+8
2nd Lact	42	36.0	6	7	1621	67	50	+242	+7	+5
3rd+ Lact	51	66.0	6	7	1681	68	51	+282	+11	+7
All Lacts	208	36.2	6	7	1747	69	53	+266	+8	+7

YEARLY PRODUCTION SUMMARY

Date of Test	Days in Test Period	Number Cows in Herd on Test Day	Test Day Averages		Standardized 150 Day Milk	Test Day Averages (All Cows)				Rolling Yearly Herd average		
			Days in	Milk		%in	Milk	% Fat	% Prot.	Milk	Fat	Prot.
Month Dropped												
8/24/2007	30	123	252	5.3	0.0	97	5.1	4.0	3.0	0	0	0
10/5/2007	42	137	252	5.0	0.0	84	4.2	4.2	3.0	0	0	0
11/13/2007	39	163	215	4.7	0.0	91	4.3	4.8	3.4	0	0	0
12/18/2007	35	159	239	4.9	0.0	88	4.3	4.5	3.2	0	0	0
1/28/2008	41	153	276	5.5	0.0	76	4.2	4.0	3.0	0	0	0
3/14/2008	46	159	252	6.2	0.0	74	4.6	4.3	3.2	0	0	0
5/17/2008	64	211	175	5.9	0.0	95	5.6	4.1	3.0	0	0	0
6/30/2008	44	208	207	5.5	0.0	97	5.3	3.7	2.8	0	0	0
Averages												

Printed 7/9/2008 3:49:10 PM

DRMS
PCDART

Figure 3.1 Herd summary – stage of lactation and production.

STAGE OF LACTATION PROFILE

		Stage of Lactation (Days)					
		1 thru 40	41 thru 100	101 thru 199	200 thru 305	306 +	Total or Avg
Number Milking	1st Lact	1	31	38	15	27	112
	2nd Lact	1	14	7	13	5	40
	3rd+ Lact	3	19	13	9	6	50
	All Lacts	5	64	58	37	38	202
Avg Daily Milk Production	1st Lact	8	6	6	5	5	6
	2nd Lact	6	6	5	5	5	5
	3rd+ Lact	4	7	5	5	5	6
	All Lacts	5	6	6	5	5	6
SCC Score *	1st Lact	4.5	4.4	4.3	4.4	5.1	4.5
	2nd Lact	5.5	4.5	5.8	5.0	5.5	5.0
	3rd+ Lact	5.5	5.0	5.6	6.1	6.1	5.5
	All Lacts	5.3	4.6	4.8	5.0	5.3	4.9
sees >3.9	Number	4	41	41	27	31	144
	Percent	80	64	71	73	82	71

* SCC data in this table are always displayed as linear scores.

CURRENT SOMATIC CELL COUNT SUMMARY

	% Cows by SCC Score				
	0,1,2,3 Below 142,000	4 142,000-283,000	5 284,000-565,000	6 566,000-1,130,000	7,8,9 over 1,130,000
1st Lact	26	23	27	15	9
2nd Lact	12	33	15	25	15
3rd+ Lact	8	22	26	12	32
All Lacts	19	25	24	16	16

YEARLY MASTITIS SUMMARY

Date of Test	% Cows by SCC Score					SCC	
	0,1,2,3 Below 142,000	4 142,000-283,000	5 284,000-565,000	6 566,000-1,130,000	7,8,9 over 1,130,000	Score	Actual
Month Dropped							
8/24/2007	20	20	19	16	25	5.1	863
10/5/2007	18	25	19	16	22	5.0	706
11/13/2007	5	16	20	24	35	5.8	1166
12/18/2007	8	21	20	23	28	5.5	934
1/28/2008	11	21	27	18	23	5.3	779
3/14/2008	27	26	18	15	14	4.6	494
5/17/2008	31	18	17	17	17	4.6	648
6/30/2008	19	25	24	16	16	4.9	654
Averages							

DRMS PCDART

Figure 3.2 Herd summary – stage of lactation and udder health.

**SCHEDULE F
(Form 1040)**

Department of the Treasury
Internal Revenue Service (99)

Profit or Loss From Farming

▶ Attach to Form 1040, Form 1040NR, Form 1041, Form 1065, or Form 1065-B.
▶ See Instructions for Schedule F (Form 1040).

OMB No. 1545-0074

2010

Attachment
Sequence No. **14**

Name of proprietor _____ Social security number (SSN) _____

A Principal product. Describe in one or two words your principal crop or activity for the current tax year. _____

B Enter code from Part IV
▶ | | | | | | | | | |

C Accounting method: (1) Cash (2) Accrual

D Employer ID number (EIN), if any
| | | | | | | | | |

E Did you "materially participate" in the operation of this business during 2010? If "No," see instructions for limit on passive losses. Yes No

Part I Farm Income—Cash Method. Complete Parts I and II (Accrual method. Complete Parts II and III, and Part I, line 11.) Do not include sales of livestock held for draft, breeding, sport, or dairy purposes. Report these sales on Form 4797.

1	Sales of livestock and other items you bought for resale	1			
2	Cost or other basis of livestock and other items reported on line 1	2			
3	Subtract line 2 from line 1				3
4	Sales of livestock, produce, grains, and other products you raised				4
5a	Cooperative distributions (Form(s) 1099-PATR)	5a		5b Taxable amount	5b
6a	Agricultural program payments (see instructions)	6a		6b Taxable amount	6b
7	Commodity Credit Corporation (CCC) loans (see instructions):				
a	CCC loans reported under election			7a	7a
b	CCC loans forfeited	7b		7c Taxable amount	7c
8	Crop insurance proceeds and federal crop disaster payments (see instructions):				
a	Amount received in 2010	8a		8b Taxable amount	8b
c	If election to defer to 2011 is attached, check here <input type="checkbox"/>			8d Amount deferred from 2009	8d
9	Custom hire (machine work) income				9
10	Other income, including federal and state gasoline or fuel tax credit or refund (see instructions)				10
11	Gross income. Add amounts in the right column for lines 3 through 10. If you use the accrual method to figure your income, enter the amount from Part III, line 51				11

Part II Farm Expenses—Cash and Accrual Method. Do not include personal or living expenses such as taxes, insurance, or repairs on your home.

12	Car and truck expenses (see instructions). Also attach Form 4562	12		25	Pension and profit-sharing plans	25	
13	Chemicals	13		26	Rent or lease (see instructions):		
14	Conservation expenses (see instructions)	14		a	Vehicles, machinery, and equipment	26a	
15	Custom hire (machine work)	15		b	Other (land, animals, etc.)	26b	
16	Depreciation and section 179 expense deduction not claimed elsewhere (see instructions)	16		27	Repairs and maintenance	27	
17	Employee benefit programs other than on line 25	17		28	Seeds and plants	28	
18	Feed	18		29	Storage and warehousing	29	
19	Fertilizers and lime	19		30	Supplies	30	
20	Freight and trucking	20		31	Taxes	31	
21	Gasoline, fuel, and oil	21		32	Utilities	32	
22	Insurance (other than health)	22		33	Veterinary, breeding, and medicine	33	
23	Interest:			34	Other expenses (specify):		
a	Mortgage (paid to banks, etc.)	23a		a	-----	34a	
b	Other	23b		b	-----	34b	
24	Labor hired (less employment credits)	24		c	-----	34c	
				d	-----	34d	
				e	-----	34e	
				f	-----	34f	
35	Total expenses. Add lines 12 through 34f. If line 34f is negative, see instructions					35	
36	Net farm profit or (loss). Subtract line 35 from line 11. Partnerships, see instructions. • If a profit, enter the profit on both Form 1040, line 18, and Schedule SE, line 1a; on Form 1040NR, line 19; or on Form 1041, line 6. • If a loss, you must go to line 37.					36	
37	If you have a loss, you must check the box that describes your investment in this activity and whether you received any applicable subsidy (see instructions). • If you checked 37a, enter the loss on both Form 1040, line 18, and Schedule SE, line 1a; on Form 1040NR, line 19; or on Form 1041, line 6. • If you checked 37b, your loss may be limited. See instructions.					37a	<input type="checkbox"/> All investment is at risk and you did not receive a subsidy.
						37b	<input type="checkbox"/> Some investment is not at risk or you received a subsidy.

Figure 3.3 2009 IRS Form 1040 Schedule F – Profit or Loss from Farming.³

2010, you can elect to deduct up to \$10,000 of business start-up costs and \$5,000 of organization costs paid or incurred after October 22, 2004.”

Second, look at the expense and income categories so that you have your expenses organized and ready to fill this out or to hand to a tax accountant. At this point, we should not go further without addressing the financial recordkeeping on your farm. Unless someone will take on this role and do an adequate job, it is best to hire someone. Not only is this for income tax preparation, but for the enterprise analysis that we spoke of before. It is well worth the investment to pay someone to set up your bookkeeping if you are not interested in doing this. Someone on the farm could take over the bookkeeping from the consultant, if that is preferred.

There are many tools available to keep track of spending and income. Here are some common examples:

- checkbook and credit card designated for farm;
- file folders for all receipts by category or vendor;

- New England Farm Account Book – available from Cooperative Extension and online as a pdf from the list of publications found at WWW.UVM.EDU/EXTENSION/AGRICULTURE/?PAGE=MANAGEMENT.HTML
- software for checkbook, cash, and credit card accounts.

An easy to use and inexpensive software program, Microsoft Quicken Deluxe®, is supported by a newsletter, “Quick Tips” from Oklahoma State University in a program called “Quicken for Farm and Ranch Financial Records.” You can visit it online at WWW.AGECON.OKSTATE.EDU/QUICKEN/INDEX.ASP?TYPE=NEWSLETTERS. Note that Quicken® works well until a farm must send out an invoice; the next advanced program from the same company (INTUIT) is QuickBooks®, which can handle invoicing and payrolls.

Whatever the system, be sure to indicate for each transaction what category the expense or income was for. Some receipts might contain different categories like supplies and feed so mark them accord-

Table 3.6
Annual progress indicators (examples only)

	2012	2013	2014	2015	2016
Pounds milk shipped/doe					
Total number of does					
Average days in milk					
Cost of replacements					
Hours/day working					
Hours/day milking					
Income/hour milking					
Paid/cwt (\$)					
Income per doe					
Expense per doe					
Vet expense /doe					
Break even pounds of milk/doe*					

*Break even pounds of milk per doe means the minimum level of production that pays for just the cost of the doe and all the other inputs associated with producing milk.

ingly on the original with matching categories assigned. It would then be best to put each receipt in a folder of the most appropriate category as information back-up even if you keep hand-written or computer records. The IRS requires original receipts.

Annual Progress

When you finish your first year of business and have kept good records, you can then lay the baseline for progress. With your records, calculate indicators (see Table 3.6) that will help you see if you are making progress towards your goals. If time spent per day is important, put that in your Progress Indicators. If milk produced per doe is important, list that along with the income per doe. The only way to calculate some of these indicators is to have monthly or daily records indicating number of animals and other useful numbers.

Exit Plan/Strategy

- Based on progress and desired income, when will you decide that it is time to end the business if it is not performing as desired?

- Based on your lifestyle, when do you want to be working less or changing your career or moving?
- What is the farm transfer plan you are most comfortable with: Pass it down to children as inheritance or sale? Sale to farm manager? General farm sale on the open market? Or is a liquidation preferred?

In any of these situations, all the records kept on the farm will become invaluable to this process.

A useful resource is *A Legal Guide to the Business of Farming in Vermont*. In it is a chapter on Farm Transfer and Estate Planning. Find it at WWW.UVM.EDU/EXTENSION/AGRICULTURE/?PAGE=MANAGEMENT.HTML with more information on farm succession.

ENDNOTES

1. Installations de traite pour les chèvres, 2006, 1^{re} édition, Institut de l'Élevage, Éditions France Agricole, Paris, France.
2. IRS Publication 225 Farmer's Tax Guide. WWW.IRS.GOV/PUB/IRS-PDF/P225.PDF
3. IRS Form 1040 Schedule F. WWW.IRS.GOV/PUB/IRS-PDF/F1040SF.PDF



CHAPTER 4

Building a Farm Budget: The Customized Budget for Start-Up and Enterprise Analysis

Carol Delaney

For more instruction in building a business plan and a farm budget, an excellent resource is [Building a Sustainable Business: A Guide to Developing a Business Plan for Farms and Rural Businesses](#).¹

While you will do most of the work of putting together a business plan and budget, a business planning advisor is invaluable. When planning to start a business, a good first place to start is to calculate the annual family living expenses, as unusual as it may seem to do this. At minimum, the business should be able to support what the family needs to live. Be prepared to have this personal information for grant and lending institutions, too.

The purpose here is to estimate start-up costs and to see if, and when, a dairy goat operation of a certain size is profitable. Thus, the information presented here is first, for a start-up budget and second, for an enterprise budget. For start-ups, the cost of equipment and the number of goats that can be housed are the main questions. For enterprise budgets, the revenues and costs are estimated and the break-even price is calculated. The break-even point is where the total revenue equals the total expense, fixed and variable. This will help point toward the size of herd and the price for the product that is financially viable. For some, the price of the milk is set, so then it is the size of the herd they need to

determine and the cost structure. For others, they know the size of the herd they want but need to know what income this size will give them. On top of this, most businesses take up to 5 years to start providing a reliable profit so another income source is needed during that development period. In reality, many businesses fail in the first 2 years so it is important to keep some savings and outside income available.

After getting a record keeping system going for time or labor, production, and inputs/outputs, the budget that was estimated can be compared with real numbers. If there are not actual records to fill in the amounts, estimates have to be made. In Appendix 2, the article “2005 Dairy Goat Budget” covers a dairy goat enterprise budget looking at 3 different rations applied to herd sizes ranging from 100–400 goats. Throughout the article are explanations of how the figures were developed. The author of that article, Jordan Le Roux, used real and rationally derived expenses and revenues for all the categories associated with operating a dairy goat farm. The assumptions were explained and it is crucial to keep notes of what suppositions or best guesses are used to develop any budget.

Using this article as an example, Figure 4.1 shows the total goat numbers on a farm resulting from the

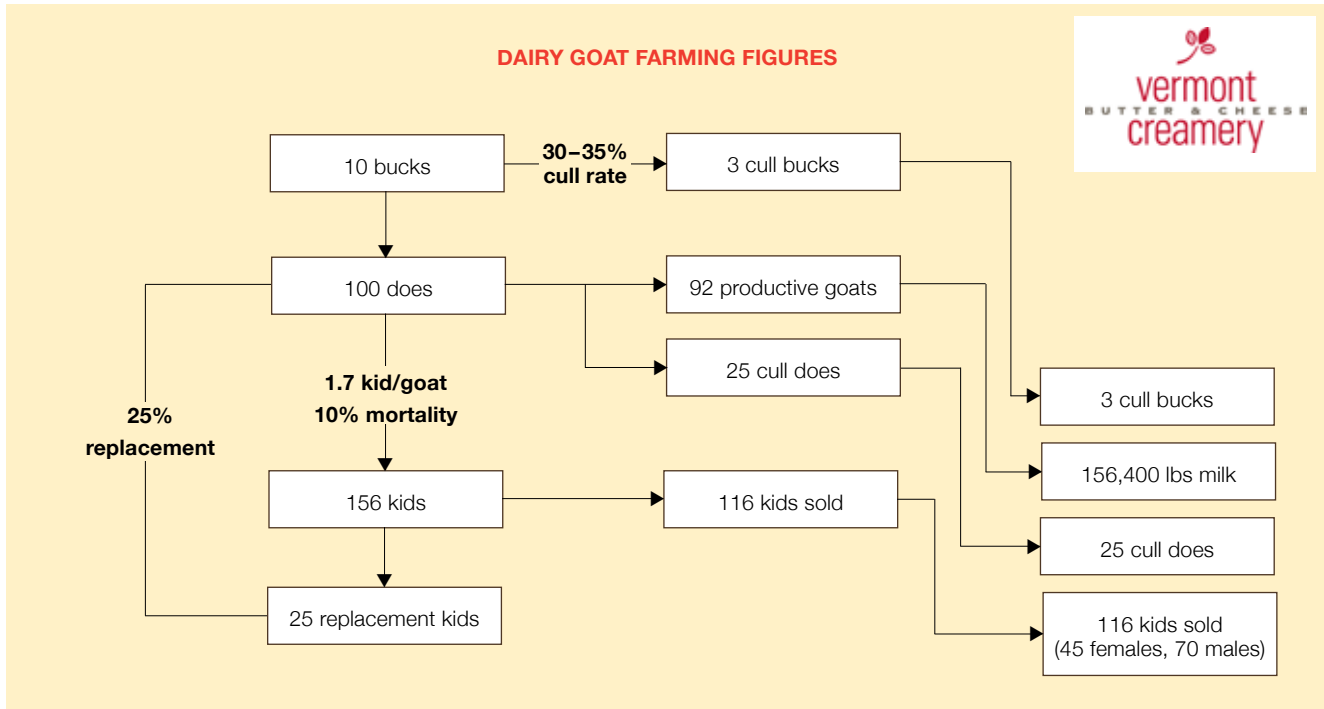

Figure 4.1 Total goats on a 100 dairy goat farm.²

stated assumptions for a herd of 100 milking dairy goats.

At the end of financial analysis, presenting the information on a per goat basis is a common way to look at the profitability of the herd. This will mean that all income and all expenses are put on the “backs” of the milkers. All the costs of the bucks and kids and growing replacements need to be supported by the income from the does and other sales. For example, if it costs \$200 in feed and supplies to raise a replacement for 12 months and there are 25 replacements for 92 productive milkers then, the per goat cost of raising replacements is $\$200 \times 25 / 92$ productive does = \$54/productive milker for replacement cost. This could be a useful Annual Progress Indicator to monitor, as mentioned at the end of Chapter 3.

Start-up Cost Figures and Assumptions

If there is capital, i.e. money, to invest in the farm, list that as a resource. If there are buildings and land, those are assets, too. Many people start out owning a barn and ask how many goats can they house? Table 4.1 provides the square feet recom-

mended for each age category of goat. Depending upon the type of feeding system, allow 6–16 square feet per goat for the feed alley (where the feed and feed delivery and clean up system is). Allow about 200 square feet each for the milking parlor and milk house. See Appendix 4 for examples of barn layouts and parlor sizes and Chapter 10 for a small barn set-up.

The purchase of equipment will contribute to start-up costs and annual fixed costs in the enterprise budget if a loan is taken. Farm loans from federal programs are usually low interest in compari-

Table 4.1³
Basic floor space recommendations
for different ages of goats

Age Group	Floor Space (sq. ft.)	Linear Feed space (in.)
< 1 month	2.7	8
1–2 months	3	10
2–7 months	9	13
7 months–kidding	12	15
Adult	20–30	16

son with commercial bank loans. However, banks consider a debt to asset (D/A) ratio of 50% or more to be risky⁴. A wise farmer is averse to accumulating a large debt that will be difficult to repay and will use savings instead of borrowing money. The USDA Risk Management Agency (See Appendix 3) provides insurance coverage for crops and livestock on diversified farms to buffer any change in revenue due to natural disaster and fluctuations in markets.

In 2007, speaking at a workshop in Burlington, Vermont, Keith Kirchner, Vermont dairy goat farmer and consultant for farm and cheese start-up businesses (see Cheese Products Consultants in Appendix 1), gave this list of start-up equipment to consider in Table 4.2.

Enterprise Expenses: Variable and Fixed Costs

The everyday inputs or variable expenses that get used up are separated from fixed expenses like

truck payments, insurance, property tax, rent, utilities, accounting and, sometimes, labor.. The variable expenses will change when the number of goats changes so that is why they are listed as a group. Fixed costs need to be paid no matter how many goats are milked and are listed separately for that reason. For a start-up budget, all the expenses are listed, including variable, fixed and initial capital purchases like goats or equipment.

For example, feed inputs vary each year depending upon the number of goats and how much is fed. Supplies that can be used more than once but are under \$100, like ear tagging equipment and other small tools, like a hammer can be placed under variable expenses (supplies) because they are replaced on a regular basis. Rodent control and accounting could cost the same no matter the number of animals so they would fall under the category of fixed overhead expenses. Some actual variable expenses and some overhead services on a small dairy are presented in Table 4.3.

Table 4.2
Equipment list and start-up costs for a 50 milk goat dairy

Equipment, Used in Good Condition	Estimated Cost	Installation Cost
Haying: baler/kicker, tedder, rake, 2 wagons, mower	\$12,000-15,000	
Small skid steer	\$3,000-6,000	
Manure spreader	\$1,000-3,000	
Pipeline/washline	\$6,000	\$3,000
Claws/shells/inflations	\$250/milk station	
Bulk tank/compressor	\$400-6,000	\$1,000
Heat recovery unit	\$3,000	additional
Grain bin	\$1,000-2,000	
Milking stanchions — 6 goats	\$1,000	
Commercial water heater	\$2,500	additional
Fencing	\$2/linear foot	additional
Truck		
Livestock		
Tractor, 50 HP, 2WD		

Table 4.3
Listing of variable and fixed overhead costs
on a 50 goat dairy, Keith Kirchner, Vermont

Expense	Estimated cost
Repairs and maintenance	8% of gross sales
Cleaning chemicals, buckets, and pipeline	\$200/month
Utilities— electric	
Propane	\$200/month (with no heat recovery unit)
Heating of parlor and milk room	\$150/5 months
Rodent control	\$500/year
Accounting	\$500/year
Veterinary visits (2/year), medicine, dewormers	\$2,000/herd/year or \$40/dairy goat
Minerals and supplements (includes kelp)	\$120/month
Bedding, 400 cubic feet/month	\$110, delivered
Taxes	
Insurance	

Vehicle Expenses

For trucks or cars, expenses include all the maintenance, repair and fuel costs. The IRS will give a choice to use actual expenses or choose a mileage rate for the expense. Even though it is useful to know how the IRS asks for financial information, the budget process here is for the farmer to realistically create an actual cash flow picture for a year of farming.

Feed Expenses

At this point, figures for hay and concentrate are a big part of the budget. For a herd of 100 milking goats with all the bucks and replacements, rough feed use levels of 20 bales per day or 128 tons per year and 46 tons of grain can be used. These figures are based on the calculations below that can be employed to build feed uses for any size herd. Whatever rates of feed intake are used, be sure to include some figure for waste. Here, 3% of body-weight is used for dry matter intake for the goats for

forage because, even though the goat can consume over 5% during high milk production, the remaining portion is usually made up of concentrates fed.

Daily dry hay usage calculations:

1. Dry matter and as-fed intake of hay —
 130-pound goat eats 3% of body weight per day in hay dry matter (DM)

$$130 \times .03 = 3.9 \text{ lbs hay DM} = 1 \text{ lb. waste} = 4.9 \text{ lbs DM}$$

$$1 \text{ pound of hay is } 90\% \text{ DM (or } 10\% \text{ water) so, } \\ 4.9 \text{ pounds DM} / .9 \text{ pounds per pound as-fed} \\ = 5.4 \text{ pounds hay as-fed / goat per day}$$

2. Goat numbers to use for a 100-goat milking herd

$$92 \text{ milkers, } 8 \text{ dry goats, } 4 \text{ bucks} = 104 \text{ goats}$$

$$104 \text{ adult goats} \times 5.4 \text{ lbs of hay per day} = \\ 562 \text{ lbs of hay / day}$$

$$562 \text{ lbs of hay} / 35 \text{ lbs per bale} = 16 \text{ bales / day}$$

3. Intake of replacement animals

Add a general average of 3 pounds hay per day per any age replacement animal, including waste and assuming 35 animals from birth to first kidding age, thus,

$$35 \text{ kids} \times 3 \text{ lbs hay / day} = 105 \text{ lbs} \\ \text{or } 3 \text{ more bales / day.}$$

4. Totals

$$16 \text{ bales (adults)} + 3 \text{ bales (replacements)} = \\ 19 \text{ bales per day}$$

Add one more for bad hay or other losses.

$$20 \text{ bales per day per } 365 \text{ days} \\ \text{(assuming a confinement herd)} = \\ 7300 \text{ bales or } 128 \text{ tons}$$

$$7300 \text{ bales} \times 35 \text{ lbs per bale} = \\ 255,500 \text{ lbs} / 2000 \text{ lbs per ton} = 128 \text{ tons}$$

Hay Storage

To control the variability in hay prices through the year, it would be good insurance to plan for a storage facility that is large enough to contain one year's worth of forage. This holds true for farms that harvest their own feed or purchase feed. If the herd grazes and browses, then this storage area could be decreased by up to 25%. For our purposes, we will assume that all the forage consumed is mechanically harvested. If the farm lacks enough storage then the cost of construction of a storage facility should be added into the start-up costs.

Storage for hay is about 1 cubic foot (cu. ft.) for 6–8 lbs of hay. Total storage would be

$$255,500 \text{ lbs hay} \times 1 \text{ cu. ft.} / 8 \text{ lbs of hay} = \\ 32,000 \text{ cu. ft. or a room with dimensions:}$$

40 ft. wide \times 80 ft. long \times 10 ft. high barn hay mow
or

40 ft. wide \times 40 ft. long pole barn, stacked 20 ft. high

Grain intake calculations:

1. Milker grain intake assumption is grain fed for 9 months of milking and the last month of gestation.

$$130 \text{ lb. goat} \times 2.5 \text{ lbs as-fed grain/day} \times 305 \text{ days} \\ = 750 \text{ lbs}$$

$$100 \text{ does} \times 750 \text{ lbs per year} = 75,000 \text{ lbs or } 37.5 \text{ tons}$$

2. Replacement grain intake

$$35 \text{ replacements} \times 1.25 \text{ lbs grain per day} \times 365 \text{ days} \\ = 15,970 \text{ lbs}$$

$$15,970 \text{ lbs} / 2000 \text{ lbs/ton} = 8 \text{ tons}$$

3. Buck grain intake

$$4 \text{ bucks} \times 1 \text{ lb. grain/day} \times 120 \text{ days} \\ (\text{during breeding}) = 480 \text{ lbs or } .24 \text{ lbs}$$

4. Total grain

$$37.75 \text{ tons (does and bucks)} + 8 \text{ tons (replacements)} \\ = 46 \text{ tons (including some waste)}$$

To get the bulk grain price, a 3-ton bulk bin should be erected which will ensure fresh delivery about every 3–4 weeks. This is a reminder to add the cost of a grain bin into capital investments made.

Bedding

About 2.2 pounds of straw or 1.1 pounds of dried shavings is recommended per dairy goat per day. From table 4.3, about 8 cu. ft. of wood chips/shavings per dairy goat per month were used on one farm. Use current prices to build a budget. If there is no storage for bedding on the farm, a covered area for one month's supply of bedding is the minimum size recommended for construction. From Chapter 9, an estimate of \$15 per square foot is given for construction costs of a pole building. Using this figure, a 12-foot \times 12-foot shed that is tall enough to handle a 6-foot-high stack of chips or shavings would cost about \$2200 to build.

Labor Expenses

For 100 goats, one estimate⁵ is that it requires the efforts of 1 full-time and one half-time person. If the part-time or full-time help will be hired, there are expenses above just the hourly wage or salary. A nice tool available to help calculate and keep track of this is called the Payroll Calculator[©], a companion CD available with the purchase of a book by Richard Wiswall⁶. It is an MS Excel file with a series of spreadsheets that will help you with the total payroll expense per employee. It allows for entries of hours and hourly rate and then adds in calculations for state, federal withholding, social security and Medicare taxes to collect, which the employer is responsible to hold and send in to the state and federal government on a quarterly basis. A sample blank spreadsheet taken from it is shown in Figure 4.2.

When hired labor is used, there are state requirements for the employer to buy workers compensation insurance. It is there to protect and to compensate employees from personal injury arising from accidents at work and to protect employers from lawsuits that may arise from these accidents. This expense is often a surprise to many new employers

Employee gross pay, taxes and net pay for semimonthly payroll								
Date	Hours	Wage	Gross Pay	Fed W/H from IRS tax tables	SS .062	Medicare .0145	State W/H from state tax tables	NET PAY
1/15			0.00		0.00	0.00		0.00
1/31			0.00		0.00	0.00		0.00
			0.00		0.00	0.00		0.00

Figure 4.2 Payroll Calculator© spreadsheet sample on payroll estimates.⁶

and the amount is significant enough to prepare so, contact your state’s department of labor for details.

Milk Metering

It is important to know how individual goats are performing, not only in milk produced but the amount or percent of protein and fat. These nutrient components, especially the protein, often form the basis of the price because they are correlated with cheese production. Thus, call a service like DHIA or DairyOne to get estimates on the cost of milk metering. Until a formal estimate is made, some use \$20–30 per goat per year for full service animal recordkeeping and milk metering.

Other Variable Expenses

There is a wide variation in utility costs because equipment efficiency varies, as does the cost per KW in different locales. It would be best to call around to area farms to find out what they use and pay. Veterinary expenses can vary a lot with some actual and estimates ranging from \$10 to \$40 per goat per year. It would be good to separate out normal health supplies like vaccines, antiseptics, antibiotics, hi-dose mineral and vitamin supplements, as a supply category. Visits from the veterinarian, veterinary-prescribed drugs or any special treatments for disease or injury should go in their own category so the cost of illness can be monitored. Transportation costs for the pick-up of milk sold is a significant expense. Based on the fees of the purchasing company, it is usually based on a stop fee plus a cost per

weight of milk collected. As mentioned in Chapter 2, in 2006, it ranged from \$3/cwt to \$15/cwt of milk when comparing a 40-goat dairy to a 200-goat dairy both shipping milk to a milk processor in Vermont.

Expenses: Capital Costs

Livestock and equipment purchased are considered capital costs. With land and buildings, these are listed on the balance sheet, which is, essentially, the list of assets and liability for the farm. Another way to look at the balance sheet is that it can be used to see what would be left over (equity) or owed (debt) if every asset were sold and all the loans and credits paid. It can be used to calculate net worth.

Listing the large equipment, building, and livestock purchases shows the required investment costs. The next step is to decide what personal resources are available to purchase these and what debt will need to be incurred. Other than land, these capital investments are recorded on a list that with the cost of purchase and the date of purchase because these items are depreciated for tax purposes. Remember this includes livestock which have a suggested lifespan of 5–7 years.

Revenue

The main income from most dairy goat farms comes from the sale of milk or sale of cheese. The estimated annual level of milk production per goat should be based on the history of the goats purchased. If that is not available, a conservative estimate will have to

Table 4.4
Income categories

Revenue items from 100 goats	Amount (lbs or number head or hours)	Value of Unit (\$/lb, head or hours)	Total Revenue
*Milk, wholesale (lbs)			
Milk, raw milk, sales			
Cheese (see Chapter 2) (lbs)			
Number of cull goats			
Number of meat goats, raised			
Number of breeding stock			
Custom work by farmer			
Other, land rental, hay sales, breeding fees			

*If you are feeding goat milk to the kids or using it for home consumption or raw milk sales, make sure the amount of wholesale milk for sale is adjusted or the other uses are accounted for.

be employed. In a study that measured milk production on 6 Vermont dairy goat farms using DHIA milk metering services, the average milk production per goat in the years 2005–2006 was 1650 pounds per year. Most herds had 9 month lactation (270 days) +/- 1 month. In general, use lower milk production if low grain feeding is desired (2 pounds or less per day per goat) or if most of the milkers are first time fresheners (up to 20% less production in the first year). Use a higher milk production average if the starter herd is comprised of proven animals (purchased from a farm that uses milk recording, practices good sire and dam selection, and has CAEV-free tested goats) and over 2 pounds of grain is fed per day to the milkers.

These totals of the revenue and receipt categories will depend upon the number of animals, the production levels and the price per pound of product. For income and expense tables, list the number of goats it is based on and the unit price of the product. That information will allow income on a per goat basis to be determined.

Enterprise Budget Calculations

The final goal of collecting figures for all revenues and expenses is to create a financial analysis of the start-up year of the business and to predict the following 5 years of income. Table 4.5 shows the com-

Table 4.5
Listing and definitions of financial analysis terms

Income	All revenues related to farm
Expenses	<p>Variable – supplies, vehicle and equipment fuel, maintenance and repair, feed, utilities, guard dog feed, fence repair and supplies, minerals and supplements, veterinary service and medicine, health supplies, feed, custom trucking or work, hourly labor, fertilizer, consulting fees, marketing, milk shipping fees, etc.</p> <p>Fixed overhead – monthly rent, insurance, taxes, annual fees, interest on loans (accounting, rodent control, dairy licensing, etc.)</p> <p>Fixed – non-cash: depreciation on equipment, buildings and purchased livestock</p> <p>Labor for owner – salary</p>
Enterprise Income Statement	Revenues minus all operating (variable and fixed overhead), interest and depreciation expenses
Return to labor, capital and management	Revenues minus operating, fixed and salary expenses
Break-even quantity of milk (lbs)	Total fixed cost per year/(price per lb of milk – average variable cost per lb of milk)
Break-even price	(Average variable cost per year + total fixed cost per year)/sales per year

position of revenues and expenses, taken from previous discussion, used for an income statement and the return to capital, labor and management analysis. More revenue and expense categories can be added as needed.

Break-even Analysis Calculations

The other manipulation of the figures that is useful is a break-even analysis.⁸ Once the price per unit of product, variable expenses, fixed expenses, amount of product produced and number of live-stock needed to produce this amount are known, it is easy to calculate when the income equals the expenses. One can use it to find the number of animals needed or amount of milk sold to break even and the price needed for milk to break even with the current expenses.

A sample calculation of the break-even price per pound of milk is:

$$P = (AVC + TFC)/S$$

where

P = price per unit

AVC = Average variable cost per year

TFC = Total fixed cost per year

S = Sales volume per year

Thus if, you had a 100-goat dairy with 92 goats producing 1600 pounds each, that would be 147,200 pounds of milk sold from the farm. If the annual variable cost was \$40,000 and the fixed cost was \$20,000, the price required to break-even price needed to cover costs would be:

$$P = (40,000 + 20,000)/147,200 = \$0.41/\text{lb of milk}$$

Thus, to cover the cost of the expenses with nothing left over for salary, the farmer would need to get \$41 per cwt of milk.

To find out the break-even quantity of milk per goat, the formula to use is:

$$Q = TFC/(P - AVC)$$

where

Q = quantity of milk

TFC = total fixed cost or \$20,000

P = unit price paid for product or \$0.50/lb

AVC = average variable cost/lb. milk or
 $\$40,000/147,200 = \$0.27/\text{lb}$

In this case, if the price paid per pound of milk was \$0.50, and the variable cost was \$40,000 and the fixed cost was \$20,000.

$$Q = \$20,000 / (\$0.50 - \$0.27) = 86,957 \text{ lbs milk}$$

If 92 goats are to produce, this would be 945 pounds milk per doe. Thus, that is the break-even amount of milk needed to pay the expenses in this example on a per doe basis. If 1600 pounds is the actual amount produced from a 9-month lactation, that comes out to an average of 5.9 pounds per day. For 945 pounds in lactation over 270 days, the average daily production of the break-even quantity is 3.5 pounds of milk per day. So, once a doe produces 3.5 pounds of milk per day, she has covered the costs and anything more goes toward profit and salary.

Tools for Building the Budget

Gary W. Rogers created a budgeting spreadsheet tool for starting a dairy sheep operation and presented it at the 2008 Dairy Sheep Symposium.⁷ It allowed him to manipulate the herd size of the enterprise, select the assumptions and enter financial figures. Figure 4.3 is a rendition of this spreadsheet changing the entries to represent a dairy goat enterprise. Use this as a basis for creating your own budgeting spreadsheet tool and customize it to fit your situation.

Resources on enterprise budgets specifically for dairy goats are provided below.

ATTRA: Dairy Goats: Sustainable Production

WWW.ATTRA.NCAT.ORG/

California, A Sample 500-Goat Dairy Budget

WWW.AGMRC.ORG/MEDIA/CMS/

DAIRYGOATSNC05R_561E506BD07C6.PDF

Langston University, Goat Farm Budgeting

WWW.LURESEXT.EDU/GOATS/LIBRARY/FIELD/

SAHS03.PDF

CALCULATION OF RETURN TO LABOR & MANAGEMENT FOR A DAIRY GOAT OPERATION

Information About Your Herd		
Number of does in the herd		
Number of does desired for the following year		
Percentage of does kidding		
Average number of kids born per doe		
Percentage of dead kids		
Percentage of doe loss		
Percentage replacement		
Number of bucks		
Number of doe kids sold for breeding		
Number of buck kids sold for breeding		
Average weight of kids at sale		
Average weight of does		
Average milk production per doe (pounds)		
Average # of does milked per hour		
Average set up and cleaning time before and after each milking		
Average # of days each doe is milked		
Percentage of milk sold		
Herd Results		
Number of kids born		0
Number of kids raised		0
Number of replacement doe kids to keep		0
Number of kids for sale		0
Number of kid sold for meat		0
Number of cull does		0
Number of does milked (90% of total does)		0
Minimum number of acres of improved pastures (8 does/acre)		0
Price of Products for Sale		
Price of kids at sale per pounds		
Price of breeding doe kids		
Price of breeding buck kids		
Price of cull does per pound		
Average price of fresh milk per pound		
Average price of cheese per pound		
RECEIPTS		
kids sold for meat		\$ -
doe kids sold for breeding		\$ -
buck kids sold for breeding		\$ -

If increasing herd
Find local values

Replacement doelings are put at
breeding at 7-10 months of age

Will vary if kids sold as week-olds,
holiday kids or larger slaughter
kids

}

} This will determine the amount
of hired labor for milking

}

Figure 4.3

Fresh milk	\$	-	
Cheese			
Culled does	\$	-	
Other income			
Other income			
Total receipt	\$	-	

VARIABLE EXPENSES				
Doe Feed	Quantity	\$	Unit	
# months on pasture			month/doe	\$ -
# months average quality hay (3% DM intake)			month	
Tons of average quality hay needed and price			ton	\$ -
# months good quality hay (4% DM intake)			lb	
Tons of good quality hay needed and price			ton	\$ -
# months average hay for bucks (5lb/day/buck)			month	\$ -
Tons of average quality hay for bucks and price			ton	\$ -
# months grain for bucks (2lb/day/buck)			lb	\$ -
# months grain at 1 lb/day/doe			lb	\$ -
# months grain at 2 lbs/day/doe			lb	\$ -
Mineral 20 lbs/doe/year			lb	\$ -
Total Doe Feed				\$ -

Kid Feed	Quantity	\$	Unit	
Creep feed			lb	\$ -
Finish ration			lb	\$ -
# days on pasture			day/kid	\$ -
High quality hay for replacement does (2.5 lb for 120 days)			ton	\$ -
Grain for replacement does (1 lb for 120 days)			lb	\$ -
Milk replacer			lb	\$ -
Total Kid Feed				\$ -

Other Expenses	Quantity	\$	Unit	
Hoof trimming			/doe	\$ -
Marketing-trucking			/doe or kid	\$ -
Milk production testing (# of times tested)			/doe/time	\$ -
Vet-Med			/doe	\$ -
Supplies goat			/doe	\$ -
Supplies milking			/doe	\$ -
Bedding straw (lb/doe)			/lb	\$ -
Electricity				\$ -
Machine operation cost				
buck cost (1/3 of bucks changed every year)				
Maintenance and repair				
Vehicle expenses				
Hired labor for milking (hours)			/hour	
Hired labor for other (hours)			/hour	
Unplanned and unforeseen expenses				
Other Equipment rental				
Other				
Interest on operating loan				
				\$ -

Total Variable Expenses	\$	-
--------------------------------	-----------	----------

FIXED EXPENSES					
	Investment	Terms	Interest %	High Debt	Low Debt
Farm payment					
Livestock					
Sheep Equipment					
Buildings					
Milking equipment					
Freezer					
Pick up truck (used)					
Machinery					
Feed storage					
Property Taxes					
Insurance					
Total					

RETURNS		High debt	Low debt
Total Income		\$ -	\$ -
Less Variable Expenses		\$ -	\$ -
Return to Labor and Capital		\$ -	\$ -
Less Fixed Expenses		\$ -	\$ -
Return to Labor and Management		\$ -	\$ -
Per doe			

Wisconsin Dairy Goat Association, Dairy Goat Management: Best Management Practices
WWW.WDGA.ORG/WIDAIRYGOATASSOC/RESOURCES+FOR+FARMERS/PUBLICATIONS.ASP

ENDNOTES

1. Building a Sustainable Business: A Guide to Developing a Business Plan for Farms and Rural Businesses. SARE Handbook 6. Available for order or free download at www.sare.org/Learning-Center/Books
2. Provided by Jordan Le Roux, Vermont Butter and Cheese Creamery, See Appendix 2, 2005 Dairy Goat Budget.
3. Le Logement des Troupeaux Caprins Du Centre Ouest, Octobre 2006, L'Association Régionale Caprine Poitou-Charente et les autres.
4. Robert Parsons et al., Profitability of Small Ruminant Farmstead Dairy Processing Operations, Proceedings

of the 11th Annual Great Lakes Dairy Sheep Symposium, 2005, Burlington, Vermont, pp. 27–35.

5. Linda Coffee et al., Dairy Goats: Sustainable Production, Livestock Production Guide, ATTRA, 2004. WWW.ATTRA.NCAT.ORG/ATTRA-PUB/PDF/DAIRYGOATS.PDF
6. Richard Wiswall, *The Organic Farmer's Business Handbook*, Chelsea Green Publishing, White River Junction, Vermont, 2009.
7. Gary W. Rogers, Economics of Converting a Cow Dairy to a Sheep Dairy, Proceedings of the 14th Annual Great Lakes Dairy Sheep Symposium, 2008, Maryville, Tennessee, pp. 9–11. Email contact: GROGERS200@YAHOO.COM
8. Gilbert L. Queely, An Enterprise Budget for Meat Goat Producers, presentation at the National Goat Conference, Tallahassee, FL, September 2010. Presentation available at WWW.FAMU.EDU/CESTA/MAIN/INDEX.CFM/COOPERATIVE-EXTENSION-PROGRAM/AGRICULTURE/SMALL-RUMINANT/ABOUT-THE-SMALL-RUMINANT-PROGRAM/



Using VT DHIA Herd Management Records

Mildred Nault

Editor's Note: The Vermont Dairy Herd Improvement Association (VTDHIA) or DairyOne are examples of milk production and milk sample testing services that provide record keeping services. From their range of menu of options, a farmer can actually borrow meters and do the milk production testing themselves and choose to have milk samples from each goat taken and analyzed for percent of fat and protein, other solids and somatic cell count (SCC) or milk urea nitrogen (MUN) levels. Or, they can pay to have trained technicians come to their farm to do that work. Then, there are different levels of records and programs that organize all this information for the farmer. This can be as simple as a one page print-out of the results from that test date or it can be in the form of keeping track of every goat in a herd management software program; in the case of VTDHIA, it is called PCDART. The farmer can purchase the software program and pay for support so that they can have access to all records at all times from home and create reports based on parameters they choose. Thus, testing the milk production of the goats is not only to see how much milk each one is producing for selection purposes, it can offer a whole herd record keep-

ing system that includes health and growth records for individuals.

VTDHIA offers services that can be mixed and matched to suit a producer's unique needs. They include:

- running milk samples collected by a producer fat/protein and/or somatic cell. MUN and bacterial testing are also available to producers using our lab;
- facilitating a producer's collection of data on their animals such as kidding dates, dry dates, sold dates, breeding information, ID information, health information and storing that information on a regular basis to create a history on individual animals and on the herd of animals. This information can be sent to us and processed records returned to the producer;
- providing a trained technician to input the collection of data and samples;
- training on PCDART herd management software that allows the member to have "real-time" status information on their herd at all times.



Photo 5.1 (LEFT)
Technician setting up milk meters in parlor so meters are level.



Photo 5.2 (RIGHT)
Technician taking a milk sample in vial from milk meter.

Reasons Goat Producers Use DHIA Records

1. Lab results give useful snapshots and trends

- fat/protein inversions in the first 30–40 days may indicate feeding problems. (When the measured fat % in the milk drops below the protein%, that is usually an indication of a lack of fiber or other problems in the diet.);
- 90% of milk check is based on milk components. Current and historic trends on individual animals, groups of animals and the herd can help the producer choose which animals to cull and who to breed animals to;
- current and historic trends in somatic cell on individual animals and the herd can help determine udder health issues. Low somatic cell premiums are available from many creameries. Knowing which animals contribute to a herd's somatic cell can help the producer stay within in the legal limit.

2. Records are invaluable for herd management

- quick lists of animals that need to be bred, calving, to dry off, considered as culls, high somatic cell, etc.;
- production, udder health, reproduction and culling trends can be tracked on individual animals, groups of animals, or the herd;

- peak and persistency of lactation curves help monitor feed programs and management changes;
- success of breeding program can be monitored;
- efficiency of each buck can be monitored;
- efficiency of numerous management changes can be monitored;
- young stock can be tracked — size, breeding information, ID information and age;
- reports show you how many animals will be kidding and in herd each month — helpful when determining expected cash flow, when you can market animals, need to buy animals.

3. Marketing and financial opportunities are gained

- records allow you and the buyer to see how animal is doing;
- publication of herd average (if you choose and are eligible) in Country Folks can attract buyers to you;
- low somatic cell, high fat and protein help you get the most from your milk check.

4. Electronic records are dynamic

- PCDART herd management software and processed records are developed based on producer and consultant requests;
- DHIA records created using PCDART are accessible (if the producer chooses) by consultants, giving them an excellent tool to help with management decisions;

- DHIA records are standardized throughout the country so anyone using them know that they are comparing “apples to apples;”
- records sent through a processing center are backed up so if something dire happens to records at the farm, they can be retrieved;
- records sent through a processing center are invaluable history when producers are involved in a lawsuit;
- using an experienced DHIA technician insures that info is gathered regularly and saves labor on the farm;
- pocketdairy allows individual animal records to be viewed and new information to be input on a handheld wherever the producer is.

SECTION 2

**GETTING
YOUR
GOATS**

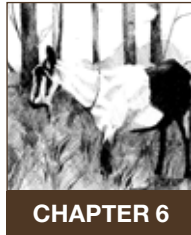

The Feed Costs of Raising Your Own Dairy Goat Replacements

Carol Delaney

One decision a dairy goat producer needs to make in starting a farm is whether to raise their own does from kids or to purchase them. When buying or selling replacements, it is a good idea to have a handle on the cost of raising them to set some sort sale price “floor.” Since feed costs are at least 50% of the total expense of maintenance of an animal, this is a useful figure to know when selling animals, buying in, or having someone custom-raise your replacements.

Let’s calculate feed costs starting from birth until the replacement drops its first kid the next year. We will assume that the replacement doe will freshen at 15 months of age although this time could be shorter or longer. In this example, the goats are confined on hay and numbers are rounded up. So, one could decrease the cost by having the replacement out on pasture and browse.

Replacement Doelings

On average, kids drink about one quart per day of milk or milk replacer (MR) in the first ten days and then from ten days to eight weeks increase to two quarts per day. Thus, a total of 102 quarts or 25.5–26 gallons (1 quarts \times 10 days plus 2 quarts \times 46 days). This is the minimum dry matter intake (DMI),

according to research done at the Goat Research Center at Langston University in Oklahoma. They found that the range of feeding methods they used over an eight week nurse period showed 26–31 pounds of milk DMI with the highest amount on free choice MR. Farmers find the best results in kid health when kids are about 30 pounds in body weight at weaning so you may need to feed milk longer than eight weeks. A dry matter intake of 30 pounds for kids raised on milk replacer or milk will be used here.

Now, 30 gallons is the equivalent of 30 pounds of dry MR at 20–25% protein (this is the percent of the protein in the powder; when mixed, the liquid MR is about 18–25% dry matter so it then dilutes down to about 3.5–4% protein; and fat is 20% of dry replacer so it is diluted to about 4% fat in MR). At retail prices in 2008, MR could cost \$53 plus shipping for 25 pounds from Hoegggers Supply, or over \$2.20 per pound. At one point in 2008, Does Match Kid Milk Replacer™ was selling locally for \$88 for 50 pounds or \$1.76 per pound and Sav-A-Kid™ was \$50 per 25 pounds. Bulk purchases could lower that price a little and some farmers feed calf MR with success. Thus, assuming 30 pounds dry intake of milk to get to weaning at eight weeks, it can cost between \$53–66 per kid in milk replacer.

Table 6.1
Total concentrate fed to doelings from birth to kidding
at 15 months of age in large breed goats

Time Period	% Crude Protein	Calculations of Concentrate Fed	Total Pounds of Concentrate Fed in Time Period
Month 1	16–18	0.25 lbs/day x 30 days	8
Month 2	16–18	0.5 lbs/day x 30 days	15
Months 3–7	14–16	1.5 lbs/day x 150 days	225
Months 8–11	14–16	2 lbs/day x 120 days	240
Months 12–15	14–16	1.25 lbs/day x 120 days	150
450 DAYS		Total estimated concentrate fed	638

If you feed real goat or cow's milk to the kids, you will have to estimate the value of about 258 pounds of milk (30 gallons x 8.6 pounds/gallon of high solids milk) on your farm. If the sale of goat's milk averages \$0.50 per pound, then that is worth about \$129. Or, if you can buy cow's milk at \$3 per gallon, that would cost \$90 to raise a kid before weaning, just in milk cost. (If you do feed cow milk, there is still a risk of transmitting Johnnes disease which is spread by fecal contamination with a paratuberculosis organism. Symptoms include chronic weight loss with or without diarrhea starting at about 2–3 years of age. This disease is not treatable. Heat treating at pasteurization temperatures kills these organisms in the milk.)

Additionally, your replacements will need a concentrate feed for them to grow well in the range of about 488–500 pounds per kid for the first 11 months, according to Dan Considine (Presentation at "All About Goats" at Penn State University on November 4, 2006). Using his figures as a basis, Table 6.1 shows the breakdown of the concentrate input to be expected to raise a doeling.

Considine recommends feeding 2 pounds per day up to 70–80 pounds weight at breeding size and then switching to 1–1.5 pounds of concentrate fed per day until late gestation for the larger breeds. Breeding by 10 months of age (300 days old) and

kidding at 15 months (450 days) means that the total concentrate intake would be about 640 pounds.

The estimated hay intake is 600 pounds per kid for the first 11 months. From months 12–15, their body weight is increasing from 75 pounds up to 110 pounds and the doeling will probably eat about 2.5 pounds of hay per day (or another 300 pounds of hay) until she freshens.

Feeding less concentrate and grazing and/or browsing the doelings can lower the cost considerably. Hay is not as expensive per pound as grain but it is sometimes hard to find good hay to buy if you do not grow it on the farm.

The best milk for kids is from the goat in terms of digestion, but is more expensive. Some farmers

Table 6.2
Grand total estimated feed cost to raise a doeling
from birth to kidding at 15 months of age

Total Feed Inputs (lbs or gals.)	Total Feed Costs (\$)
Milk replacer 30 lbs	53–66
(or goat milk 258 lbs)	129
(or cow milk 30 gals.)	90
Grain: 640 lbs @ 320/ton	103
Hay: 900 lbs @ 150/ton	68
Replacement feed cost range:	\$224–300/kid



Photo 6.1 Group feeding of milk and/or milk replacer using a home-made “kid bar.”



Photo 6.2 Older kids grouped by age in pens with feeders on the outside of the pen for cleanliness and ease of feeding.



Photo 6.3 Four month-old replacement doeling eating a mouthful of bramble.

start feeding the kids goat milk at birth and gradually mix in cows’ milk or milk replacer at a rate of half goat to half other milk to cut down on this cost. Much of the milk harvested from the first few days of milking contains colostrum and is not sold, so it is usually diverted to feed kids anyway. Some processors require that the milk show a “foam” before they will buy it as this indicates it is free from colostrum. Another factor to consider is the external cost of processing and shipping of milk replacer and what is best for the health of the kids.



Photo 6.4 Solar barn for raising kids.

There are a lot of hidden costs that come with grazing, such as fencing, water system, guard animals and de-worming if the kids graze. Everyone needs to add in the other expenses of bedding, hot water, medical supplies/vaccines and labor.

This general analysis is a start for each farm to estimate the input of feed into their replacements. Being able as early as possible to select the animals you want to keep will allow you to focus your resources only on the livestock that will improve your production or income.

The financial viability of raising animals for meat markets should be scrutinized with a budget analysis and these feed costs should help producers analyze

what the market price should be for making a profit. Aside from financial viability, the producer should look at how their own quality of life is affected by the addition of a meat market enterprise.

Weaned kids do very well on browse supplemented with concentrate. Foraging on browse offers good nutrition, is good exercise and prevents internal parasite infestation.

Housing for kids separate from the adult goats, that offers fresh air and sunlight is a very healthy option. The farm in Photo 6.4 set up a solar barn next to their home so they could give the young kids good attention and a very clean environment all year round.



CHAPTER 7

Evaluating Dairy Goats

Carol Delaney

Always visit the goats that you may be purchasing and evaluate the health status of the herd they are from by observation and talking with the breeder. Even if you are purchasing individuals that appear healthy, you can observe or ask whether certain diseases are common to the herd. By viewing the herd, not only will you be able to see their physical attributes, but you can view their behavior as well. They should be curious to see you and not run away or appear afraid of humans (unusual behavior for goats). You can also see how they are handled by the owner and what barn layout has worked for them. If you are only buying a few of the herd, you can at least look for incidence of disease, even if the goats of interest are healthy.

Physical appearance and traits to look for:

- Alert animal with head up.
- Wedge-shaped physique (Figure 7.1).
- Good legs — pasterns are upright at a 45° angle and hindlegs show sufficient bend at the hocks (not too post-like or straightened out) (Figure 7.2).
- Inspect teeth for age determination (Figure 7.3).
- Good mouth — bottom teeth meet pad on roof of mouth (no over- or underbite).
- Teat opening allows good flow of milk —

avoid small openings with noticeably smaller flow amounts because this trait is 65% heritable. (Chapter 14).

- Udder is attached with good support, high enough so the goat can't step on teats, and teat size and placement to allow for easy milking. (Figure 7.4).

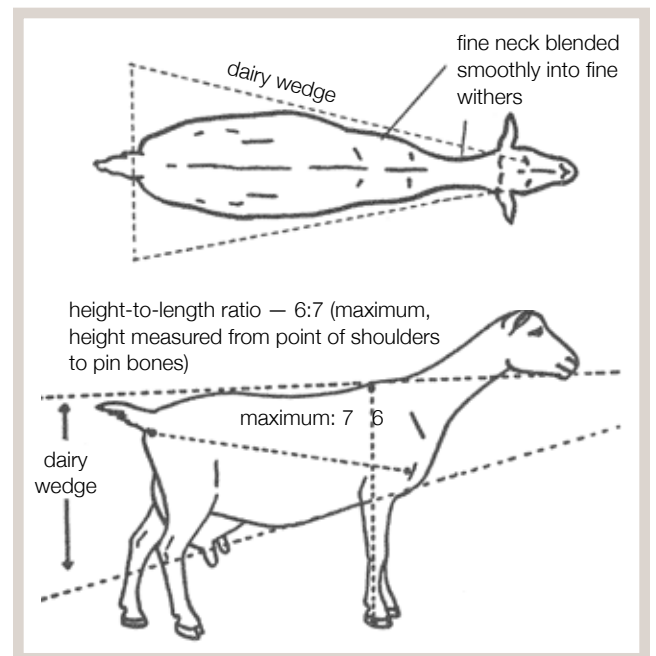

Figure 7.1 Dairy goat wedge shape, used with permission from Pat Coleby's book, *Natural Goat Care*.

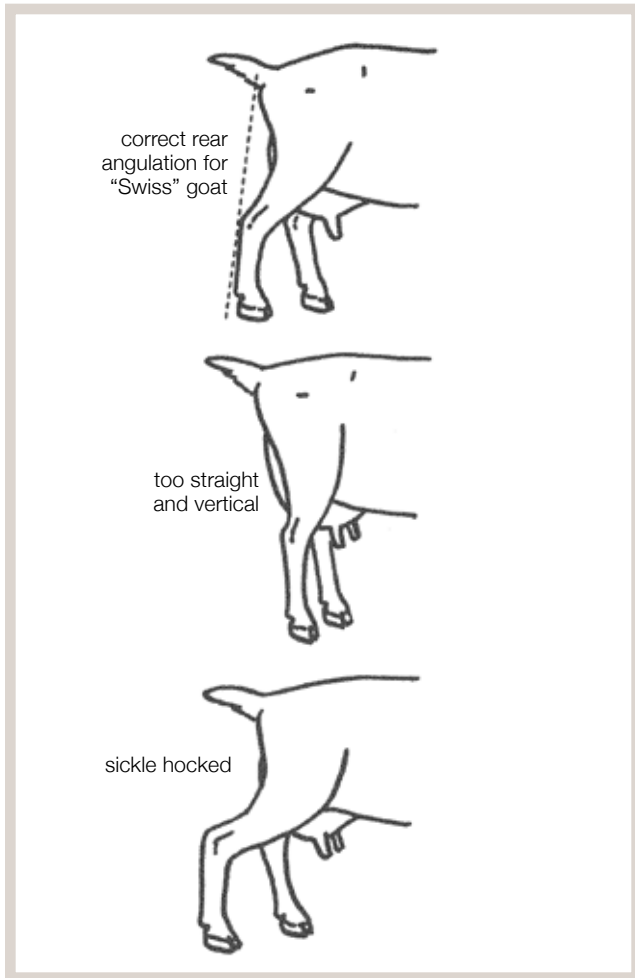

Figure 7.2 Hind leg angle, used with permission from Pat Coleby's book, *Natural Goat Care*.

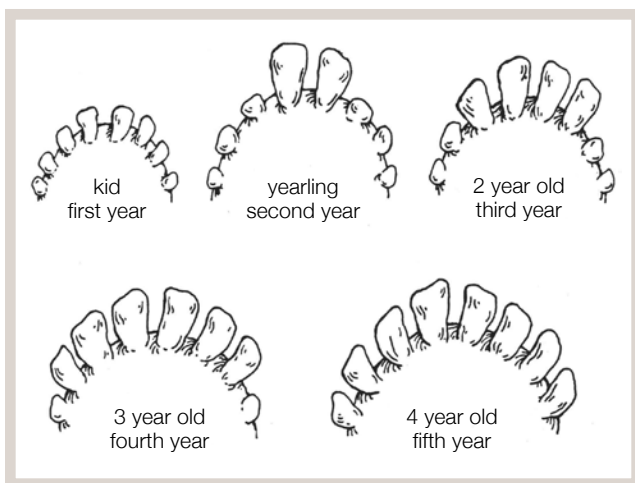

Figure 7.3 Age determination by lower teeth, used with permission from Rosalee Sinn's Heifer International book, *Raising Goats for Milk and Meat*.

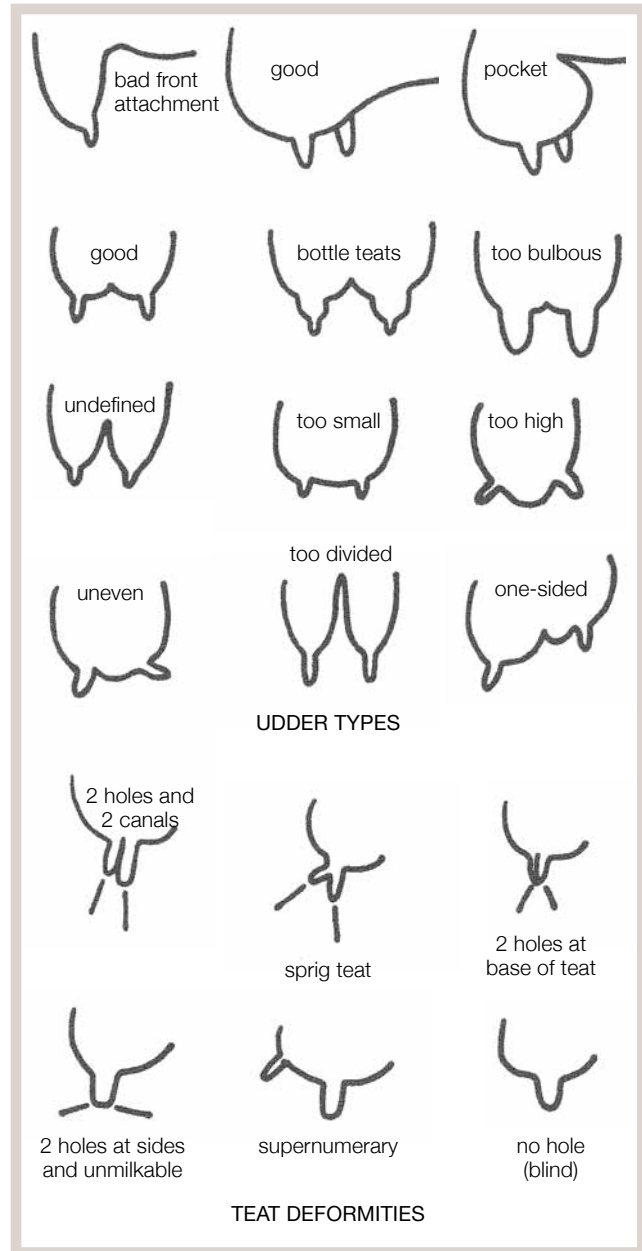

Figure 7.4 Udder form, side views, used with permission from Pat Coleby's book, *Natural Goat Care*.

Written Records to View:

- vaccination and health records like CD&T and rabies vaccines;
- history of mastitis, ketosis, and milk fever;
- kid mortality, weaning age, growth rate, age at first freshening;
- average age of milkers could show longevity of animals;

- milk production from
 - third party milk production measurement like Dairy Herd Improvement Association (DHIA), or DairyOne. Such measurements are the basis for national averages;
 - one year of bulk tank readings coinciding with records of the number of goats milked that week will give an estimate of average production per goat;
 - cheese production records for the year from a recorded number of milking goats;
- breeding and breed registration and kidding records.



Photo 7.1 Example of CAEV infected doe showing arthritis in the knees. Udder scarring is often a symptom. Both reduce milk production.

Health Problems to look out for:

1. Arthritis — Caprine Arthritis Encephalitis Virus (CAEV). See WWW.SHEEPANDGOAT.COM

- This lentivirus (like HIV in humans) only infects goats; infections spread by fluids from infected animals through the mucous membranes. Most commonly spread when the doe licks off her newborn, through her milk when the kid nurses, or when kids are bottle fed infected does' milk. Enlarged knees in adults are a common sign. (Photo 7.1)
- All adult animals need to be tested every year with ELIZA blood test.

- Control by segregating infected animals from herd, removing kids as soon as born and feeding CAE-free or heat-treated milk.

2. Lumps on neck or shoulders — Caseous Lymphadenitis WWW.GOATWORLD.COM/

- Bacterial infection that concentrates in lymph glands mainly under jaw on neck. Can also be on inner organs. Spreads when abscesses burst.

Table 7.1
Milk production yields and analysis of US herds on DHI test in 2007

Breed	Milk lbs in Lactation Average (range)	Butterfat Average %	Butterfat Average Total lbs	Protein Average %	Protein Average lbs
Alpine	2122	3.3	70	2.9	61
LaMancha	1877	3.7	69	3.0	56
Nigerian Dw*	806 (300–1720)	6.6	53	4.3	34
Nubian	1338	4.6	62	3.8	51
Oberhasli	1786	3.6	64	3.0	60
Saanen	2032	3.3	67	3.0	55
Toggenburg	1843	3.2	59	3.0	55

* Nigerian Dwarf figures taken from ADGA registry breed averages.

Body and Breed Characteristics

Mature goats are from 100–200 pounds live weight. Alpines, Saanens and LaManchas are the large breeds popular in the Northeast, but Nubians, also large, are the most popular breed in United States. Other common breeds are Toggenburgs and Oberhasli. The Nigerian Dwarf is a recognized breed with milk more similar in fat and protein to sheep milk (higher solids). Crossbreeds are most popular in commercial herds due to the benefits of hybrid vigor.

The following photos show some purebred dairy goat breeds.



Photo 7.4 Toggenburg, Saltrock Farm, Mosher Island, Nova Scotia, compliments of Anne Drew.



Photo 7.2 Alpine from Oak Knoll Dairy, Windsor, Vermont.



Photo 7.5 LaMancha, Oak Knoll Dairy, Windsor, Vermont.



Photo 7.3 Saanen milking, Berle Farm, Hoosick, New York.



Photo 7.6 Oberhasli herd, Consider Bardwell Farm, Pawlet, Vermont.



Photo 7.7 Nubians in woods, Clear Brook Farm, Sandgate, Vermont.



Photo 7.8a Nigerian Dwarf, Sharon Peck, Willow Moon Farm, East Montpelier, Vermont.



Photo 7.8b Nigerian Dwarf on milking stand, Sharon Peck, Willow Moon Farm, East Montpelier, Vermont.

Milk Production

For expected annual milk yield per doe refer to Table 7.1, Milk Production Yields and Analysis of US herds on DHI test in 2007. By comparison, in France, 2,037 goat herds (many breeds) were recorded for milk production in 2002–2003. Their average milk yield was 751 liters (1712 pounds) for an average 267-day lactation and the solids were 3.08 % for protein and 3.44% for fat.

From reasearch on pasture-based farms from 2004–2007, the average lactation length was 9 ± 1 months. The total average milk production over the entire lactation was 1650 pounds per goat meaning the average daily milk production was 6.1 pounds. The average cost of grain to support the production of 1 pound of milk was $\$0.10 \pm 0.03$.

Conclusion

There is no one breed that will have a guaranteed milk production level or milk protein and fat levels. In each breed there is a range and in each herd there is a range of individuals. Selection is best based on actual records.



Resources for Buying, Selling, and Marketing Goats and Meat in the Northeast Region

Carol Delaney

A Strong Recommendation

DO NOT BUY GOATS AT AN AUCTION. THIS IS OUR BEST ADVICE TO HELP YOU PREVENT THE INTRODUCTION OF DISEASE TO YOUR FARM. ANIMALS AT AUCTION ARE USUALLY CULL ANIMALS WITH PROBLEMS.

Canada — importation of breeding stock is currently prohibited until the border re-opens to ruminants, large or small. Only slaughter stock is allowed to cross. Talk to your area federal Veterinary Services:

Import/Export Program
Main: (301) 734-8364
Import/export email: VS.LIVE.ANIMAL.
IMPORT,EXPORT@APHIS.USDA.GOV

Classifieds/Listserve/Publications

Get on the Northeast Small Ruminant Listserv:

SRMARKETING-L@CORNELL.EDU
tatiana Stanton
TLS7@CORNELL.EDU
WWW.SHEEPANDGOATMARKETING.INFO

You can list what you are looking for or watch for sales.

Go to website WWW.GOATSHEEPMARKETING.INFO to place your ad or look for ads.

Agriview — Twice monthly publication of the Vermont Agency of Agriculture, Food and Markets:

TERESA@AGR.STATE.VT.US
802-828-2416 for ads
WWW.VERMONTAGRICULTURE.COM/AGRIVIEWONLINE.HTM

Weekly Market Bulletin

New Hampshire Department of Agriculture
603-271-3788
WWW.AGRICULTURE.NH.GOV/BULLETIN/INDEX.PHP

Vermont Sheep and Goat Association (VSGA)

WWW.VERMONTSHEEP.ORG
Join and use their listserv.
INFO@VTSHEEPANDGOAT.ORG.

State Dairy Goat Associations

New York State Dairy Goat Breeders' Association:
WWW.NYSDGBA.COM

New Hampshire Dairy Goat Association — Newsletter classifieds:

WWW.NHDAIRYGOAT.COM

Southern Vermont Dairy Goat Association

WWW.VTGOATS.ORG

ADGA — American Dairy Goat Association

Members are published in a directory.

WWW.ADGA.ORG

Private herds

Coach Farm, Pine Plain, NY — 800 Alpine herd that sells kids/breeding stock.

WWW.COACHFARM.COM

518-398-5325

Transportation/Trucking

Livestock truckers/dealers — to transport your purchased livestock — are licensed with each state's Animal Health Section.

Vermont: 802-828-2421

New Hampshire: 603-271-2404

Ron Keener, trucker of small ruminants nationally, is often on the road.

WWW.TRAVELWITHRONK.COM

RKEENER@REALTIME.NET

512-259-5098

If you anticipate using this transport service, you need to join the TravelWithRonK group immediately at: WWW.GROUPS.YAHOO.COM/GROUP/TRAVELWITHRONK or by email only (you will not be required to join Yahoo).

Another national livestock trucker who specializes in goats and sheep is Russ Edgar of Edgar Ranch, Fredricktown, Ohio.

RUSS@EDGARSHEEPANDGOATS.COM

WWW.EDGARSHEEPANDGOATS.COM

WWW.EDGARRANCH.COM

Regulations for Importing Breeding Stock

When purchasing sexually intact animals from other states for breeding and production, there is a requirement for a health certificate and a proper identification of each animal. The animals need to come with a health certificate from a veterinarian from the state of origin. The vet where the goats originate would need to contact the state vet for the destination state to find out the health requirements for the purchaser's state.

Kristen Haas, Vermont State Veterinarian

802-828-2426

KRISTEN.HAAS@STATE.VT.US

Vermont Agency of Agriculture, Food and Markets

WWW.VERMONTAGRICULTURE.COM/FSCP/ANIMAL

HEALTH//DOCUMENTS/VERMONTSCRAPIERULE.PDF

Trade Journals

Dairy Goat Journal

WWW.DAIRYGOATJOURNAL.COM

CSYCLASSIFIEDS@TDS.NET

800-551-5691

Breeder and classified ads.

United Caprine News

WWW.UNITEDCAPRINENEWS.COM

EDITOR@UNITEDCAPRINENEWS.COM

817-297-3411

Marketing the Bounty of Kids and Cull Animals: Ideas and Examples

For a farm to be sustainable, good farm stewards take advantage of the reproductive capacities of the land and animals. This is a basic difference between a factory, which must buy finite raw materials, manufacture a product and sell it, and a farm, which relies on the bounty of regrowth and reproduction from living systems. The less that a farm captures this benefit of reproduction, whether it is for self-consumption or for sale, the less profitable and sustainable it will be.

A striking characteristic of goats is their ability to reproduce rapidly. They have a short gestation of 5 months, can start breeding at less than 1 year of age, can breed every year and have multiple births of 2 or more kids per kidding. For example, for every 100 does, one can expect to see 200 kids born each year. If the replacement rate is 25%, then only 25 doelings will be saved and the farm will need to capture the advantage of 175 extra kids.

As mentioned in Chapter 6 on the feed costs of raising replacements, the investment in feed, not to mention labor, supplies and space, is significant in raising kids. It is very important for farmers to plan when and where they will market the abundance of kids from their farms. Unlike for cow farmers who have ready services to pick up their unwanted calves, goat farmers will have to search for a similar service. It may be worthwhile to work collaboratively with other goat farmers to create a good enough supply of kids at one time to make it worth a buyer's effort to pick them up. It works against farm sustainability in the long run to slaughter kids at birth and dispose of them, unused, to avoid addressing this opportunity. It is one of the challenges of goat dairies in northern New England because most of the population does not eat goat meat.

Here are some ideas or options for marketing kids and culls that should be investigated and put into place before the first kidding season.

Technical Support: The best information for regional markets and goat production for meat is Dr. Tatiana Stanton at Cornell University. She moderates a small ruminant marketing list serve and maintains a webpage. She monitors the prices at regional auctions and listserv members trade useful information. She can add you to the listserv. Find her contact information above or in the resource section.

Breeding Stock: If registered or purebred goats are the foundation of the herd and/or good records are kept on milk production, pedigree and other desirable traits, the offspring and adult culls will be much easier to sell. Also, if goats are part of prevention programs for the diseases Caprine Arthri-

tis Encephalitis Virus, Caseous Lymphadenitis, and Johnnes, more people will be interested in purchasing the goats.

Ethnic Market: There is a growing population in Vermont and in the Northeast of people from other countries that eat goat regularly or at holidays. To find the schedule of holidays and live animal markets, go to the website, SHEEPANDGOATMARKETING.INFO. The type of animals desired is described there for each holiday. Most of these markets are close to NY city. There is also a useful list of livestock auctions located in other states and brief details on who to contact and how they operate. For local live animal sales, there is one approved Vermont facility for on-farm slaughter by the person who purchases the goat and that is Winding Brook farm in Morrisville, operated by Arthur Meade. He has worked with the state of Vermont regulators to have his facility be legal. In NY state, on-farm slaughter is more acceptable to state regulators there. Contact your own state's agency of agriculture for regulations for on-farm slaughter for meat sale.

Contracts with Kid Raisers: There is a growing number of businesses taking advantage of the ready supply of young goat kids who are raising them



Photo 8.1 White LaMancha dairy doe with half-Boer daughter in a herd of Boer goats. Notice the hind leg muscling difference. Provided by Dr. t. Stanton.

efficiently to then market them in-state and out of state. The way to create a contract with a business that is taking a risk in developing a market for goat meat is to be a reliable source of healthy, large kids. Develop excellent pregnant doe care, including proper vaccinations and nutrition, which will affect the health of the kids *in utero*. Then, follow that with consistent excellent postnatal care of newborn kid of all kids that includes ensured colostrum feeding and clean, draft free housing. Businesses that take or purchase goat kids rely on a good survival rate for profitability. Another way to become a preferred supplier of kids for meat is to have crossbred kids from large breed dairy goats or to breed yearlings and does that you will not keep kids from with a terminal sire meat buck, such as a Boer. The kids will take on most of the characteristics of the Boer breed and be very meaty.

Raise Kids for Meat: One way to provide goat kids that have better meat carcasses is to breed all the doeling replacements to a meat breed buck, since you can't know which of their kids to keep until after their dam's lactation. Dr. Tatiana Stanton, Goat Specialist with Cornell University says "Boer bucks are excellent choices as clean up bucks to breed to dairy does to produce slaughter kids. They improve muscle thickness and carcass quality noticeably on the first cross and their unique markings of white bodies and darker heads are readily passed on to their offspring making it easy for buyers to identify them as Boer crosses. However, Boer cross does are often disappointing as commercial dairy does. Although individual does can achieve peak daily yields comparable to purebred dairy does, Boer goats are not genetically selected for persistency of lactation and rarely produce comparable 305 day lactation yields. In Photo 8.1, see a LaMancha doe with her half Boer offspring, a doeling, and in Photo 8.2, the doeling's brother.

There have been two Vermont markets for whole carcass young goats of carcass weights from 25–60 pounds (dressing weight is 50% because the legs and heads are left on). Currently, these operations are only familiar with purchasing meat goat genetics. Contact information for Fancy Meats from Ver-



Photo 8.2 Half LaMancha – half Boer blond buckling is a brother to doeling in Photo 8.1. Provided by Dr. t. Stanton.

mont and Vermont Quality Meats can be found in Appendix 1.

Pet Food: One dairy goat farmer raised guard dogs for sale. They used some of their extra kids by slaughtering them at less than a week of age and feeding the skinned carcasses to the dogs and freezing the extra. Pets can eat raw bones without worry of splintering. Pet owners who want to feed a natural diet may be interested in a frozen product. Check your state's regulations for pet food sales.

Develop Goat Meat Products: Look up your local meat processing facility or find a list of facilities licensed with your state's department of agriculture. For example, Vermont Smoke and Cure, a meat processing facility in East Barre, Vermont, is licensed to make and sell meat products like sausages. You may be able to develop a recipe and provide the goats for the product that is sold under the plant's label or as your own product, depending upon your marketing interests and capabilities. One farmer lives close to a slaughterhouse and sends her cull goats there and has the meat ground and sells it this way and as sausage at her vendor booth at the farmers' market. Other listings of meat marketing can be found in Appendix 1, Resources.

However, be aware of some general yield and cost realities. The author raised dairy buckling for

meat. The largest weighed 78 pounds liveweight at about 6 months. It yielded 25 pounds of useable cuts of meat, including some bone in meat. It cost \$100 to purchase (\$1/pound) and raise (not including infrastructure or labor). Add in a slaughter and processing fee of \$65/animal and that makes the meat worth (\$165/25 pounds meat) \$6.60/pound. Adding labor and infrastructure costs could add

another \$2–3/pound thus bringing the total cost before markup to close to \$10/pound. You will have to determine if customers are willing to pay what is reasonable to return money for your efforts. While this is quick math and numbers will vary, one can see that recordkeeping will provide the actual costs and yields. Rely on your figures before investing time and money.

SECTION 3

FACILITIES



CHAPTER 9

Housing and Milking Facilities

John C. Porter

Master Plan

The first step in planning a dairy goat facility is to draw up a master plan. This is simply a layout of the farmstead indicating where the present buildings are located and where future facilities will be. This is essential to ensure that buildings aren't constructed in places that will later be in the way. It also allows for incremental expansion; small units can be built that will become part of larger units in the future.

Master planning procedure:

- Establish a family and business zone.
- Determine herd size and future expansion goals.
- Decide on the type of facility desired.
- Compute sizes of all facilities based on numbers of animals and square footage requirements.
- Identify possible sites, considering such things as overall building sizes, access from the rest of the farmstead, and relationship to existing buildings.
- Sketch tentative layouts for each possible site, using recommended orientation, traffic routes, weather exposure, drainage, waste disposal, and building sizes.

- Select the combination of site and layout that best fits recommendations and your needs.
- Check the layout with family members and employees, Extension specialists, USDA agencies, other farmers, builders, town officials, and public health authorities.
- Keep a copy of the master plan on file and posted on the office wall to use when making future building decisions.

Site Selection

After completing a master plan, the next step is to select the specific site for each building identified in the plan as it is needed. Things to consider when selecting a building site include:

- **Access**
 - Ease of entry from the main road.
 - Provision for large delivery trucks to turn around and unload.
 - Visibility if access by public is important.
 - Area for vehicles to park.
- **Topography**
 - Slopes or drop-offs that can be used to an advantage.

- Amounts of fill needed to create a level site on a slope.
- Limitations of topography on traffic flow between buildings.
- Surface and subsurface drainage as they relate to topography.

- **Orientation**

- Southern exposures can take advantage of winter sun and provide some protection against summer heat.
- Wind currents and storm patterns can determine placement of buildings.
- The position of the building can take advantage of wind currents for natural ventilation opportunities.

- **Utilities**

- Access to electrical lines with adequate capacity to run commercial equipment.
- Location of poles and overhead lines.
- Adequate supply of water capable of piping to present and future buildings.
- Communication lines for telephone and computers.
- Location of gas tanks.

- **Ancillary Services**

- Feed and material storage.
- Waste management.
- Chemical and fertilizer storage.
- Equipment storage and repair.
- Fire protection and security.

Housing

Once a master plan has been developed, the design of new facilities or retrofitting of old ones can be determined. Animal housing should follow some basic criteria of:

- efficient layout;
- accessibility for mechanical cleaning;
- smooth traffic flow;
- straight alleys;



Photo 9.1

- adequate ventilation;
- ability to group or restrain animals.

Old tie-stall dairy barns or other buildings can be converted to dairy goat housing (see Photo 9.1), but new construction has the advantage of being custom built for dairy goat needs. Pole buildings with a metal roof system make very flexible and low-cost housing. The basic concepts of free-stall dairy cattle housing can be followed, and they include:

- an area for animal loafing;
 - daily scrape alley by the feed area;
 - fence line feeder;
 - feed access alley in front of feed line.
- (see Figures 9.1 and 9.2 and Photo 9.5)

Pole barns can be built with posts made of laminated, pressure-treated planks buried in the ground or with native lumber set on concrete frost walls.



Photo 9.2

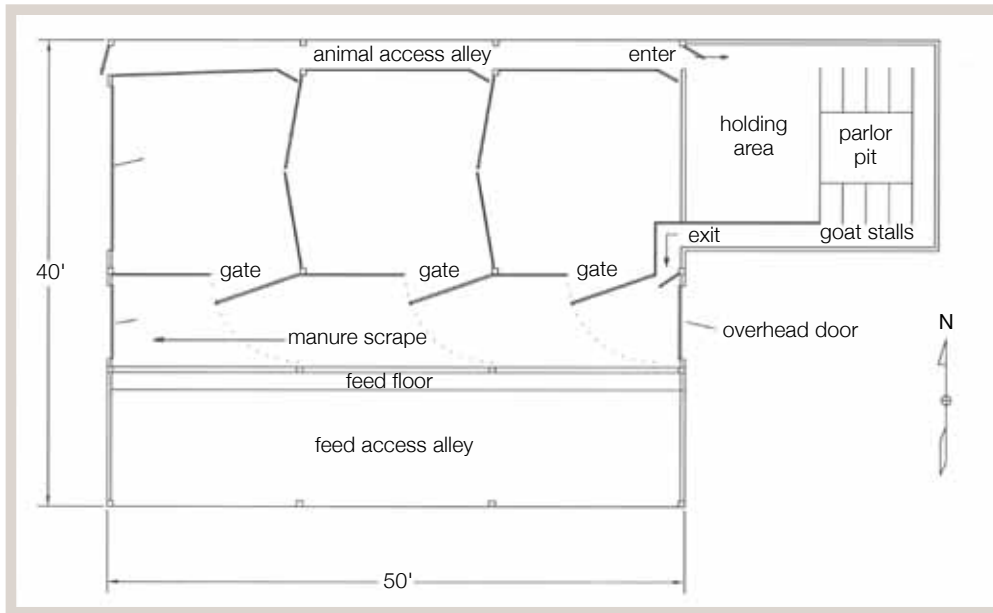

Figure 9.1

Table 9.1
Rough guidelines to help in planning building needs

Item	Space
Loafing area for a mature goat	15–20 sq ft/animal
Feeding area (scrape alley)	8–10 sq ft/animal
Feed access and operation space	10–12 sq ft/animal
Linear feeder space	1 ft/animal
Holding area outside a milking parlor	6–7 sq ft/animal
Grain	45 lbs/cu ft
Baled hay	6–8 lbs/cu ft
Loose hay	3.5–4.4 lbs/cu ft
Sawdust	12 lbs/cu ft
Pasture	.2–.5 acres/animal
Exercise lot	30–50 sq ft/animal
Daily production of manure	.22 cu ft/day/goat
Water consumed	1–3 gal/animal/day, depending on production
Driveway	10–12 ft wide
Doors and gates	10–12 ft wide
Height of building side walls	10–12 ft. high
Maternity pen	25 sq. ft./pen
Waterer	1/25 animals

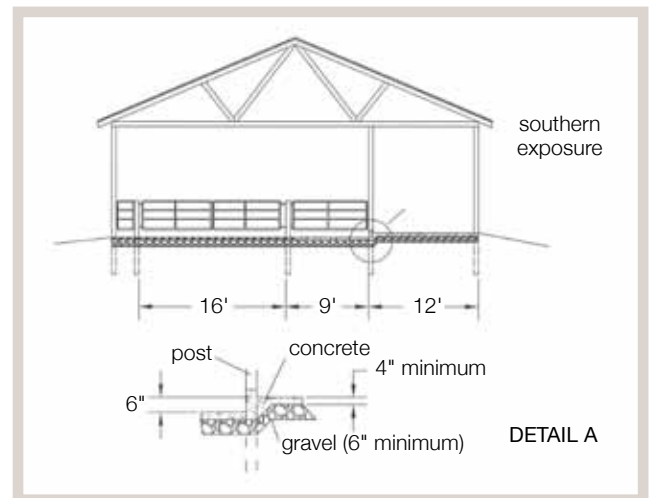

Figure 9.2 Pole barn dairy goat housing

A girder plate is used to tie the top of the posts together. Trusses are mounted on top, so there are no internal posts in the building. The goat loafing area can be gravel, with a concrete scrape alley adjacent to the feed area, a concrete curb to support feed slats, and a concrete feed access alley in the front. Goats need about 15–20 square feet per animal for loafing and another 8–10 square feet for exercise and feeding. A typical floor plan and cross section would be as shown in Figure 9.1.

Provisions need to be made for grouping animals according to age, production, and lactation status. If out-of-season breeding is done, separate air space



Photo 9.3 Loafing area.



Photo 9.4 Scrape alley.



Photo 9.5 Feed access alley.

is needed to segregate animals and control lighting. An access alley on the back side of the barn can provide the flexibility of removing animals by group for milking, going to pasture, etc. Pole barns are generally built with metal roofing and vertical boarding nailed to horizontal purlins. The cost of a pole barn is about \$15 per square foot; when you include gates, feeding equipment, watering, etc., it comes to a total of \$20–\$25 per square foot.

Milking Facilities

Large numbers of goats are more efficiently milked in a milking parlor. This can be contained within the main barn with a separation wall or in an adjacent building accessible by a door or link. The milking parlor can be a pit type, where the operators stand below the level of the animals, or the goats can walk up a ramp to be elevated in front of the milker.

Elevated parlors can be built with steel in place, or commercial, ready-made units with headlocks can be purchased. Either a single unit or two units installed tail to tail, with an access alley, can be used.

A pit-type parlor is generally made of poured concrete with an animal platform and stalls on each side and room for an operator in the middle. The pit depth should be designed for the operator to have a comfortable reach to the udder for machine attachment. Provisions need to be made for easy hand feeding of grain or mechanical feeding using flex augers from a bulk storage bin.



Photo 9.6 Prefabricated elevated parlor.



Photo 9.7 Pit-type parlor.



Photo 9.8a Milk room equipment arrangement.

In a high-line system, a stainless-steel milk pipeline is mounted over the parlor stalls; a low line has the pipeline below the level of the stalls. In either case, the pipeline empties into a receiver jar located in the parlor pit or milk room, which then pumps the milk to the bulk tank. Small goat parlors can use 1½-inch-diameter pipeline (no longer permitted in cow dairies), which can be obtained at a reasonable price (see Dairy Practices Council Guidelines #59, “Production and Regulation of Quality Dairy Goat Milk,” and #70, “Design, Installation and Cleaning of Small Ruminant Milking Systems”).

Milk Room

The specifications of the milk room are determined by your public health department, but milk rooms must have a minimum of the following:

- concrete floor
- drain with trap
- cleanable walls
- hot water heater
- double-vat wash sink
- hand sink
- milking equipment storage racks
- milk cooling equipment
- proper lighting

State standards must be followed for distances around the bulk tank and provisions for proper clean-



Photo 9.8b

ing. Doors need to be self closing, and windows need screens. The milk room needs to be located for easy milk pickup with bulk tank trucks (see Dairy Practices Guidelines #73, “Layout of Dairy Milk Houses for Small Ruminant Operations,” #90, “On-Farm and Small Scale Dairy Products Processing,” and #100, “Food Safety in Farmstead Cheesemaking.”

REFERENCES

Guidelines can be found at the:

Dairy Practices Council
 19 Titus Court
 Richboro, PA 18954
 WWW.DAIRYPC.ORG
 DAIRYPC@DAIRYPC.ORG
 phone / fax 215-355-5133



CHAPTER 10

Starting a New Milk Processing Facility: Considerations and Costs*

Peter Dixon

Facilities

These are the basic requirements for different types of dairy products. Some of the different functions in the processes of making dairy products for commercial sale must be done in separate rooms to prevent cross contamination of pasteurized milk with raw milk and finished products with packaging materials. The different rooms needed for making a variety of dairy products are outlined below.

- **Raw Milk Cheeses — aged more than 60 days:**
 - Production room
 - Mechanical room
 - Aging and brining room(s)
 - Packaging/shipping room
- **Soft-ripened Cheeses from pasteurized milk, e.g., Camembert, Brie, Muenster, Brick, and Limburger:**
 - Raw milk receiving/storage room
 - Pasteurization/production room
 - Mechanical room
 - Salting/drying room: 80% RH, 60–65°F
 - Aging room: min. 95% RH, 45–55°F
 - Finished product cooler: ambient RH, 34–40°F
 - Packaging/shipping room
- **Fresh Cheeses from pasteurized milk, e.g., Chevre, Cottage, and Ricotta:**
 - Raw milk receiving/storage room
 - Pasteurization/production room
 - Climate controlled draining room; refrigerated for Ricotta
 - Mechanical room
 - Finished product cooler: ambient RH, 34–40°F
 - Packaging/shipping room
- **Fluid and Cultured Milk Products:**
 - Raw milk receiving/storage room
 - Pasteurization/production room
 - Mechanical room
 - Finished product cooler: ambient RH, 34–40°F
 - Packaging/shipping room
- **Ice Cream and Butter:**
 - Raw milk receiving/storage room
 - Pasteurization/production room
 - Mechanical room
 - Finished product cooler: ambient RH, 34–40°F for ice cream mix and butter storage
 - Packaging/shipping room
 - Freezer/hardening room for ice cream

* First published in: 2005 Proceedings for the Great Lakes Dairy Sheep Symposium, pp. 14–22.

Other Considerations

An entry room to the processing room is an excellent idea (see Photo 10.1). It helps to keep the production room clean. The entry room can have many functions, such as a worker changing area, a visitor viewing area, and a store. It should be sized according to the specific needs of the business. A footbath can be placed in the doorway on the production room side. Visitors should not be allowed to come into the processing room unless they put on clean boots or shoe covers.

The mechanical room should be large enough to contain the furnace or boiler, circulator pumps, hot water heater, the electrical panel, an air compressor (if needed), and space for tools and spare parts. If an ice water chiller is being used, there should also be a space for it outside of the processing room, although the boiler room may not be the best choice.

Construction: Key Points (often overlooked)

- concrete knee walls in all rooms for storing milk, processing milk, and aging ripened



Photo 10.1 Cheese anteroom.

cheese so that there is no wood below two feet above the floor;

- Floors sloped correctly to drains to prevent puddles;
- sloped window sills with epoxy paint or marine varnish;
- as little wood as possible in the processing room;
- metal doors;
- sealed concrete, epoxy-coated, aggregate, acrylic or tiled floors;
- fiberglass paneled interior walls;
- covered light fixtures;
- separate washing room and kiln for washing and drying wooden shelving adjacent to cheese aging room;
- cheese cellars and caves are more energy efficient and have higher natural humidity than above-ground cheese aging rooms;
- ventilation fans are needed in the milk processing and storage rooms;
- ventilation in cheese aging rooms should be sufficient to prevent build up of ammonia; for soft-ripened cheeses 98 feet per minute air speed is required.

Equipment

The following list has some options depending on which products are made. For example, a cream separator is not needed unless some products are made from low or high fat milk and a curd mill is used for Cheddar and other English-style cheeses. If the milk processing room is attached to the barn, the milk can be pumped directly to the vat or pasteurizer. A clean-in-place (CIP) stainless steel pipe loop is needed to clean out the delivery line unless the piping can be taken apart and washed by hand. If the processing facility is by itself, the milk can be hauled in cans or in a stainless steel or food grade plastic tank.

- **Raw Milk Cheeses — aged more than 60 days:**
 - Furnace or steam boiler
 - Milk pump and hauling tank or milk cans
 - Stainless steel piping and /or milk hose
 - Vat
 - Cream separator

- Drain table and/or press table
- Hoops and followers for forming wheels and blocks of cheese
- Cheesecloth
- Drain matting
- Milk stirrer and other tools, e.g., curd fork, shovel, squeegee
- Curd harps
- Curd scoop and/or pail
- Curd mill
- Vacuum sealing machine and/or waxing system if rindless cheese is made
- Weights for direct pressing, e.g. water jugs, gym weights
- Cheese press: compressed air or hydraulic or lever-action
- Wooden boards and drying kiln or metal shelving with plastic matting
- Whey removal system: pump, hose, and stock tank or bulk tank
- Hot water kettle for “pasta filata” cheeses

- **Soft-ripened Cheeses made from pasteurized milk:**
 - Furnace or steam boiler
 - Milk pump and hauling tank or milk cans
 - Stainless steel piping and/or milk hose
 - Vat or tubs or basins
 - Vat or HTST pasteurizer
 - Air compressor if using HTST
 - Cooling water system. e.g. ice water chiller
 - Cream separator
 - Drain table
 - Single forms or block forms for forming the wheels and other shapes
 - Cheesecloth
 - Drain matting
 - Milk stirrer
 - Curd harps and/or ladles
 - Curd scoops
 - Whey removal system: pump, hose, and stock tank or bulk tank
 - Hot water kettle for “pasta filata” cheeses



Photo 10.2 Testing curd set in a vat.



Photo 10.3 Curd pressing.

- **Fresh Cheeses made from pasteurized milk:**
 - Furnace or steam boiler
 - Milk pump and hauling tank or milk cans
 - Stainless steel piping and/or milk hose
 - Vat or tubs or basins
 - Vat or HTST pasteurizer
 - Air compressor if using HTST
 - Cooling water system, e.g. ice water chiller
 - Cream separator
 - Drain table
 - Hoops
 - Drain bags or cheesecloth
 - Drain matting
 - Milk stirrer
 - Curd harps and/or ladles
 - Curd scoops
 - Whey removal system: pump, hose, and stock tank or bulk tank²
 - Filling/sealing machine or filling machine and hand sealer or vacuum sealer and hot water dip
 - Hot water kettle for “pasta filata” cheeses and ricotta
- **Fluid and Cultured Milk Products:**
 - Furnace or steam boiler
 - Milk pump and hauling tank or milk cans
 - Stainless steel piping and/or milk hose
 - Vat or HTST pasteurizer
 - Air compressor if using HTST
 - Cooling water system, e.g. ice water chiller
 - Cream separator
 - Homogenizer
 - Plate cooler
 - Surge tank
 - Batch tanks for flavors and standardizing
 - Milk bottling machine and capper
 - Filling/sealing machine or filling machine and hand sealer for cultured products
 - Bottle washer for glass bottles
 - Incubation chamber for cup-style yogurt
- **Ice Cream and Butter:**
 - Furnace or steam boiler
 - Milk pump and hauling tank or milk cans
 - Stainless steel piping and/or milk hose
 - Vat or HTST pasteurizer
 - Air compressor if using HTST
 - Cooling water system, e.g. ice water chiller
 - Cream separator
 - Homogenizer
 - Plate cooler
 - Batch tanks for aging, flavoring and standardizing
 - Butter churn
 - Ice cream freezer
 - Fruit feeder
 - Filling machines
 - Freezer for finished products
- **Other possibilities: These pieces of equipment may or may not be necessary:**
 - Insulated storage tank
 - Refrigerated storage tank (farm bulk tank)
 - Ice water chiller (also known as an ice builder)
 - Centrifugal pump for pumping raw milk and/or whey
 - Positive pressure pump for pumping curd and/or soft cheeses and cultured products
 - Refrigerated delivery truck
 - Freezer delivery truck
 - Jet-recirculation parts washer

Regulations

The “Grade ‘A’ Pasteurized Milk Ordinance” (PMO) is the FDA’s regulation book for the dairy industry, which sets down rules for the production of milk on farms, quality/safety standards for raw milk and milk products, and rules for the processing of milk and for construction of facilities.

Each state has a regulation book that is taken from the PMO. The Vermont Agency of Agriculture, Food and Markets has published a Vermont dairy regulation handbook, which is a simplified version of the PMO. If you are considering starting a milk processing business, it is a very good idea to contact the Dairy Division inspector in your state who will be inspecting you, invite him out and go over your plans together. This way, you will have a very clear idea of the regulations from the beginning.

The Federal Code of Regulations (CFR) contains legal definitions of all dairy products. If a certain product is not listed, there is no legal criteria for how it is made or federal standards for its composition. For example, there are federal composition standards for chocolate milk, low fat yogurt, and Cheddar and Cottage cheeses but there are none for Chevre, Brie, and Leicester cheeses. The CFR also sets down “Good Manufacturing Practices” (GMPs) for food production, which are used as guidelines for personal hygiene and safe food production. These are worth reading to find out where the inspectors are coming from and what they are looking for in terms of a sanitary operation.

The Vermont Cheese Council (www.vtcheese.com) has published a “Code of Best Practice,” which sets down GMPs used in making, aging, and selling cheese. There is also a section on creating a Hazard Analysis and Critical Control Point (HACCP) program for a cheese business. The same concepts are adaptable to businesses making other processed milk products. It is wise to become familiar with HACCP because this is the direction that the milk industry is moving in to produce safer dairy products.

The Dairy Practices Council (www.dairypc.org) publishes “guidelines” concerning issues such as animal housing, parlor construction, vacuum pump installation, waste management, cleaning and sanitation, milk quality, and HACCP systems for the dairy industry.

The interpretation of the PMO varies from state to state. Vermont has a relatively relaxed regulatory climate compared to other states. The days of legal retail sales of bottled raw milk are gone but the inspectors will work with small-scale milk processors to find solutions to burdensome regulations, e.g., innovative vat pasteurizer designs and using wooden shelving for aging cheese.

Listed below are some of the important aspects of the regulations that must be considered for the farmstead milk processor:

- **Construction of milking parlor and milk storage room**

- Smooth, impermeable materials
- Easily cleaned
- Covered floor drains
- Well ventilated
- Separate hand washing sink and towels
- Screens to keep out flies and rodents
- Mandatory monthly milk testing for antibiotics, total bacteria, fat, and somatic cells; results must be posted in the milk room

- **Construction of production, storage and aging facilities**

- Smooth, impermeable materials
- Easily cleaned
- Covered floor drains
- Well ventilated
- Separate hand washing sink in production room and towel dispenser
- Bathroom in the production facility if there are employees other than immediate family members working in the business
- Physically separated raw storage and receiving area if making pasteurized dairy products
- Protocol for board sanitation if using wooden shelving for aging cheese
- Product contact surfaces must be stainless steel or food-grade plastic
- Welds on all milk/product contact surfaces must be “3A”, which means highly polished (expensive to make)
- Coolers and cheese aging rooms do not need drains but the floors must be sloped to the doorways so that they can be cleaned and dried
- Storage tanks that are cleaned in place must have chart temperature recorders to show time/temp of milk storage and cleaning cycle
- Each batch of milk must be tested for antibiotics using a rapid analysis (Penzyme, Snap, Charm) before it is processed; results are posted in plant for official review
- Potable water supply; inspected every six months
- State inspection of facilities every three months
- Plan for whey disposal

- **For the Processor who is purchasing milk from other farms** (Additional requirements to those listed above):
 - Must be bonded or have guaranteed letter of credit
 - Must give farmer 90 days notice prior to terminating milk purchases
 - Is responsible for carrying out mandatory milk testing
 - In the case of transporting milk in a mobile tank, there must be a separate enclosed washing facility with a floor drain and hot and cold water
 - For transporting milk in cans, a separate washing bay is not required
 - Milk handler's license is required for all people in the business who are involved in transporting milk and receiving milk (if farmers deliver their own)

Start Up Costs

The costs of starting a milk processing business vary widely depending on the choice of products, the scale of operations, and design and materials used for construction. A reasonable budget includes the costs of constructing the facility, purchasing equipment and installation, and marketing operations. The facility is either built into an existing building, added onto the existing milk storage room of the barn, or a new building is constructed. A facility producing 20,000 pounds of cheese, which includes all of the necessary rooms, will be 1,000 to 2,000 square feet. In very general terms, the interior work for a milk processing facility of this size will cost around \$50,000. The choice of flooring is the largest single factor in the total cost; acid-resistant brick flooring is around \$17 per square foot. A specialized cheese aging room, such as a concrete cave, will add another \$50,000 to the cost.

Equipment costs have the widest variation. Sometimes used equipment bargains can be found and it may only take \$10,000 to get set up to process milk. On the other hand, the cost of new equipment for making fresh dairy products may be \$100,000. A moderate budget for raw milk cheese making is

\$25,000. In budgeting, installation costs are often overlooked. Estimates are needed for boiler hook ups and stainless steel pipe welding jobs. Table 10.1 includes some of the common costs for milk processing equipment for a farm producing 400–600 liter of milk per day. These can be used to develop a budget.

A budget for marketing operations is needed to ensure that there are funds for labels, packaging and shipping materials, sales, service, product samples, promotion, web site development, etc. (See Table 10.2) These costs typically are estimated at 15–20% of anticipated gross sales during the early years of the business; they may decrease to 8–10% once the business has established a solid reputation.

A few additional considerations will help in developing start up budgets. These include: Shrinkage/waste of product, which is made but not of sufficient quality to sell. Count on 20% during first year and 5% is the normal operating amount and is an achievable goal within 5 years of start up.

Set your prices based on what you need to carry the operation. There should be a 40% profit margin above the production cost, which is what it costs you to get the product ready for sale before sales and distribution costs are factored in. Make high-priced products in limited quantities thereby increasing demand.

The previous “cash flow analysis” was for a sheep cheese business. Adjustments in costs and returns must be made if this is applied to goat and cow milk cheese production as follows:

- cheese yield should be set at 10 pounds milk to 1 pound cheese;
- cheese prices should be the same for hard and soft-ripened goat cheeses but \$15 per pound retail and \$8 per pound wholesale for goat Feta and Chevre;
- prices for cow cheeses should be \$16 retail and \$9 wholesale;
- milk costs should be \$25 per hundred weight (cwt.) for cow and \$40 per cwt. for goat.

The cash flow analysis also assumes that the every 5 pounds of sheep milk and every 10 pounds

Table 10.1
Common costs for milk processing equipment for a farm producing 400–600 liters of milk per day

Equipment	Cost (\$)
1 x 1,200 liter cheese vat w/agitator and curd knives (new)	\$15,000
1 x 50 gal vat pasteurizer (used)	5,500
Pasteurization controls and steam filter	3,500
1 x 7.5 HP (60,000 BTU/hr) steam boiler (new)	8,000
Boiler condensate return system	3,000
1 x brine tank (10 ft long x 3 ft wide, used)	1,500
2 x work tables (6 ft long, \$250 each used)	50022
1 x cheese press and drain table (used)	2,000
1 x centrifugal milk pump and dump station (new)	800
25 x 10 lb cheese hoops (\$215 each, new)	5,375
20 x Camembert cheese block-forms (\$335 each, new)	6,700
240 x cheese Aging racks (stainless steel wire, \$25 each, new)	6,000
50 x 5 lb cheese hoops (\$50 each, new)	2,500
10 x 20 lb cheese hoops (\$150 each, new)	1,500
Ice cream freezer (10 gal batch, new)	20,000
Cream separator (100 gal/hr open bowl, used)	800
Cream separator (200 gal cold, 400 gal hot/hr, closed bowl, used)	9,500
Homogenizer (400 gal/hr)	12,500
Ice water chiller (3 HP)	6,000
Walk-in cooler (6 ft. x 6 ft., with refrigeration, new)	6,000
Walk-in freezer (6 ft x 6 ft, with refrigeration, new)	6,000
Refrigeration and fresh air recovery ventilation system (in a room for aging 20,000 lbs cheese per year)	14,000
Cheese aging boards and posts	4,000
Vacuum sealer and hot water dip tank	9,000

of goat and cow milk will yield 1 pound of cheese, which can be sold. This would be the case in an established cheese making business where 95% of the cheese that is made is sold. However, in the first five years, allowances must be made for “waste,” which is cheese that is of poor quality and cannot be sold. It is better to adjust the yield figure as shown in Table 10.3.

Table 10.3
Actual yield (lbs milk/ lb cheese)

Year	Sheep	Cow/Goat
1	6	12
2	5.75	11.5
3	5.5	11
4	5.25	10.5
5	5	10

REFERENCES

Pasteurized Milk Ordinance

Available websites:

WWW.CFSAN.FDA.GOV/~EAR/PMO03TOC.HTML

WWW.FDA.GOV/FOOD/FOODSAFETY/PRODUCT-SPECIFICINFORMATION/MILKSAFETY/NATIONALCONFERENCEONINTERSTATEMILKSHIPMENTSNCIMSMODELDOCUMENTS/PASTEURIZEDMILKORDINANCE2007/DEFAULT.HTM

US Department of Health and Human Services

US Department of Food and Drug Administration

Office of Regulatory Affairs

5600 Fishers Lane

Rockville, MD 20857-0001

888-INFO-FDA (888-463-6332), 302-827-6906

RICHARD.BARNES@FDA.HHS.GOV

Table 10.2
Sample operating cash flow analysis for a sheep cheese business

	Year 1	Year 2	Year 3	Year 4	Year 5
Milk used (lbs)	61,600	100,000	180,600	240,800	301,000
Cheese made (lbs)	12,320	20,000	36,120	48,160	60,200
Yield (lb milk/lb cheese)	5	5	5	5	5
SALES:					
Cheese: (20% retail @ \$20/lb + 80% wholesale @ \$12/lb)	167,552	272,000	491,232	654,976	818,720
EXPENSES:					
Licenses, permits and fees	1,200	1200	1,200	1,200	1,200
Cheese ingredients: (\$2.50/cwt for rennet, salt and cultures)	1,540	2,500	4,515	6,020	7,525
Milk (\$100/cwt)	61,600	100,000	180,600	240,800	301,000
Energy: (oil, electric, and wood)	2,500	4,000	6,000	7,980	10,613
Insurance (liability)	2,500	2500	2,500	2,500	2,500
Loan (\$60,000 @ 5% x 7 years)	5,300	10600	10,600	10,600	10,600
Outside labor (\$12/hr)	12,480	16,598	22,076	29,361	40,000
Marketing (20% of sales): (sales, packaging, shipping distribution, and service)	33,510	54,400	98,246	130,995	163,744
Cheese room supplies: (including cleaning supplies)	500	600	800	1,000	1,200
Office supplies	300	400	600	900	1,200
TOTAL EXPENSES:	\$121,430	\$192,798	\$327,137	\$431,356	\$539,582
Total cost/lb	\$9.86	\$9.64	\$9.06	\$8.96	\$8.96
RETURN TO owner's labor	\$46,122	\$79,202	\$164,095	\$223,620	\$279,138
PROFIT MARGIN before distribution	38%	39%	43%	44%	44%
Cheese production cost/lb before distribution	7.14	6.92	6.34	6.24	6.24

SECTION 4

MILK



CHAPTER 11

Tests for Milk Quality

Daniel L. Scruton

High-quality dairy products have given the Vermont name a marketing edge throughout the country, but that reputation has to be earned every day. Quality needs to be foremost for any dairy goat operation. The basic principles of good hygiene are the same regardless of whether you are milking cows, sheep, goats, or any other type of livestock. It is now legal in Vermont to sell from 50 quarts to 40 gallons of unprocessed raw milk per day under specific regulations but higher amounts require being licensed and pasteurizing the milk. Even with the best hygiene, the consumption of raw milk is not recommended by some because milk is such an

excellent food (bacteria love it, too) that it can easily become a carrier of diseases that are sometimes life threatening. Whatever the end milk product, there is practical information and proven ways to monitor and control raw milk quality.

Somatic Cell Count

The overall udder health in a herd is indicated by the somatic cell count (SCC), also commonly referred to as a leukocyte count. The SCC is predominantly composed of white blood cells and is considered a good indicator of udder health in a herd or flock. A cow with an SCC of over 300,000 cells per milliliter will generally have a bacterial infection associated with the elevation. This is not always true with goats. Other factors may influence SCC in goats.

One factor is that goats have an apocrine mammary. This is a difference from cows because epithelial cells are shed as part of the milk production process in the mammary gland. These shed cells can be confused with SCC if a special staining process is not used when the count is determined. The special stain is required by regulation on all high counts that are to be used for official purposes. More significant than the normal apocrine process is a temporary lactational response (during estrus, for example), whereby a goat may have a count of over 1,000,000



Photo 11.1 Milking parlor.

cells per milliliter that is not caused by a bacterial agent or infection. This normal but sizeable lactational response in goats is why a higher legal limit of SCC is allowed for goats than for cows.

These differences are recognized nationally. The national SCC limit for cows' milk is at 750,000 cells per milliliter, the limit for goats' milk is now 1,500,000 cells per milliliter. The nonmastitis elevation (i.e. lactational response is associated with does in heat and late lactation has been well documented. If a herd tries to make milk for year-round production but has a predominantly fall breeding schedule, there is a high likelihood that the herd SCC will be over 1,000,000 per milliliter from breeding season until dry-off. This is because most of the goats will be breeding and this will cause multiple goats to have a nonmastitis SCC elevation (See Chapter 14 on Out-of-Season Breeding.). The SCC of your herd should for the rest of the year be under 350,000 per milliliter. Remember that from breeding season until end of lactation this level of SCC may not be practical if your whole herd is seasonally bred at the same time.



Photo 11.2 100-gallon ice bank bulk tank.

Other than heat (estrus)-related problems, mastitis also causes high SCC. Prevention is the key to mastitis control. Treating your way out of a mastitis problem is a temporary solution; measures must be taken to make sure new cases are kept to a minimum, or you will be back in trouble soon. You need to identify what is causing the mastitis problem. If possible, think back to when the high SCC or clinical mastitis started and identify any changes that occurred around that time. Below are tests that will supply information to pinpoint sanitation and goat health issues. Results from these tests will help you, your veterinarian and state specialists to develop a program to deal with the mastitis and equipment problems you have and prevent future problems. (For more information, go to www.vermontagriculture.com and search for SCC).

Bacterial Counts

Bacterial counts are done in a number of ways for different purposes. In all cases milk is precisely measured and plated on a growth medium that can predict the number of viable bacteria in the milk. The most common bacteria count in milk is the Standard Plate Count (SPC). This is the total bacteria count for milk that has been sampled at the farm bulk tank, refrigerated, and transported to the lab. This is a good indicator of the sanitation conditions that the milk was produced under and part of the official record that the state uses.

The SPC should be under 5,000 colony-forming units (cfu) per milliliter (ml), with a legal limit of 100,000 cfu/ml.



Photo 11.3 Bacteria culture plate.

Other Common Bacteria Counts

Preliminary Incubation (PI) Count

The PI count is a bacteria count taken of milk that has been warmed and held for 18 hours to simulate what would happen as the milk ages while the product is being made. This test is specific for bacteria that like the temperature range around 50°F. When the PI count is elevated, there is generally a problem with dirty milking equipment, lack of sanitizing the milk equipment, or lack of good disinfection of the goats' teats before milking. For more information refer to the Dairy Practices Council Guidelines (in Appendix 1 at the end of this book).

The PI should remain below 25,000 to 50,000 cfu/ml; the recommended maximum level is 100,000 cfu/ml.



Photo 11.4 Clean and healthy teat end.

Laboratory Pasteurized (LP) Count

The LP is a bacteria count taken of milk that has been heated to 145°F for 30 minutes (or an equivalent approved time and temperature). This is the time and temperature that is used for pasteurization. This test simulates the conditions of pasteurization to see what organisms, if any, would survive it. The most prevalent will be spore formers, and the most common cause is equipment that is dirty in places the milk does not routinely touch (top of bulk tank, vacuum line going to the sanitary trap from the receiver, or other area that milk only occasion-



Photo 11.5 Vacuum system.

ally contacts). Air leaks into the milking system are the second most common cause, especially air leaks in a stable area.

The LP should be below 500 cfu/ml; the recommended maximum allowable level is 2,500 cfu/ml.

Regulatory Enforcement of Counts

When a farm's SCC or SPC count is above the limit for two out of the previous four months, a warning letter is sent out by the state. This letter will warn the farm that if the problem is not corrected, the milk will be excluded from the market. The milk can be sold again after the problem causing the high count has been corrected. For a period of time after the correction has been made, milk must be sampled more often to make sure the problem has been solved.

Other Raw Milk Tests

A number of other tests are run on milk, including tests for antibiotic residues. For a complete list of raw milk tests, refer to the guidelines of the Dairy Practices Council. There are guidelines for the tests as well as for troubleshooting problems. The guidelines have been through a national peer review process. You can order individual titles or the Small Ruminant Set, which is particularly useful for people considering a farmstead cheese milking operation.



Guide to Crisis Management of Somatic Cell Counts in Goats

Daniel L. Scruton

Somatic cell count (SCC) is commonly referred to as a leucocyte count. The SCC is predominantly composed of white blood cells and is considered a good indicator of udder health in a herd or flock. A cow with an SCC over 300,000 cells per ml. will generally have a bacterial infection associated with the elevation. This is not always true with goats. Other factors may influence SCC in goats; (1) the shedding of epithelial cells and (2) a lactational response whereby a goat may have a count over 1,000,000 cells per ml. and not have a bacterial agent causing the count. The extraneous cell issue is addressed using a special stain for goats that is different from the stain used for cows. The second issue of a non-infection SCC is addressed with the higher legal limit used for goats. Sheep, while exhibiting a minor lactational affect similar to one in cows, do not have a problem remaining below the legal limit. This document attempts to point out the major areas of mastitis prevention.

Regulations

The legal limit for SCC in grade A milk is 750,000 cells per milliliter. for cows, water buffaloes and sheep, and 1,500,000 cells per ml. for goats. At least once per month the milk from each producer is sampled for quality evaluation. When producers

are in violation twice in their last four tests they are sent a letter by the Dairy Section of the Vermont Agency of Agriculture, Food and Markets. This letter is a warning that if the next count exceeds the limit the milk will be excluded from the market and the producer will not be allowed to ship milk again until the problem causing the high count has been solved, and the count is below the legal limit.

Preventing Mastitis

Prevention is the key to mastitis control. Treating your way out of a mastitis problem is a temporary solution and measures need to be taken to make sure new cases are minimized or you will be back in trouble soon. You need to identify what is causing the mastitis problem. If possible think back to when the high SCC or clinical mastitis started and identify changes that occurred at about that time. Below are the steps that need to be followed to minimize new cases of mastitis and develop a program to deal with the mastitis you have and prevent future problems.

Milking Procedures

Proper milking procedures are essential to minimizing the risk of a bacterial infection that could cause mastitis. At the end of this chapter is an outline of a



Photo 12.1 Goat udder.

good milking procedure. It also elaborates the procedure and explains why steps are done in the order given. Feel free to copy these pages and post them in your milking area. The goal is to milk clean, dry, sanitized teats. Be sure that you examine the teat ends as well as the sides of the teats after they have been prepped, to determine that the ends are clean. Make sure the teat dip you are using is effective as shown by protocols recommended by the National Mastitis Council. Your route supplier should be able to show you the results of the study in which the dip you're buying was tested according to those protocols, usually performed by a University. Dips that have not been tested against those protocols may be effective, but without the independent verification the protocols provide, they are an added risk. Eliminating unknowns is especially important if you are having problems.

After an exclusion (when milk produced on a farm is not allowed to be sold because of repeated tests with high SCC) there is a temporary reinstatement followed by accelerated sampling period where four samples will be taken in a 21-day period with no more than one per day or two in any week.

If any of these are high, you will again be excluded until the count is consistently below the legal limits.

Clean, dry, well-nourished, and comfortable dairy animals are less likely to develop problems from mastitis and many other disease problems. Bacteria need moisture, warmth, and nutrients to multiply, and, while all of these are present in a dairy barn, measures can be taken to minimize them. Some bacteria will double every 20 minutes under the right conditions. Have the nutritive value of your forages analyzed and get a nutritionist to review the adequacy of your doe's dry and lactating rations, including micronutrients such as vitamin E, selenium, zinc, and copper. Dry-matter calculations should be performed on feed at a variety of times through the season to make sure the proper amounts are being fed. Udders should be clipped to minimize the risk of hair interfering with the sanitizing and milking processes.



Photo 12.2 Goats on bedded pack.

Goats do not typically use stall barns, but are housed on bedded packs. This is much more feasible for small ruminants, as their manure is much dryer than cows' manure. However, regular cleaning and bedding of the barn is still needed, and overcrowding can be a major problem. The principle of clean, dry, and comfortable still applies. The pack needs regular attention; bedding should be added daily and grooming performed to minimize areas where animals may get dirty.

Feeding areas should be in a different area than the packs, when practical. It is best for the animals to walk some distance from the feeding area to the pack, as most of the manure will be in the feeding area and can be scraped out daily. Water fountains should also be off the pack. Free stalls are being investigated as a dryer and more comfortable alternative, but not enough data is available to make specific recommendations.

Milking System

Two or more times every day, your milking system harvests the crop that pays your livelihood. It is essential that the system be in good working order. It needs to provide stable vacuuming, adequate pulsation, and gentle milking action. Have your milking machine dealer test your system every 1,200 hours of operation, or annually, whichever is shorter.

Claws should have adequate capacity for efficient throughput of the milk or be designed not to need capacity (quarter milkers, etc.). If clawless milking is used, the milk hose from the inflation to the milk fork should be at least 3 feet long, or provide special pulsation, like a periodic air inlet.

Milking systems for goats should run at about 10 to 12 inches of claw (or milk tube) vacuum and may use considerably more units per slope than for systems for cows do. For more detailed information on small ruminant milking systems, refer to the Dairy Practices Council Guideline #70 (WWW.DAIRYPC.ORG).



Photo 12.3 Milking claw.

Depending on design, slope, and milk flow rates, goats should use approximately the following lengths of line:

- 1.5 inches line 3–5 units per slope
- 2 inches line 6–12 units per slope
- 2.5 inches line 12–18 units per slope

Pulsation is also different than on cows. Sheep and goats store milk in their gland cistern more than in the milk producing sacs (gland) in the udder. This, along with smaller teat size, makes a faster pulsation acceptable. For goats typical pulsation would be from 60 to 90 pulsations per minute (PPM). *Caution: Speeding a pulsator designed to run at 60 PPM to 120 PPM may not give adequate rest phases or adequate milk phases.* It is best to use a pulsator designed to run at those higher speeds or have a dealer graph the pulsator in question to make sure it is functionally adequate. Inflatons need to be sized for the herd involved. Some goat herds are successfully using cow inflatons; however, as the herd's genetics are improved, a larger percent of the animals will have a consistently sized teat and may need to use a liner designed for goats. Talk with your equipment supplier about the options available.

Prudent Treatment Plan

A treatment plan for mastitis should be developed with your veterinarian before problems start. It should include the following:

- what to do when specific problems occur;
- who will do the treatment;
- what records and withholding procedures will be used;
- a dry animal therapy program.

Culling

Cull those animals that repeatedly have mastitis problems. At times high SCC problems are from a poor culling and treatment plan more than from new infections. If high SCC animals are not culled, the percentage of high SCC animals increases, as does bulk tank SCC, as new infections occur. A rule

of thumb to judge your mastitis program is that you should not be treating more than 1% of your animals for mastitis in any one month, and only half of those should be new cases. If you are treating more than that, you should contact your veterinarian and investigate why you have such a high infection rate.

Records

Good records are important in the long-term strategy to maintain low SCC. Keep accurate records of all treatments, including which half what medicines were used, and the date. Production records and other animal health records are also important for any herd breeding plans and culling decisions. They records can help identify trends that can be corrected through management.

SCC Crisis Management

To rapidly reduce your bulk tank somatic cell count, you must first identify the problem animals and then culture and treat them or cull them, as described in the following paragraphs.

Identify Problem Animals

There are a number of ways to identify animals that are causing a high somatic cell count:

1. One way is to contact DHIA (Vermont office, 800-639-8067) and join a testing program that will regularly determine SCC and milk production information. DHIA has a variety of programs available; and if you are not currently receiving SCC information from them, they will give you one month free.
2. Another alternative is to have your milk handler measure SCC your individual animals. This option will depend on the milk handler involved. Contact your milk handler field rep to see if his or her lab can handle the number of samples involved.
3. An alternative that can be done right at the farm is to use the California Mastitis Test (CMT). CMTs have the advantage of providing results for individual halves; however, it is commonly misused, and if the test is not properly done,



Photo 12.4 CMT paddle test.

high-SCC animals may be missed. CMT kits are available from most dairy suppliers and come with a set of instructions. The most common mistake is to use too much milk and/or reagent. A few streams of foremilk (sampled before milking the animal) are stripped out. Then a small amount of milk is put into the paddle. The paddle is tilted almost vertically, so that only 1–2 teaspoons of milk remain in each cup. An *equal amount of reagent* is added to the milk and swirled for about 15 seconds. The paddle is then tipped back and forth to see if any thickening of the milk occurs. The more the thickening is, the higher the SCC. Any trace amount of gelling on the paddle indicates an SCC of around 300,000 per milliliter; a thickening of the milk, but not clumping together, indicates around 500,000 to 1,000,000. If the milk thickens and clumps together, SCC is over 1,000,000. If it thickens and sticks to the paddle, the count is generally over 2,000,000. If you are unsure of the results, your inspector, most field reps, and veterinarians have done CMTs and can help. *NOTE: CMTs must be read under a good bright light, and the reagent needs to be stored properly. Follow label directions for storage.*

Culture and Treat or Cull

With goats you will want to identify the high-SCC animals, but whether or not treatment is appropriate will depend on the animal's stage of lactation. Uninfected, late-lactation animals with high SCCs may need to be dried off if they are causing the tank to be over the 1,000,000 limit. Work with your veterinarian to develop a treatment plan for the



Photo 12.5 Flow valve.

high-SCC animals when it is appropriate. Your veterinarian may want to culture some or all of those animals. Work with him or her and make decisions on each animal as to the economics of treating or culling. About three weeks after an animal has been treated, do an SCC test and consult your veterinarian to see whether a culture or repeat treating is needed. *Remember: Do not treat based just on SCC results; work closely with your veterinarian to ensure that you are properly handling the animal treatment decisions, and keep good records.*

Summary

In summary, the key to long-term low somatic cell counts is prevention, and that can be summarized in five points:

1. Use proper milking procedures and make sure your animals are clean, dry, well nourished, and comfortable.
2. Keep your milking system well maintained and operating properly.
3. Work with your veterinarian to have a good treatment plan on hand.
4. Cull chronic offenders.
5. Keep good records of animal history and treatment.

If you already have a problem, develop a team approach to solve it. Work with your veterinarian, your milk handler field rep, the Vermont state dairy inspector, UVM Extension, DHIA, the Vermont

Agency of Agriculture's Milk Quality Enhancement Program, or others (in your respective states) as needed to develop a cohesive strategy to resolve the problem in the short term and prevent it from recurring. In Vermont, for help with long-term prevention, you can contact Laurel Junkins, Dairy Systems Coordinator, at 802-793-3868 or LAUREL.JUNKINS@STATE.VT.US.

On page 79 is a further explanation of the milking procedure listed below. Please post this in the milk-house or milking parlor for review by personnel as needed

Animals should be maintained in a clean, dry environment 24 hours a day.

When predipping, it is very important to cover the entire teat. It is difficult to consistently cover the entire teat when spraying. Spraying in a tie stall barn is not recommended.

If teats are heavily soiled, wash them each with an individual paper towel dipped in an udder wash solution that's compatible with your predip.

If you are in Vermont, for further explanation or for assistance with your milk quality problems, please contact Laurel Junkins at the Milk Quality Enhancement Program, 802-793-3868 or LAUREL.JUNKINS@STATE.VT.US.

This article adapted from *Guide to Crisis Management of Somatic Cell Counts in Goats*, Vermont Agency of Agriculture, Food and Markets, Second Edition. Now also available from Dairy Practices Council.

Recommended Milking Procedure

1. Completely dip each teat.
2. Observe the foremilk.
3. Wipe dry with individual towel.
4. Attach unit.
5. Keep unit adjusted.
6. Shut off vacuum, then remove unit.
7. Dip teats.

Further Explanation of the Milking Procedure

1. Completely dip each teat. Use a product that is labeled as a predip and has been shown to be effective at preventing mastitis. *Be sure to cover the entire teat* and allow for at least 30 seconds of contact time.
2. Strip out in a strip cup and observe the foremilk from each teat for abnormalities. This stimulates letdown, checks for mastitis and sanitizes your hands (with the dip solution). *Do not strip milk into your hand.*
3. Dry each teat thoroughly with an individual paper towel, removing all the teat dip to prevent any residue. If the predip has dried, redip the teat and remove the predip while it is wet. Do not touch the teats after removing the dip.
4. Attach the milker unit within one minute after the start of stimulation. *Do not attach it to blind halves as they these halves may contaminate the milk and spread mastitis to other animals.*
5. Adjust the unit as necessary for proper alignment to prevent “squawks,” especially at the end of milking, when the slightest “squawk” may increase the risk of new cases of mastitis.
6. Shut off the vacuum before removing the unit.
7. Dip teats immediately after unit removal with a product that has been shown to be effective at preventing new cases of mastitis. *(See below verification statement from NMC.)

Discard used dip and wash the dip container after each milking.

Caution: In freezing weather dip should be removed from the teat or allowed to dry on the teat before the animals are turned out.

* Efficacy, ability to prevent mastitis, can be shown through research protocols recommended by the National Mastitis Council. The dips are tested under either experimental challenge or natural conditions.

SECTION 5

BREEDING

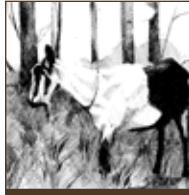

CHAPTER 13

Out-of-Season Breeding

Daniel L. Scruton and Jordan Le Roux

Goats are naturally seasonal breeders and go into heat (estrus) in the fall to breed and have their kids in the early spring. Their estrous activity correlates with the seasonal change of decreasing daylight. In nature, this action is caused by the need to give the kids the best chance for survival. Given the approximate five months of gestation, they must be bred in the fall to give birth in the spring. The shortening days in the fall signal the goat that it is time to breed. To have does freshen throughout the year one needs to create an artificial environment in which the days seem to be getting shorter.

A producer that wants a steady supply of fresh milk must breed a portion of the herd out of season. Out-of-season breeding can also be helpful since only that portion of the herd will contribute to a spike in SCC that is caused by being in heat. The SCC spike is explained from the cytokine (immune system regulator molecule) release that occurs during estrus which causes rapid deployment of white blood cells into the milk. On many goats this reaction is lower during spring breeding. The cytokine that triggers this deployment is a different cytokine than the one that is released when a potential mastitis-causing organism enters the doe's gland. The release of the cytokine during breeding season is why it is difficult to maintain an SCC below

1,000,000 cells per milliliter from breeding until dry-off if all the goats are in heat. Plus, in a large number of goats the SCC does not go back down after the doe is bred in the fall. This specific elevation in SCC is only after heat, so if a spring kidding herd has an average SCC over 300,000 in the spring and summer, there is probably a mastitis or milking equipment problem that needs to be addressed. For all dairy goat herds it is very important to stay ahead of any SCC problems. For more information on SCC in goats, refer to Chapter 12, "Guide to Crisis Management of Somatic Cell Counts in Goats."

One other word of caution: Anecdotal evidence suggests that mixing goats that are in heat (where bucks are in rutt as well) in a herd with goats that are not in heat may cause those not in heat to have some of the hormonal reactions that the does in heat have. Most important, the SCC may go up significantly. Housing facilities should be designed such that herds that kid in the fall and those that kid in the spring have separate areas, preferably in a different wing of the barn, so that the odors given off during heat do not reach the non-heat group.

Producers should develop a reproductive management strategy for their herd. One strategy that has been used successfully is to cycle all of the first kidders through the protocol explained in this

guideline, as the first kidders seem easiest to breed out of season. In subsequent years, the does that bred out of season successfully and the next crop of first kidders would be cycled through the light protocol. This should give a high enough success rate to provide a fairly consistent milk supply. Does that are bred to kid in the fall sell at a premium, so there are also economic benefits to having a successful spring breeding program beyond the constant milk supply.

An additional benefit of a successful spring breeding program is that the processing plants that purchase goat milk for fresh cheese and fluid products will often pay a premium for milk produced in the winter months, when goats are normally producing low or no volume of milk.

Protocol for Yearlings

1. Subtract nine months from when you would like the does to kid in order to determine when the goats should start the protocol. Refer to Figure 13.1 for an overview.
2. For two weeks prior to the light treatment, feed a higher energy ration to the goats.
3. Schedule the light treatment to begin 135 days before the desired time to breed the doe.
4. The does and the bucks need to be exposed to a minimum of 20 foot candles (215 lux) of light for 16 hours per day for 75 days. For spring breeding, the “long day” period would start in mid-December. Goats are more receptive to the daylight if kept close to what a normal day would be in the summer months. Therefore, it is recommended to have the lights on surrounding this period of actual natural daylight: Provide three hours of artificial light in the AM before the sun rises and three hours after the sun sets. You could keep the lights on a timer and run them continuously from the AM hour to the PM hour; or the lights could run with an outdoor light sensor that would turn the lights off (or reduce the number of lights) when the sun comes up, provided gates and sidewall curtains are opened to encourage the goats out into the daylight.
5. The bucks can be allowed to stay in the pen with the does during the 75 days of treatment, or they may be in a separate pen with the same light treatment. (A minimum of 1 buck for every 15 does is recommended; if you do not have enough bucks, it is better to breed does individually.) After the 75-day light treatment, the bucks should be removed from the does if in a common pen. The bucks and does should not be able to see, or smell, each other for the next 60 days. This is done to further stimulate the bucks when it is time to settle the does. *Caution: Bucks can become possessive and dangerous—care should be taken when working in a pen with bucks.*
6. After 60 days of separation, the bucks are reintroduced to the does. At this point, he really needs to be in the pen with them at all times and not in a pen next door. The does may come into heat as early as one week. Typically, once several does start to come into heat, others will follow. Early heats are difficult to detect. Heats will last 5–15 days. In the first 6–8 days, 70% of the heats will be silent, while the other 30% will be visible. After 6–8 days, most of the heats should be detectable.
7. Does that did not settle should be either culled or kept until the more natural time to breed,

provided gates and sidewall curtains are opened to encourage the goats out into the daylight.

The other eight hours should be an uninterrupted dark period. Automatic sidewall curtains could serve as “black-out” shades, provided the curtains are dark colored, not opaque. For best results, it is recommended to obscure the light at the end of the treatment. Research has shown that does are more receptive when light is followed by complete darkness.

Care also needs to be taken to make sure the goats have adequate ventilation. During the dark period this could be done with fans, provided there is an air plenum that is dark colored to allow little light infiltration during the dark cycle.

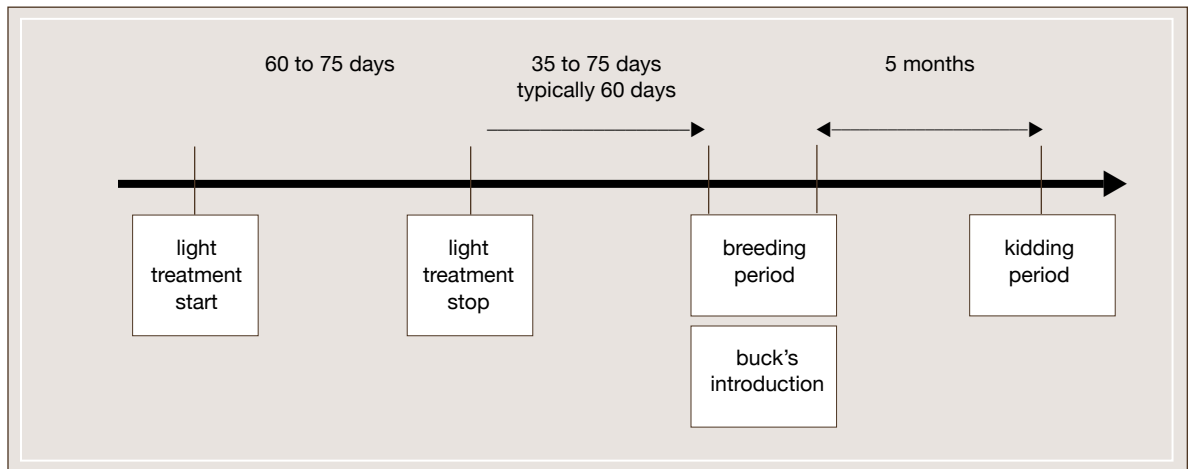

Figure 13.1 Typical out of season cycle.

in the fall. Most does that did not breed in the spring will breed in the fall. Does that do not breed after a spring and a fall attempt should be culled.

Second and Later-Lactation Does and Larger Herds

First kidders generally cycle out of season more successfully than older animals. Animals that settled out of season on their first lactation will be easier to breed out of season on subsequent lactations. A well-designed barn for year-round production of milk from goats will have the fall and spring kidding herds in separate spaces. This helps in two ways: The entire out of season group can have supplemental light added for 75 days and cycled, and those in heat will not be sharing space with those not in heat.

If the area for the spring-freshening herd is separate, use the same protocol shown for first kidding goats. You will want to start a few weeks earlier or later than you start the first kidders to spread out the arrival of the kids. On very large herds there may be several groups of animals being cycled, and they can have a variety of start times to spread out the milk and the kids.

Producers of large herds will want to stagger the light treatments and have multiple light treatment pens if they want to space out the kidding season.

Facility Needs

The needed lighting intensity suggested is 20 foot candles (215 lux) at the goats' eye level. The new-style T8 (1-inch-diameter) fluorescent tubes put out about 2,850 lumens each. If you assume a 10-foot ceiling with light-colored walls and an average goat size of 3 feet tall to eye level, you should install a light fixture for about every 150 square feet. In a stable, the fixture should be dust, corrosion, and moisture resistant to meet the requirements of the National Electrical Code. Sealed fixtures are much easier to clean and will last longer in a barn environment. For lights other than T8 fluorescents, the electrical supply house should be able to do the calculation. One conversion is that a 32-watt T8 4-foot lamp produces about the same output as a 40-watt T12 (1½) old-style fluorescent lamp.

Fluorescent bulbs, or other light sources, must be put in the pen where the goats are and not in the aisle. For evenness of light, the height of the fixture above the animal should be half the width of the pen. For wide pens, lights need to be spaced to give even light. The electrician should space the lights so that the zone of influence of the light is about double the height of the light fixture above the animal.

So, a pen 16 feet wide would need a light down the center of the pen if a two-tube T8 fluorescent fixture four feet long is used you would space them four feet apart or use continuous single tube fixtures.

In Summary

In order to successfully produce milk out of season, it is recommended that you have two herds and treat them separately. Goats are susceptible to creating a chain reaction, and, as mentioned, when some goats are in heat, others will come into heat. Goats in heat act differently. They are excitable. They eat less, their production can be less than expected, and their somatic cell count may go up.

Goats are not machines. A good plan does not guarantee 100% success. However, kids that are born in the fall are good candidates for out-of-season breeding.

If the protocol is strictly followed, there is no difference in conception rate between goats that freshen in the spring and goats that freshen in the fall.



The Impact of Genetic Selection

Carol Delaney

Any trait you want to change or select for needs to be measured and recorded somehow. You can make up your own evaluation system or borrow recommended measurements but it needs to contain strong elements of objectivity and consistency. If milk yield and days in milk are important to you, their performances in the first year of lactation are very good indicators for future performance. Thus, you can base your selection of replacements on the yearlings' lactation performances.

Ease of kidding (Photo 14.1) is a worthy trait to track for its effect on economics (costs of labor, vet intervention, medical supplies, etc.) and production (time lost to recovery and uncaptured peak production potential).

The obvious genetic traits that researchers and farmers have focused on are milk production and yield of protein and fat since these directly determine income for fluid milk and cheese yield for farmstead cheese makers. However, if you select goats for higher milk production only and ignore personality and body traits, your herd may become malformed in relation to the milk yield. In the 1990s in France they emphasized high milk production in goats for a decade and they had to weed out the many goats with bad udders. It is best to consider soundness traits as well as production traits so as

not to compromise the goats' ability to do well in the environment provided to them.

One milking trait of goats that has high heritability (65%) is the speed of milking. (For background, the degree of heritability roughly means how much of the trait, based on 100%, directly comes from the genes of the goat with the remaining difference in percentage coming from the influence of the environment.) Thus, if you have a very high producer but she is a slow milker, that adds milking time and you risk over-milking the other goats waiting for her to finish. It would be prudent to avoid retaining replacement does from her offspring because the heritability of the trait is so high.

Milk and protein yield have heritabilities of about 30–40% so their improvement can be made more gradually by measuring an individual goat's milk content and doing a comparison among the does. It is more difficult to increase the solid content (fat, protein, etc.) of milk while choosing for increased milk production because milk amount is inversely related to the percent of milk fat and protein in the milk.

Sometimes there is a question about selecting offspring from animals with high somatic cell counts (SCC). SCC is not a trait that can be selected for or against based on the actual milk measurement.



Photo 14.1 Good kidding and mothering traits demonstrated.

However, an animal with consistently high SCC due to recurring or chronic mammary infections should be culled to prevent infecting other animals. Mastitis can most easily begin and spread in the milking parlor (machines or protocol), a high risk area for infection because the teat ends are opened. The second area where infection can occur is in the bedded area especially if the does lie down on dirty bedding soon after milking. At Langston University, a mastitis rate of 5% is considered acceptable for a commercial herd (at any one time, 5% of milkers exhibit mastitis).

For an example of a selection program for a goat herd, we can look north of the border to research done recently in Canada¹. In Québec and Ontario, starting in 2001, they enlisted 26 herds of goats where farmers followed selection protocol-based traits that were balanced to 60% production and 40% conformation. The production traits were as follows:

- milk, protein, fat yield;
- fat and protein percent;

The conformation traits of general appearance are:

- leg strength;
- dairy character;
- body capacity;
- median suspensory ligament;
- front and rear attachment of the udder;
- teat quality.

These traits were combined into a “selection index.” Genetic progress is often faster using a selection index rather than looking at each trait individually.

They made their selection of the young based on the performance of their dams and related females. Scientifically, the desired system of genetic improvement is to select different male offspring from the best goats in various herds and then breed them to many herds (using artificial insemination). These bucks are then ranked based upon the performance of their respective daughters’ many herds. This is done in the United States for bulls of dairy breeds and you can get very detailed information on proven bulls, including how well they improve a certain trait like milk yield. Some of this is done for dairy goats, too, and genetic improvement in herds can be rapid using semen from proven animals. However, because this work requires lots of records of daughters and takes years to get data from a couple of lactations because there are not many proven bucks in the U.S. In Canada, they knew this would take a lot of time for dairy goats so they focused instead on selecting the offspring of known superior animals in each herd that had been evaluated.

After 4 years of continued selection on these 26 dairy goat farms, they published the results for the Saanans and Alpines in the study. They found that the average annual production improvement over the 4 years was between 15.5–18 kilograms of milk (34.1–39.6 pounds) per goat with an annual average increase of .32–.52 kilograms (0.7–1.14 pounds) butterfat and .33–.47 kilograms (0.7–1.0 pounds) milk protein per goat. This progress, they estimated, gave an increased return of \$1400–\$1600 per year per farm, minimum. And this rate of annual improvement superseded that found in the U.S. and France in the previous 5 and 10 years.

In the United States, the American Dairy Goat Association is a good resource for finding goats critically subjected to type or physical evaluation (linear appraisal) and milk production and content measurement. Records of many animals and their pedigree (shared relatives) can be analyzed and the predicted transmitting ability (PTA) is ranked based on or their type and milk production (Production Type Index). Basically, this means you are able to find animals that have been found to improve physical traits and milk production and content based on actual records. This can be found on the internet at WWW.ADGA.ORG.

Another point to make is that annual progress is affected by the replacement rate you choose to follow. It is like investing money at different rates of interest. The higher the interest rate, the higher the compounded return over time. For example, if you decide that you will selectively replace 10% of your goats per year with your best replacements you will see only 25% of the improvement than if you chose to replace 40% of your goats with better replacements over a period of 10 years. If you practice a higher replacement rate, the genetics in your herd will become more concentrated or similar so you will eventually want to look for new genetics to inject into your herd to prevent higher degrees of inbreeding. As animals become more inbred, their milk production tends to drop in comparison to their genetic potential.

Inbreeding is caused by mating individuals with the same ancestors. Some purebred breeders do employ line breeding to specifically concentrate the genes of an extraordinary individual in new generations. They keep detailed milk production records and have their animals subjected to linear appraisal by a third party. For goats registered in the American Dairy Goat Association, for example, the inbreeding coefficient is supplied by the pedigree service. Watching for defects, these breeders can see up to 20% concentration of the same ancestor's genes in offspring. However, unlike line breeding, inbreeding is more common when breeders do not intentionally mate animals with similar ancestry. It is recommended to limit the inbreeding to no more than 10% in any one individual.² In general, for

every 1% increase in inbreeding above 10%, there is a 1% decrease in production traits.

Genetic selection of your animals based on measured traits that fit your management system will result in progress toward your goals. The rate of progress will depend upon:

1. *the intensity of selection (e.g., replacement rate per year 5, 10, 20, 40%?) and the number of traits you select for and your emphasis on each trait.* The more traits included will slow the progress but has the potential to create more balanced animals in physical and production traits;
2. *the ability to accurately measure the traits.* (What traits have you observed in a goat that lives the longest, is the healthiest and produces what you want? How is this measured?) The great advantage of DHIA testing is that it can usually do a better job than you at identifying how much of the difference of milk yield in your does is due to genetics versus their environment;
3. *the variability of the trait in your herd.* (Do you have a wide range of low producers and high producers to choose from? If not, you can't improve much unless you import other genetics by buying breeding stock or using AI;)
4. *the interval of a generation.* (i.e. the average age of the parents at the first birth of their descendants. Are you breeding before one year of age or waiting another year?)

Once you decide what measurements to make on which traits, your annual replacement rate will determine how quickly you make progress.

ENDNOTES

1. Colloque sur la chevre 2005, L'innovation, un outil de croissance! L'impact de la génétique sur les entreprises caprines. Laurence Maignel, pp. 28–34. WWW.AGRIRESEAU.QC.CA/CAPRINS/DOCUMENTS/GINGRAS_SOPHIE.PDF
2. Proceedings of the National Goat Conference, Breeding for Improved Dairy Goat Production: A Genetic Toolbox, pp. 14–31 and presentation, Dr. Terry Gibson, Langston University, September 13, 2010, Tallahassee, Florida.

SECTION 6

FEEDING



CHAPTER 15

General Goat Feeding Behavior and Diet Recommendations

Carol Delaney

Feed costs can comprise over 50% of the expenses on a dairy goat farm and the diets fed can greatly influence the production and health of the herd. Thus, some basic discussion of the unique digestion and eating behavior of goats coupled with a summary of current feeding recommendations and resources for balancing rations will be covered here.

Goat Feeding Characteristics

Goats are in the Bovidae family, which means they are ruminants with a compartmentalized, four-stomach digestive system. This allows them to eat fibrous plants and digest part of the fiber (the fermentable part) and convert it to energy. The rumen microbes have enzymes that can break down fiber and the by-products supply energy to the animal. This happens in the large rumen, a vat-like stomach. The best and cheapest form of energy for the ruminant animal is high quality forage. This is particularly important for goats due to their unique metabolism and thus feed preferences and intake characteristics compared to other herbivores (plant eaters).¹

Unlike cows, which eat with their heads down, use their tongues to grab forage, and often select clover over grasses, goats like to eat leafy plants at

the height of their head and above and feed with their lips; they prefer higher sward heights, will commonly select grasses over clovers, and will eat from the top down, including seed heads. Goats are alpine creatures, used to climbing, and stand on their hind legs to browse leaves in trees. Thus, feeders that allow the goat to place front legs on a step will prevent it from standing in the feed trough and contaminating the feed with manure. Or, construct feeders that prevent the goats from stepping into the feeder in the first place.

In Photo 15.1, the forage manger is simply built with used plastic containers, and the fabrication of slatted bars for goat access prevents much wasting of feed on the floor. The presence of angled bars discourages backward movement of goats away from the manger thus decreasing dropped and wasted feed. Plus, since the goats have to angle their head to get at the feed, there is no incentive to jump on the feeder. This system will also allow an easy way to measure forage intake.

Goats need 25% more energy than sheep for maintenance per pound of flesh. Conveniently, to make up for this higher energy need, goats can eat more than a sheep can per unit of body weight: i.e., goats can eat 3.5–5.5% of body weight in dry matter intake (DMI), whereas sheep (and cows) are closer



Photo15.1 Dairy goats consuming hay in a manger.

to 3–4%. Cows and sheep eat more fiber (cell walls) than a goat can. Goats need more time to chew their forage fiber than cows, because the goat’s jaw is smaller, and a goat needs to reduce the size of the forage by rumination half the size that a cow does.²

When the quality of the feed decreases (to more mature forage and higher levels of nonfermentable fiber), goats will eat less feed and/or they will select the higher-quality parts first. Cows compensate for low quality by being able to eat more. In terms of diet form, goats prefer pellets or textured feed and dislike dusty grain or meals. This seems to be because they can eat and swallow more pellets faster. Goats are able to chew and reduce the size of whole grains or crushed grains yet are very sensitive to molds and spoiled feed and can die quickly of listeria or coliform infection that cows can tolerate more. Well-preserved feed in clean feeders is very important for keeping goats healthy. Goats are sensitive to changes in feed and one feed company mixes in an apple flavor to mask any changes in taste over time during storage to prevent refusal.

Ruminants prefer to eat more than one meal a day and then ruminate, or regurgitate, re-chew, re-salivate and re-swallow. This is important for aiding the breakdown of the fiber *and* to add saliva to the feed. Saliva is an important buffering agent and

will help prevent a rumen from getting too acidic. While a cow likes to eat 2–3 times per day, a *normal eating pattern for goats is 4–6 times per day*. Thus, a goat will eat more if feed is refreshed more than twice per day. She is able to better balance her diet that way and to digest the feed better.

Goats like water that is about 60°–80°F and they will decrease their water intake when water temperature drops below 41°F. In general, *dairy goats will drink 20 pounds of water (2.5 gallons) for every 5 pounds of dry matter intake*.

Diet Considerations

Dry Matter

The concept of dry matter (DM) is essential for understanding diet formulation and using ration balancing programs. It puts all feeds on an equal basis by looking at them without the moisture.

Table 15.1 shows, for example, how much goats would need to eat to get 3 pounds of dry matter from each feed. As-fed means the feed eaten as it is offered made up of DM and moisture.

Table 15.1
Examples of dry matter calculations

Hay	90% DM	3.33 lbs as fed
Pasture	10% DM	30 lbs as fed
Haylage	30% DM	10 lbs as fed

Divide 3 pounds by the feed DM as a decimal, for example,

$$3 \text{ lbs} / 0.90 \text{ DM hay} = 3.33 \text{ lbs as fed}$$

Researchers at the Miner Institute in Chazy, New York, measured dry matter intake (DMI) for Alpines as related to their body weight (BW).³

This is what they observed in their study:

- lactating yearlings are limited to eating about 3.7–4.8% of their body weight;
- lactating mature does can eat about 4.1–5.3% of their body weight;
- a general average of DMI to use for a milking herd is 4.5% of BW.

Another way to estimate DMI is to add DMI based on production to the DMI for maintenance (from 1980 Cornell Nutrition Conference Proceedings). Use Table 15.2 to make these calculations.

Table 15.2
Intake estimates for maintenance and production

Body Weight (lbs)	Dry Matter Intake (lbs/day)	Milk (lbs/day)	Dry Matter Intake (lbs/day)
100	3.0	2	0.0
110	3.1	4	1.0
120	3.2	6	2.0
130	3.3	8	2.9
140	3.3	10	3.8
		12	4.2

Adjust DMI in last 2 months of pregnancy by a decrease of .3 lbs

For the most recent and very specific DMI for each size of goat and production level, refer to the last section of this chapter, Ration Balancing Resources.

As you can see, high-producing dairy goats in early lactation are driven to eat over twice what they normally would as compared to a nonlactating doe. In the Alpine breeds (vs. African), milk production is a better predictor of intake than body weight, but both measurements are important factors.

The farmer can keep records of intake for grain and forages fed to goats, and this would be a better basis of what the goats are able to eat than using estimation tables.

When the quality of forage drops, goats have a tendency to be more selective in order to keep up the level of quality in their diet. If the quality of forage is lower than needed to balance a ration, it has been shown that allowing the goats to refuse or leave 20-50% will allow the goats to keep their diet at the nutrient level they need to sustain production.

Nutrient Feeding Recommendations

Fiber

The suggested fiber level (NDF or neutral detergent fiber) in the whole diet for goats and sheep is

32–40%. An excellent quality forage has an NDF of 30–33% or less.

Drs. Mike Thonney and Doug Hogue of Cornell University suggest that, based on their research with sheep, one needs to supply at least 35% potentially fermentable fiber (pNDF) in the diet. There is a feed formulation tool at the Cornell sheep website:

(WWW.SHEEP.CORNELL.EDU)

WWW.SHEEP.CORNELL.EDU/MANAGEMENT/

ECONOMICS/CSPSOFTWARE/FEEDFORM/INDEX.

HTML

and it incorporates the balancing of pNDF levels.

Starch and Sugars

Studies have shown that dairy goats eat diets with wide ranges of amounts of starch (18–44% in their diet). The more starch is in the diet, the more digestible fiber that must be added to help prevent rumen pH from getting too low and causing acidosis. In general, Vermont feed rations that have about 18–25% starch and sugars have worked the best.

Protein

In free-choice feed studies, lactating dairy goats have shown to balance their diets (forage and concentrate combined on a dry matter basis) to 15.5–16.5% crude protein. This is the most protein in the diet that any goat should be fed. At the lower end of the requirement spectrum, dry goats and inactive bucks only need a diet at 10–12% crude protein.

Milk urea nitrogen (MUN) is an indicator of excess protein or nitrogen in the diet. In goats, MUN measurements are not as well correlated with percent crude protein in the diet as they are in cows and sheep. On pasture, there is a fairly strong ($R^2 = .79$ where R^2 is the correlation coefficient) relationship between MUN levels and crude protein (CP) as a percent of diet DM in goats. Roughly, the formula is as follows:

$$\text{CP as a \% of diet DM} = 7 + [\text{MUN} \times .61]^3$$

MUN can be measured with a bulk tank milk sample sent to a DHIA or Dairy One lab for \$5 to \$15. If the animals are getting too much protein,

Table 15.3
Suggested nutrient recommendation levels
for lactating dairy goats*

Nutrients	Suggested Levels
Crude protein	15–16%
Undegradable protein	4–6%
Starch	15–20%
Sugar	4–6%
ADF	20–25%
NDF	32–40%
Fat	3–5%
Calcium	.7–.8%
Phosphorous	.3–.4%
Magnesium	.1–.2%
Selenium	0.30 ppm
Vitamin E IU/lb.	9 IU/lb.

* This table was developed by Kevin M. Kouri of Poulin Grain in Vermont as a guideline of nutrient levels in diets for lactating dairy goats.

they must use energy to dispose of it. For example, if a doe eats 100 grams (0.2 pounds) of excess crude protein in a day, she will sacrifice or use up the energy that could have made 130–140 grams (0.3 pounds) of milk.²

MUN is too low when below 12–13mb/100 ml of milk and starts to be too high when above 18mg/100 ml of milk.

When MUN is too high, the manure can become dark and runny. It is not uncommon to see MUNs in the low 20s in grazing goats. This corresponds to a majority of the diet coming from a 23% CP pasture (DM basis). It is recommended to lower the protein in the grain to 12–14% if possible. Increasing the fermentable carbohydrates and energy level of the grain will help the goat use excess pasture protein.

The two general types of protein, categorized by relative speed of digestion in the rumen, are soluble protein and rumen undegradable protein (RUP). *While animals are grazing on high-protein pastures, an RUP% of DM of 15–25% in the grain is desirable to*

balance the high soluble protein. *For the whole diet, RUP% is normally 4–6% diet DM.*

Minerals and Vitamins

After water, energy, fiber, and protein, the next nutrient category to consider is the minerals followed by vitamins in the diet. Exact amounts to be fed to meet the goat's requirements are a challenge to estimate because the minerals come in different forms, each of which has a different availability for digestion and absorption. Forages provide minerals, and the make-up of forages is influenced by minerals in the soil where they are grown. In general, minerals that come from a plant source are more available than rock minerals. That is why soil fertility management is important and having control of growing the forages becomes more crucial. Many purchased minerals are offered as salts; in general, minerals that come as salts, or sulfates, are more available than those that come as oxides. More expensive mineral products are chelated which means the mineral is bound to a more available form like an amino acid. Yeast is sometimes included in mineral mixes; it provides B vitamins and is believed to improve fat levels in the milk. A calcium-phosphorus ratio of 2 to 1 is recommended, and a ratio of crude protein to sulfur of 10:1 is recommended to ensure sulfur is not limiting, especially in diets high in nonprotein nitrogen. In high producing dairy goats, cobalt levels are often short for Vitamin B12 generation with high grain diets.

Feed Considerations

Silage and Haylage as Forage

It is possible to give fermented feeds to goats; however, there are some potential problems. *Listeria*, found in the soil, will proliferate in poorly fermented feed and on the surface of old (exposed) fermented feed. Ingestion of this pathogen can kill goats. Lactic acid should be the predominant end product after good fermentation, while high levels of butyric acid mean a poor fermentation and is bad for digestion in the goat's rumen. Ideally, corn silage should be 28–32% DM and have a pH of between 3.7 and 4.2. Haylage should have 35–40%

Table 15.4
Mineral and vitamin recommendations for lactating 132-pound goat
giving 6.6 pounds of milk per day*

Goat Requirements	INRA	INRA	Langston and NRC	Langston and NRC
Milk/day	<6.6 lbs	>6.6 lbs	3 kg/6.6 lbs	
Nutrient (% or ppm)	% diet DM		% or (mg/kg) DM fed	Daily amount per individual or % of BW
Calcium %	0.70	0.85	0.3–0.8	5.4 gms/goat
Phosphorus (%)	0.35	0.35	0.4–0.5	<1.75% of BW
Magnesium (%)	0.12	0.14	0.180–.14	3.1 gms/goat
Potassium (%)			0.2–2	
Sodium (%)	0.12	0.14	0.2–2	
Chloride (%)			0.2–2	
Iron* ppm (mg)			35–1,000	
Zinc ppm (mg)	50		40–500 mg	
Copper ppm (mg)	10		10–80 ppm	
Manganese ppm (mg)	50		40–1,000	28 mg/goat
Molybdenum ppm (mg)			0.1–1 ppm	
Sulfur (%)	0.20		0.2–0.32%	
Iodine (ppm)	0.20		.8–50	
Selenium (ppm)	0.10		0.3 legally .5-.75 lactating	
Cobalt (ppm)	0.10		0.1–25 ppm	
Boron (ppm)			<150 ppm	
Vitamin A (IU/lb.)			2,000 IU/lb.	50 IU/lb. BW
Vitamin D ₃ ² (IU/lb)			5000 IU/lb.	<45 IU/lb. BW
Vitamin E ² (IU/lb.)**			30 ppm, 9 IU/lb DM	>5.4IU/lb. BW
Niacin (ppm or gm/day)			100-500 ppm,	0.25-0.5 gm/day/goat

*Diet recommendations are indicated with ppm and % in feed; amount per lb BW, % of BW or gms/day indicates daily individual animal intake.

**Grazing animals have adequate diet levels.

Note: INRA is France's national research institute ; LANGS stands for Langston University, Oklahoma; NRC = National Research Council, 1981 and 2007.



Photo 15.2 Feeding a TMR (total mixed ration).

DM and a pH of 4.4–5.0.⁵ Haylage should be olive green and not blackened. If your hands continue to smell when you handle it, that indicates the presence of too much butyric acid, and the feed should not be fed to goats. When harvesting corn silage for goats, cut a high (12 inches above the ground) stubble to prevent soil contamination and chop as finely as possible; $\frac{1}{4}$ – $\frac{3}{8}$ inch is best for goats. This allows for good mixing of a TMR (totally mixed ration) and makes it harder for goats to select out their favorite parts of the diet.

Feed Supplements

The following are examples of feed supplements and their possible uses for dairy goat rations.

Bypass fat (Megalac[®]). This has been used successfully in goats to help balance energy needs in early lactation.

Fishmeal. Internal parasites in the intestines increase protein requirements (due to the protein needed for mounting an immune response, repairing cells, replacing protein lost due to leaking plasma protein, etc.) and diminish the uptake of protein and amino acids across the intestinal wall. Providing goats with bypass protein (fishmeal) up to 8% in their diet will help them resist these parasites. Increased sulfur supplementation may also be called for, since the amino acids lost contain a higher sulfur content. However, excess sulfur inter-

feres with copper and selenium absorption. Check the flavor of the milk!

Sunflower seeds. These provide more energy (with fat and starch) and protein (RUP) with fiber for rumination.

Soy hull and beet pulp pellets. They provide digestible and fermentable fiber. Use when trying to maximize concentrate intake to prevent acidosis and when other fiber sources are low quality.

Soybeans, roasted. Use for RUP when soluble protein intake is high on lush pasture.

Alfalfa pellets. They provide calcium, extra protein, and more energy. Use if forage is low quality.

Barley, oats, wheat. Increase their use in grain when soluble protein in diet, as on pasture, is high. They match the quick digestion of the soluble protein better.

Working with Feed Consultants

It is best to find a feed company that is accustomed to working with dairy goat farms and will provide forage analysis services. To help a feed consultant do the best possible job, provide him or her with the following information:

- milk production in groups of animals (high-low);
- body scores (thin, just right, or fat or 2-3-4);
- milk components; fat and protein percent;
- forage intake, dry matter;
- wasted forage, percent left;
- grain intake, dry matter;
- grazing vs. dry forages vs. silage;
- times of feeding and how often per day.

Langston University's website (www.lurexext.edu/goats/research/bcs.howto.html) has a good factsheet on body scoring of goats. Body scoring is a way to assign a number to a goat based on how fat or thin she is. This will allow an assessment of the energy requirements needed and provide a method to objectively measure changes in the herd's body condition over time.



Photo 15.3 Weighing and body scoring goats.

Ration Balancing Resources

Langston University Nutrient Requirement Calculator is a free ration balancing program for goats that can be found at: WWW.LUREEXT.EDU/GOATS/RESEARCH/NUTR_CALC.HTM

One can use this nutrient calculator to find the goats' energy and protein requirements and to balance rations for these nutrients. There is a technical version that uses metric units and requires a knowledge of some energy conversion assumptions. There is a producer version that is easy to fill out but is based on an old nutritive measurement, TDN (total digestible nutrients) that is not used in research anymore. The program creators provide "Feeding and Management of Lactating Goats" as a fact sheet. To use the calculator, have the following information ready:

Animal Information

- type of goat;
- age and status;
- breed, parity, week of lactation, litter size;
- milk production, fat and protein percent;

- gender;
- weight or heart girth;
- gain desired.

Feed List

- Forage, concentrate, mineral, vitamin, additive
- TDN (total digestible nutrients), CP (crude protein), DM (dry matter) — all taken from laboratory nutrient analysis of feed samples

A new resource that is based on animal status and analysis of the feed is the Small Ruminant Nutrition System, which can be downloaded for free or for trial at WWW.NUTRITIONMODELS.TAMU.EDU/SRNS.HTM

It is very useful in checking the diet against the goat's requirements and it incorporates influential factors like temperature and exercise. A more extensive analysis of the feeds will need to be supplied including NDF (fiber), percent NFC (nonfibrous carbohydrates or starch), soluble protein as percent of crude protein, percent fat and percent ash.

The U.S. National Research Council has recently (2007) revised the *Nutrient Requirements of Small Ruminants*, which is available for purchase at WWW.NAP.EDU/. It is written primarily for researchers, but the nutrient requirement tables are useful.

The Department of Animal Science at the University of California at Davis has released CAPRICORN, a computer software CD for formulating and analyzing rations for goats: WWW.ANIMALSCIENCE.UCDAVIS.EDU/EXTENSION/SOFTWARE/CAPRICORN/. It is based on the newest NRC nutrient requirements (2007 edition mentioned above).

Also available for purchase are a book and CD-ROM by David Tisch called *Animal Feeds, Feeding and Nutrition, and Ration Evaluation*. It uses the old 1980 NRC requirement tables but allows users to select feeds and formulate rations.

Recently, Dr. Susan Schoenian, University of Maryland Extension, has added a ration mixer tool for goat or sheep rations on her Maryland Small Ruminant website, WWW.SHEEPANDGOATS.COM. She also lists many other articles and links about goat nutrition.

In March 2010, Dr. Sandra G. Solaiman finished a great resource book *Goat Science and Production*, published by Wiley-Blackwell. It is available at WWW.

WILEY.COM OR FROM WWW.AMAZON.COM. It contains chapters on dairy goats, nutrition and housing based on the most current research and includes the 2007 NRC goat nutrient requirement tables.

ENDNOTES

1. *Nutritional Ecology of the Ruminant*, second edition, Peter Van Soest, 1994, Cornell University Press.
2. "Balancing Diets for Goats," Antonello Cannas, presentation in Vermont 2006.
3. *Effect of Age and Stage of Lactation on Dry Matter Intake and Milk Production in Alpine Does*, H.A. Randy, C.J. Sniffen, J.F. Heintz, *Small Ruminant Research*, 1(1988), pp. 145–149.
4. *Dairy Goats Feeding and Nutrition*, Edited by A. Cannas and G. Pulina, CAB International 2008. WWW.CABI.ORG
5. "Silage for Goats," John Himba, *Dairy Goat Journal*, May/June 2008, pp. 30–32.



CHAPTER 16

Grazing and Browsing Basics

Carol Delaney

Grazing and browsing are the natural ways for goats to feed themselves. Here are some reasons to have the goats harvest their own feed:

- you could lower your total feed costs by 25% (less hay or purchased forages);
- less cleaning and spreading manure will mean less labor needed in barn;
- cost of bedding will be lower;
- goats will be healthier in terms of muscle tone and healthy skin as they garner Vitamin D from the sun and Vitamins A and E and many minerals from the fresh forage;
- it is estimated that up to 4–6 pounds of milk production can be supported by forage alone with no concentrate supplementation.

Some challenges associated with grazing and browsing are following:

- goats do not like to be in the cold, driving rain because they have thin external fat layers;
- milk production will vary more with weather and daily changes in forage quality;
- older goats that have not grazed before will not know how to do it and may need a couple of seasons to learn;

- goats are susceptible to gastrointestinal parasites ingested while grazing pastures;
- deer have a parasite (*p. tenuis*) that can be transferred to goats through snails and can cause partial paralysis if untreated with aggressive doses of antibiotics and dewormers;
- whereas overall cost of feed will be lower, the daily milk production will fluctuate with the weather and quality and quantity of forage and browse.

Does Grazing Really Save Money?

In 2001, the author contract-raised 8 replacement doelings for 3 months on browse and organic grain (1.5 pounds per day for desired weight gain). The feed cost, including 19 bales of hay, grain and a salt block was about \$0.23 per goat per day while the forage was mostly sumac saplings and goldenrod. It was estimated that the 8 doelings would have eaten an additional 83 bales of hay in the same 3-month period. The difference in feed cost would have been about \$150, or \$1.20 per day, with labor and infrastructure costs being the same or less for pasture care. So, almost \$1 per day per goat was saved in feed costs alone.



Photo 16.1 Goat enjoying grass.

Around that same time, two successful commercial dairy goat farms with radically different management approaches were assessed for milk production and feed cost. Farmer A had a seasonal, pasture and browse based organic goat dairy that turned its milk into cheese for retail and wholesale markets. Farmer B managed her goats as a year-round total confinement herd and sold the milk to a creamery. Table 16.1 summarizes the 2 years we compared them for milk production, feed cost of production and profit over operating expenses (capital expenses were not included).

While the comparison is between just 2 farms, one can see that the farm reliant on pasture, even though it purchased organic concentrate at about twice the price of conventional concentrate, had noticeably lower expenses. The cost to produce milk was about 75% that of the confinement farm and the profit was higher by about 12–25%, depending on the year. Thus, this demonstrates that implementing a grazing and browsing system could decrease costs and increase profits.

Can Pastures and Browse Support Milk Production in Dairy Goats?

One can calculate that by analyzing the pasture and assuming that the goats will eat it. Jean-Marie Luginbuhl, North Carolina State University, provides us with an image to explain this. In Figures 16.1 and 16.2, we see that vegetative pasture can provide the energy requirements of lactating does and oversupplies them with protein

High quality forage alone has been found to support 4–6 pounds of milk production per day. However, it is generally hard to supply all the minerals and match the energy digestion with the rate of protein digestion on pasture alone.

From a study in Vermont funded by a USDA SARE grant, many data was collected on Vermont dairy goat farms that utilized pasture to a great degree during the growing season in Vermont. In

Table 16.1
Comparison of income and expenses for farm A (pasture-based, seasonal production)
and farm B (confinement, year-round production)

		Farm A – Pasture	Farm B – Confinement
Feed cost per cwt milk (\$)		10.30–11.40	14.70–17.40
Feed cost per total expenses (%)		44–47	50–54
Variable costs/lb of milk (\$)		0.23–0.24	0.30–0.32
Profit over variable cost/lb milk (\$)		0.09–.10	0.06–.08
Average annual milk yield (lbs per goat)	Year 1	1738	1530
	Year 2	1384	1647

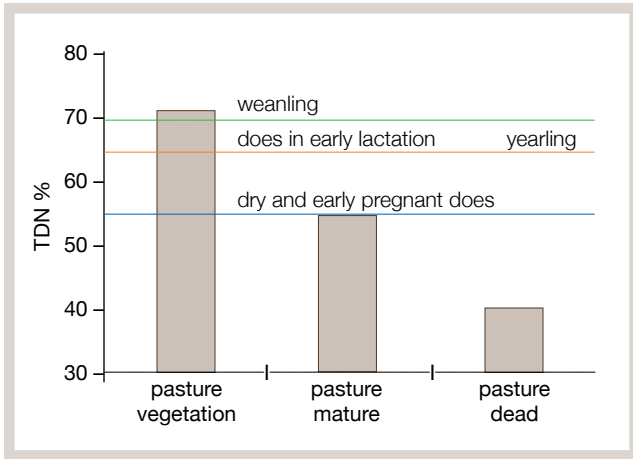

Figure 16.1 Forage quality and goat energy requirements (TDN). J-M Luginbuhl, NCSU.

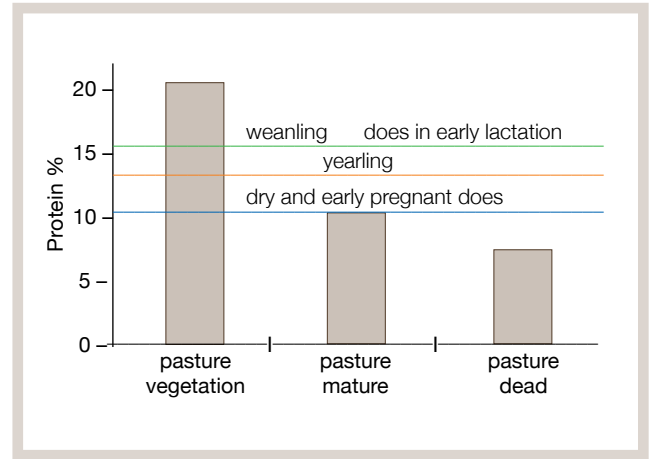

Figure 16.2 Forage quality and goat protein requirements. J-M Luginbuhl, NCSU.

the graph in Figure 16.3, the average annual daily milk production for these farms ranged from 4.9 to 6.8 pounds per day. While Farm 1 was a confinement herd, Farms 2–7 relied on pasture to varying degrees in the summer. On pasture-based farms,

the average lactation length was 9 ± 1 months. The total average milk production over the entire lactation was 1650 pounds per goat. The average cost of grain to support the production of 100 pounds of milk was $\$10 \pm 0.03$.

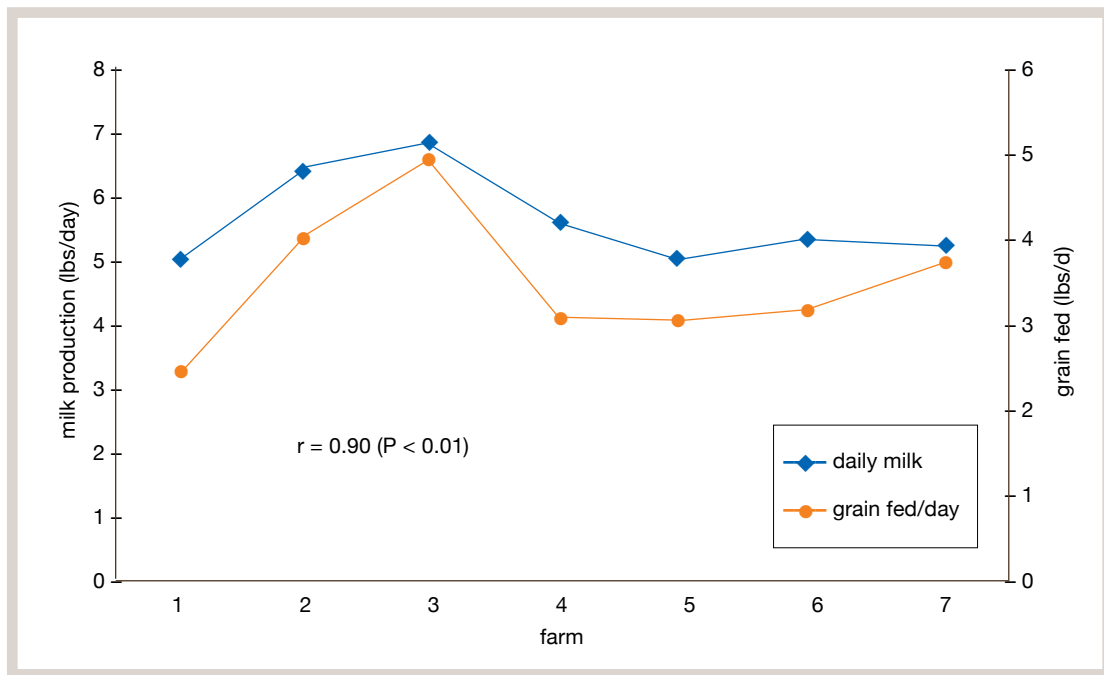

Figure 16.3 Average daily milk production on dairy goat farms with corresponding concentrate intake.

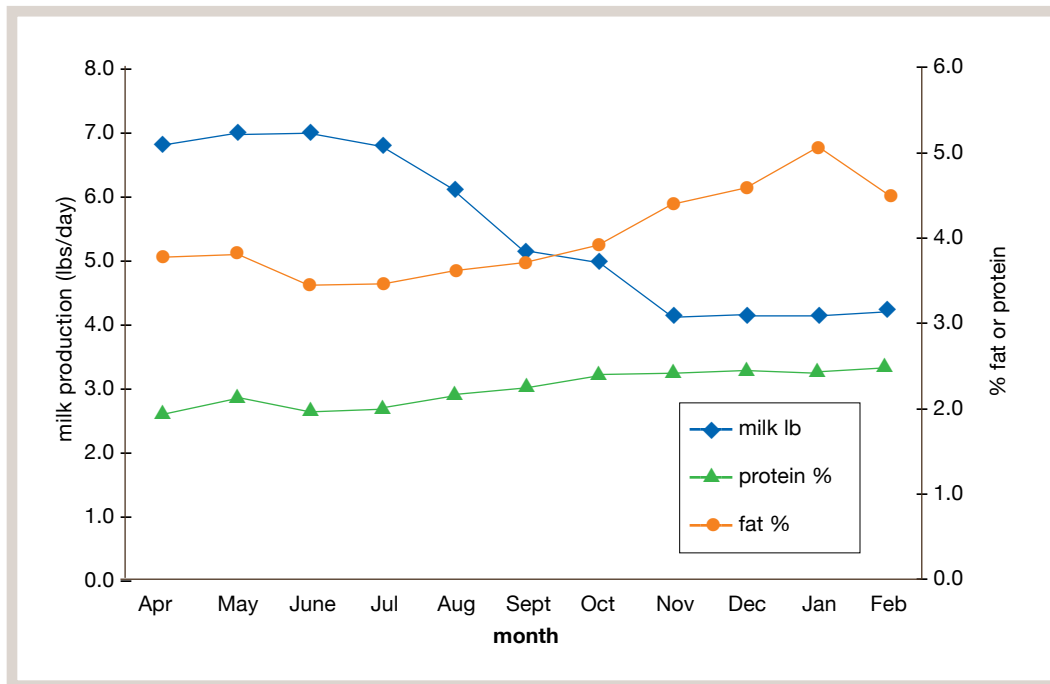

Figure 16.4 Average milk production and % components over lactations of 6 grazing dairy goat herds.

Grazing and Browsing Behavior

Unlike sheep and cows, goats select from different parts of the plant and will walk and climb to seek more plants to get a variety in their diet. In general, goats graze the top of the pasture canopy first before grazing down to the ground. They will balance on their hind legs to reach up to 6 feet and use their legs to pull down branches. Given the choice, they would include grasses, weeds, and woody species in their daily diet. In the spring they will gravitate more toward grasses and, after a month or two, will desire more of a mix of leaves and weeds. This is useful because weed and shrub leaves maintain their nutrient quality, while the quality of grasses will decrease as the season becomes hotter. From mid-spring until 200 days later, at the end of the growing season, the digestibility of the different grass parts declines.

In the summer, as the mean temperature rises above 50–77°F, more and more grazing will occur at night. In the Mediterranean, the sound of bells of grazing goats encourages other goats to graze at night, when visual stimulation is lacking.

Goats vary the plant species they select throughout the season. Thus, land with diverse terrain and plant species, including woody plants, shrubs, and perennial and annual forages, allows the goat to fulfill its evolved trait of specialized selection of plant parts. Table 16.3 shows a comparison of plant species that domestic ruminants choose to eat during the year, taken from *Dairy Goats Feeding and Nutrition*¹.

Goats avoid areas of urination and defecation. Therefore, for lactating goats, it is best to move them every 12–24 hours. They require a high-quality

Table 16.2
Digestibility changes of plant parts of annual grasses from start to end of growing season²

Plant Part	Digestibility Decreases TDN % Start vs % End of Season
Leaf	85% to 65%
Sheath	80% to 60%
Seed head	80% to 43%
Stem	70% to 20%

²Nutrient Requirements of Small Ruminants, 2007.



Photo 16.2 Goats enjoying browse.

ity feed, so it works well to allow the does to select their preference of the top of the swath and then bring in a follow-up group, such as cattle or horses, to harvest the remaining forage. This will also allow goats to graze above the level where the infective worm parasite larvae are residing (up to 5 inches on grasses).

Because goats are very good at selecting feed, this feature can be used to allow them to balance their diets for themselves. Eating a variety of forages will help keep their rumen functioning well and their nutrient needs met. In fact, it has been shown that, as pasture quality decreases, goats become better selectors and maintain the quality of their diet longer before trying to eat more low-quality feed to

Table 16.3
Forage species preferred by ruminants over the growing season

Composition of the diet (%) for type of plants.¹

	Spring	Summer	Autumn	Winter
Trees				
Goat	5	76	45	38
Sheep	3	18	15	4
Cow	2	10	5	3
Bushes				
Goat	7	11	27	28
Sheep	2	11	10	4
Cow	2	4	4	3
Grasses				
Goat	88	13	28	34
Sheep	95	71	75	92
Cow	96	86	91	94

¹*Dairy Goats Feeding and Nutrition*

meet their needs. This is the opposite of what sheep and cows tend to do.

Below is a figure taken from *Dairy Goats Feeding and Nutrition*¹ that shows how lactating goats spend 70% of the time they are outside foraging actually eating versus resting (<5%), searching (~25%), or moving (<5%) in comparison with other life stages.

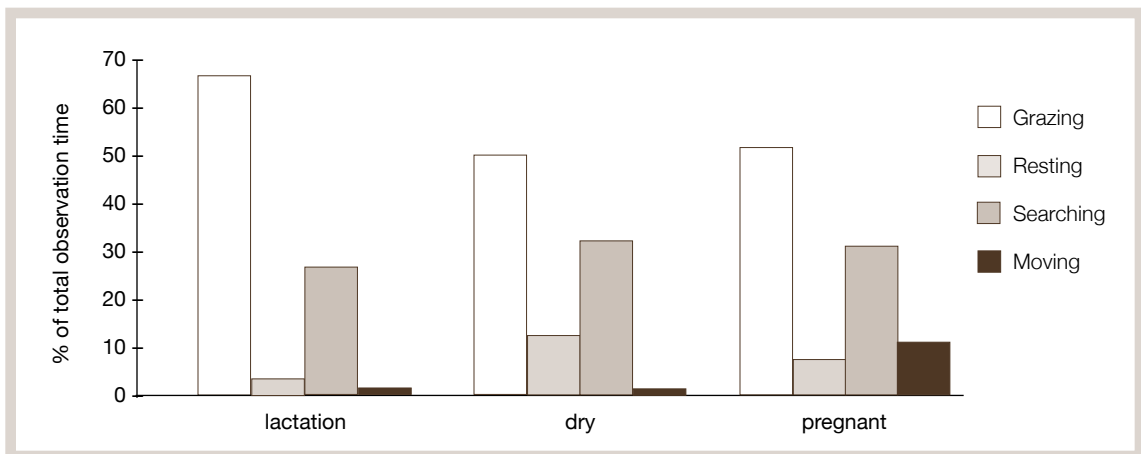

Figure 16.5 Comparison of daily activities by lactating, dry and pregnant goats.¹

Land Base Need for Forages and Pasture

How much land will you need? Start with 0.14 acre/goat/year for the area just for grazing. If you include the forage needed for the goats year-round, use a figure of .25–.33 acres per adult goat per year to provide the winter forage. Besides that, add an estimate of .1–.4 acres of browse per goat. These are just ballpark figures to help you get started because goat size and the productivity of different plant species on different soils vary widely.

Plant Species for Pasture and Browse³

Goats will eat cool-season grasses such as orchard, bluegrass, ryegrass, Kentucky bluegrass, timothy, and reed canarygrass. Warm summer annuals such as pearl millet and crabgrass and perennials like switchgrass are palatable to goats, too. Other perennials to consider planting are legumes like alfalfa, birdsfoot trefoil, ladino clover, and red clover. Summer annuals that can be grazed are soybean, cowpeas, crimson clover, and hairy vetch. For annual cereal grains, if there is an option to seed down a field, consider cereal rye, barley, oats, triticale, or wheat. These can be grazed throughout the season, and it is recommended to mix different grains in a field to balance each crop's early- and late-producing attributes. Improved herbs or forbs include the perennial chicory (which helps with internal parasite suppression) and annual mustard family crops that can be grazed or grown for their roots. Examples of these are turnips, rape, kale, and rutabagas. Be aware that lactating does may transfer the sulfur-smelling compounds from these cole mustard crops to their milk after grazing. Choose to graze them right after milking and allow 6–8 hours of lag time after grazing before the next milking, or graze only nonlactating animals on that type of forage.

Shrubs and woody species, including many deciduous trees, could be maintained in a separate area to allow for controlled foraging times to prevent plant death by overeating. These could include willows, maples (striped), beech, birch, and black locust (can be toxic in sudden, large amounts), as well as many deciduous trees, staghorn sumac, brambles, honeysuckle, red-stemmed dogwood,

and multiflora rose. Plants with thorns pose no problems for goats' small muzzles and nimble lips and tongues. Goats select their forage with their lips and tongues and guide it down their throats.

Sample Paddock Size Estimation

Most paddock sizes are estimated and then adjusted through experience. For assistance, become a member of the your local pasture or grass association like the Vermont Grass Farmers' Association and the Vermont Sheep and Goat Association. Learn about public and private consultants through your university Extension and NRCS offices, which will give you dry-matter (DM) estimates to work with.

Below is a sample calculation of paddock size for 16 milkers weighing an average of 130 pounds and producing 8 pounds of milk per day:

- concentrate is 3 pounds DM/day or 2.3% body weight (BW); forage intake is estimated at 2.1% BW;
- 16 goats x 130 lbs/goat = 2080 lbs BW;
- 2080 lbs BW x 2.1% (.021) = 44 lbs DM;
- grazing 7 inches down to 4 inches gives (2,400 – 1,400 DM/acre = 1000 DM/acre);
- 44 lbs DM per day ÷ 1,000 lbs DM/acre = 0.044 acres;
- 0.044 acres x 43,560 ft² = ~1,916 ft², or a 40 ft x 48 ft paddock.

Tips on Grazing Goats for Milk Production

1. Build a perimeter fence that is 5–6 strands, at a height of no less than 42 inches (up to 48 inches). Suggested wire intervals (inches from ground): 6", 6", 6", 8", 8", and 10". High-tensile fence is cheaper in the long run. Nonelectric woven wire livestock fence costs more and will require a single electric wire along the inside at about goat nose height to keep them from climbing on it. This woven wire fencing still requires tension and bracing for proper installation. Some brands are made of high-tensile wire and maintain their vertical alignment very well. A single wire on the outside of both types of fences somewhere in the bottom 14 inches will help to deter predators.

2. Subdivide paddocks with temporary mesh electric netting or three strands of polywire in as square a shape as possible. Rectangular paddocks are fine as long as they are not so narrow that the goats might be pushed into the fence frequently.
3. Young kids, being hungry and inquisitive, will teach themselves how to graze. Kids will also learn from other animals that graze. Older does that have not grazed may take 1–2 seasons to learn; they will learn from a herd with grazing leaders.
4. Practice 12–24-hour grazing by shutting goats into paddocks. Move water with milking goats. Keep water free of manure.
5. Start grazing at up to 8–12 inches down to 5–6 inches, depending on the season. In the spring, start at a lower height to control forage regrowth and quality.
6. Control internal parasites by
 - not grazing the same area twice in a year;
 - adding another species (such as cattle or horses) in a sequential grazing rotation;
 - putting goats in a field after the dew has dried;
 - selecting animals that do well with minimal deworming;
 - deworming only when necessary for individuals;
 - including browse and weedy areas as part of the grazing system, especially in midsummer.
7. Include some dry, first-cut hay in the barn before milking if the quality of the pasture is high and concentrates are fed in the parlor. Some farmers feed up to 0.5–1.0 pounds of hay per goat per day in the barn along with pasture and browse.

Supplementation for Goats on Pasture and Browse

Goats are such good selectors of parts of plants from a daily variety of plant species that they offer a challenge to the person trying to balance the ration with

a concentrate fed in the barn. How much concentrate to feed and of what formulation are the basic questions. Refer to Chapter 15, “Feeding Dairy Goats.”

First, milk production is what drives does to eat, more than the influence of their body weight. In other words, the energy needs of milk production are responsible for the increase of DM intake and time eating and searching for feed. As time foraging is a major limiting factor to how much a doe can eat, supplementing with grain can provide her with the energy needed to produce that extra milk and keep her body in good condition. A grain mix is a good means of providing the minerals and vitamins needed to support body functions and milk production, too.

Generally speaking, there are some feeding concepts to apply:

- if you want to maximize forage-based milk production, try to feed no more than 1 pound of concentrate at one time (in the parlor, for example). Feeding more than $\frac{1}{4}$ to $\frac{1}{3}$ of the DMI as grain encourages the starch digesting microbes to produce a lot of acid which lowers the effective pH range for the fiber digesters. To get more concentrate into the goat, feed grain 2–4 times per day;
- based on past studies and grain prices, dairy goats respond to more concentrates fed in a profitable fashion with more milk production. With a Saanen grazing herd, researchers found a rule of thumb was to feed 1 pound of grain for every 3 pounds of milk. Recent research in Vermont showed that milk production is highly correlated with grain fed. The average cost of grain per 100 pounds of milk was \$10;
- is feeding no grain possible? If you sacrifice body condition of the goat, you can select for does that produce acceptable amounts of milk with less and less grain. In a study sponsored by the Northeast Sustainable Agriculture Research and Education program, Bruce Clement and others found that does fed no grain produced the same amount of milk as does fed 1.5 pounds of grain per day. (See the final

report at WWW.SARE.ORG BY USING THE KEYWORD LNE98-108 IN PROJECT REPORTS/).

Their conclusion was that if you feed less than 1.5 pounds of grain per day, you might as well feed no grain, as far as milk production and economics are concerned. However, does with no grain (or less grain than would maximize their milk production) will lose more weight, will need more time to gain back the weight, and will be more susceptible to health and parasite challenges. Feeding no grain will necessitate a good source of free-choice minerals from a reliable source. If feeding little grain is a criterion in your farm plan, the measurement and selection of does that remain healthy, graze well, and produce acceptable amounts of milk will be important records to keep.

Feeding protein in the grain decreases pasture intake. Pasture intake is best predicted ($R^2 = 0.41$, $p < 0.01$) with this equation¹:

$$\text{Pasture intake (gms DM/day)} = 822.111 - 6.188 \text{ gms CPS} + 0.138 \text{ FCM} + 9.131 \text{ BW}$$

Whereas:

DM = dry matter

CPS = grams/day of crude protein given in the grain

FCM = grams of 5% fat-corrected milk

BW = body weight of animal in kilograms

Examples of Intakes and Milk Production of Goats Grazing and Fed Green Chop:

- seasonal grazing in France, 2000. Optimum grain fed on quality pasture was 1.75 pounds for 6.4–8 pounds milk per day;

¹ R^2 is the proportion of the variability of DMI that can be explained by the equation. A $p < 0.01$ means the researchers are 99% confident that this equation is accurate and not due to change in their data collection.

- partial grazing year-round, 100% outdoor herd, New Zealand, 1998. 4 pounds milk per day in midlactation. Daily DMI: 2 pounds cracked corn, plus 0.55 pounds pasture and chicory and 1.75 pounds pasture silage;
- confinement, green chop, New Zealand, 1998. 5.3 pounds milk per day in midlactation; Daily DMI: 1.1 pounds concentrate, plus 1.75 pounds green chop and ad lib pasture silage.
- grazing, Minnesota, 1999. Grazing does weighing 130 lbs at 8–12 pounds milk per day. Total daily DMI: 4.4–5.1% BW. 2.3–3% BW concentrate (minimum 3 pounds concentrate) and 2.1% BW forage or 2.75 pounds pasture;
- pasture and by-products, Mexico, 1995. 3.3 pounds milk per day average over 256 days, milked once per day by hand. Standard goat considered to be 121 pounds. Daily DMI: 4.2% BW or 5.1 pounds (yearly average). DMI concentrate: 1.0% BW or 1.1 pounds. DMI forage: 3.2% BW or 4 pounds;
- pasture, Vermont, 1999. 8 pounds milk/day, mid to late lactation, 150-pound does, lush, 8-inch pasture. DMI forage estimated: 2.65–3.1 pounds or 1.8–2% BW. DMI concentrate: 2.7 pounds average or 1.8% BW.

ENDNOTES

1. *Dairy Goats Feeding and Nutrition*, Edited by A. Cannas and G. Pulina, CAB International 2008. WWW.CABI.ORG. Table 16.3 is Cannas' adaptation from Fedele, V. 2001, Alimentazione, tra pascolo e integrazione. Caseus 3, 36–43.
2. *Nutrient Requirements of Small Ruminants*, NRC, 2007, The National Academies Press.
3. *Meat Goat Production Handbook*, Compiled by T.A. Gipson, R.C. Merkel, and S. Hart, American Institute for Goat Research, E(Kika) de la Garza, Langston University, Guthrie, Oklahoma.



CHAPTER 17

Hay: Buy It or Bale It

Chet Parsons

One of the issues that goat and other small farmers struggle with is whether to buy their hay or make it themselves. If hay land is available, it may make sense to make your own, especially as small bales become harder to find. The biggest drawbacks to making hay are the substantial investment in the appropriate machinery and the uncertainty of the weather.

The minimum machinery required to make hay includes a tractor, a mower, a tedder, a rake, and a baler. Some method of transporting the hay to the barn is also required: either a truck or wagons. As farmers get bigger and upgrade their equipment, used equipment that can be purchased at a reasonable price—at least compared to new equipment—becomes available. Of course, as with buying anything used, the cost of repairs can be substantial and must be considered.

Reliable used machinery will probably cost between \$15,000 and \$20,000 total. A minimum-sized tractor, 50 horsepower or more, will probably cost in the range of \$7,500. A sickle-bar mower or mower-conditioner will be between \$2,500 and \$3,000; if you go to the preferred mower, one that cuts with disks, the cost will be more in the range of \$5,000 to \$7,000. A tedder is required to fluff up the hay to ensure that it dries down evenly. This

will cost between \$1,000 and \$1,500. Next, a rake is required to rake the hay into a windrow for baling. A good used rake will cost about \$2,000. Finally, a baler is required to bale the hay. As more farmers upgrade to large round balers, there are good, small, rectangle balers available; but they can still cost up to \$3,000. If we add a wagon, at \$1,500, the total will look something like this:

Table 17.1
Estimated Used Equipment Cost*

Equipment	Price (\$)
Tractor	\$ 7,500
Mower	\$ 2,500
Tedder	\$ 2,000
Rake	\$ 1,500
Baler	\$ 3,000
Wagon	\$ 1,500
TOTAL	\$18,000

* Prices based on information obtained from Rene J. Fournier Equipment in Swanton, Vermont, September, 2010.

If we amortize the cost of the equipment over five years, it comes to \$3,600 per year. As mentioned pre-



Photo 17.1 Tractor, baler, and wagon.

viously, the cost of repairs on used equipment can be substantial and is hard to predict. For the sake of this chapter, we will budget another \$3,600 per year for repairs. If the amortization of the machinery and the estimated repair cost per year equals \$7,200 and you make 2,500 bales per year, the cost would be \$2.88 per bale.

This does not include time, fuel, oil, grease, baler twine, or fertilizer. It also does not include costs such as taxes, insurance, or interest. The other real unknown is the weather. If it turns out to be a poor weather year, you can end up with poor hay and have to pay the same expenses.

Making hay in the Northeast can be a challenge. Early vegetative stage makes the best hay. To get that, hay must be cut early in the season, late May or early June, for the first cutting. The weather is very unpredictable at this time of the year, and it can be almost impossible to get hay dry enough to bale. That is why you see more and more small farmers using the large, wrapped round bales.

To preserve hay, it must be dried or fermented to stop the microbial action that causes it to spoil or rot. Hay has to be dried to at least 18% moisture to prevent spoilage. This can take up to three days of good drying weather early in the season. However, if you

ferment it by putting it in wrapped round bales, the moisture content can be much higher and the hay require much less drying time in the field. When the bale is wrapped, oxygen is eliminated from the hay. That causes a different microbial population to grow in the bale. As that happens, the environment inside the bale becomes acid. When it gets below a pH of 5, the microbial action ceases, and the bale is preserved as long as it remains airtight.

Unfortunately, preserving hay with wrapped round bales creates other problems. The cost of a large round baler and a wrapper will increase the cost of your equipment by at least \$15,000. As the bales are heavy, weighing between 500 and 1500 pounds, extra equipment may be needed to move them. Feeding the bales can create another challenge. Not all barns are set up to accommodate such large bales. Modifications to the barn may have to be made or special feeders made or purchased.

If that isn't enough, there is still the possibility of introducing listeriosis to your goats with improperly fermented forage. If a bale does not get properly wrapped or the plastic gets cut, it will not ferment properly, and the feed will not drop below the required 5 pH. If that happens, mold and other organisms such as listeria could grow in the forage. That can cause your animals to get sick or even die. If you do feed fermented feed, discard any that appears to be moldy.

Another option is hiring someone to do your haying for you. A local farmer or custom operator may be available. A local farmer may agree to do your haying for a portion of the hay.

In the end, purchasing your feed may be the best option. It doesn't have to be limited to just hay. A larger farmer in your area may have haylage or corn silage available. In some cases, the farmer may be able to make a total mixed ration for you.

Feeding animals can always be a challenge. It's wise to explore all options for providing feed to your animals before you make a large investment.

APPENDIXES

Please note that organizations, contact personnel and website links frequently change. Use keywords in a web browser to locate the most current information. Please contact Carol Delaney for additions and corrections at CDHORNOFPLENTY@GMAIL.COM

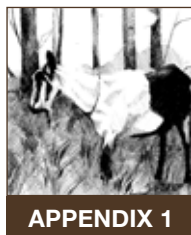

Resources

Recommended Books and Articles

Building a Sustainable Business: A Guide to Developing a Business Plan for Farms and Rural Businesses.

SARE Handbook 6, 2003. Free as a download or order from WWW.SARE.ORG/LEARNING-CENTER/BOOKS

Dairy Goat Management: Best Management Practices,

Clara Hedrich (University of Wisconsin Emerging Agricultural Markets Team, April 2008, WWW.WDGA.ORG/RESOURCES/BMP1.PDF).

Dairy Goats Feeding and Nutrition, A. Cannas and G.

Pulina, eds. (CAB International, 2008, WWW.CABI.ORG/CABIPAGES).

Dairy Goats: Sustainable Production, Linda Coffey,

Margo Hale, and Paul Williams (ATTRA, WWW.ATTRA.NCAT.ORG/ATTRA-PUB/DAIRYGOATS.HTML).

Dairy Practices Council, 19 Titus Court, Richboro,

PA 18954, WWW.DAIRYPC.ORG, DAIRYPC@DAIRYPC.ORG. phone/fax 215-355-5133. Publishes educational guidelines for large and small ruminant dairy farmers. Non-profit organization of education, industry and regulatory personnel concerned with milk quality, sanitation, and regulatory uniformity.

“Effect of Age and Stage of Lactation on Dry Matter Intake and Milk Production in Alpine Does,” H. A. Randy, C. J. Sniffen, J. F. Heintz, *Small Ruminant Research*, 1 (1988): 145–149.

The Farmstead Creamery Advisor, The Complete Guide to Building and Running a Small, Farm-Based Cheese Business, Gianacis Caldwell, Chelsea Green Publishing, 2010.

Goat Farming, 2nd ed., Alan Mowlem (Farming Press, Ipswich, UK, 1996). WWW.WHSMITH.CO.UK

Goat Medicine, Mary Smith and David Sherman, 2nd Edition, Wiley-Blackwell, 2009

The Goatowner’s Guide to Milking Machines, Diane Gray, Stringalong Enterprises, Wauchula, Florida, 1997. ISBN 1-929492-01-4.

Goat Production Manual, 2nd ed., Marion Smart, DVM, Ph.D., Juniverse Inc, 2010

Goat Science and Production, Sandra G. Solaiman, Wiley-Blackwell Publishers, March 2010.

Holistic Management Handbook: Healthy Land, Healthy Profits, Allan Savory et al. Island Press, 2006.

Meat Goat Production Handbook, T. A. Gipson, R. C. Merkel, and S. Hart (American Institute for Goat Research, E [Kika] de la Garza, Langston University, Langston, OK).

Natural Goat Care, Pat Coleby (ACRES USA, Austin, Texas, 2001).

Nutritional Ecology of the Ruminant, 2nd ed., Peter Van Soest, Cornell University Press, 1994.

The Organic Farmer's Business Handbook: A Complete Guide to Managing Finances, Crops and Staff – and Making a Profit. Richard Wiswall. Chelsea Green Publishing, White River Junction, Vermont, 2009.

Raising Goats for Meat and Milk, Rosalee Sinn (Heifer International, 2008), 1 World Avenue, Little Rock, AR 72201.

“Silage for Goats,” John Himba, ***Dairy Goat Journal*** (May/June 2008): pp. 30–32. WWW.DAIRYGOAJOURNAL.COM/ISSUES/86/86.../JOHN_HIBMA.HTML

Simply Meat Goats, Sandra G. Solaiman, George Washington Carver, Ag. Exp. Station, Tuskegee University, Tuskegee, AL, 36088, January 2007.

Periodicals and Informational Websites

Acres USA Magazine

PO Box 91299
Austin, TX 78709
800-355-5313, 512-892-4400

WWW.ACRESUSA.COM, INFO@ACRESUSA.COM.

A voice for eco-agriculture. Magazine, book catalog, and educational events.

Agricultural Marketing Resource Center (AgMRC)

1111 NSRIC
Ames, IA 50011-3310
866-277-5567

WWW.AGMRC.ORG, AGMRC@IASTATE.EDU

Provides independent producers and processors with information on building successful value-added agricultural enterprises. Good database on food and animal production issues consumers care about.

The Amazing Goat blog

Dr. Marion Smart
Small Animal Clinical Sciences Western College of
Veterinary Medicine
University of Saskatchewan
Saskatoon, Canada

WWW.THEAMAZINGGOAT.BLOGSPOT.COM/

Appropriate Technology Transfer for Rural Areas (ATTRA)

PO Box 3657
Fayetteville, AR 72702
800-346-9140

WWW.ATTRA.NCAT.ORG

A national sustainable farming information center addressing production practices, alternative crop and livestock enterprises, and innovative marketing. Publications for goats and sheep.

Dairy Goat Journal

145 Industrial Dr.
Medford, WI 54451
715-785-7979, 800-551-5691
WWW.DAIRYGOATJOURNAL.COM
CSYEDITORIAL@TDS.NET

Dairy Practices Council

19 Titus Court, Richboro, PA 18954
WWW.DAIRYPC.ORG
DAIRYPC@DAIRYPC.ORG
phone/fax 215-355-5133

Publishes educational guidelines for large and small ruminant dairy farmers. Non-profit organization of education, industry and regulatory personnel concerned with milk quality, sanitation, and regulatory uniformity.

GoatLinks.com

WWW.GOATLINKS.COM
Goat breeder advertising website.

Graze!

Published by Joel and Ruth McNair
PO Box 48, Belleville, WI 53508
608-455-3311
WWW.GRAZEONLINE.COM
GRAZE@ONLINE.COM

Great Lakes Dairy Sheep Symposium Proceedings

Spooner Agricultural Research Station
W6646 Hwy. 70
Spooner, WI 54801
715-635-3735
WWW.UWEX.EDU

Maryland Small Ruminant Page

WWW.SHEEPANDGOAT.COM

National Institute for Animal Agriculture

13570 Meadowgrass Drive, Suite 201
Colorado Springs, CO 80921
WWW.ANIMALAGRICULTURE.ORG
NIAA@ANIMALAGRICULTURE.ORG

*Publishes **Sheep and Goat Health Report**, videos and books. Membership organization for industrial ag. and animal scientists.*

New England Journal of Large Animal Health

140 Main St.
PO Box 1160, Chester, VT 05143
802-875-4889, 866-655-4889, fax 802-875-1797
INFO@NEAHI.ORG

***Oklahoma State University Quicken Newsletter
(OSU Quick Tips)***

529 Agricultural Hall
Stillwater, OK 74078
405-744-9831
WWW.AGECON.OKSTATE.EDU/QUICKEN/
Da-mona Doye
DAMONA.DOYE@OKSTATE.EDU

***Ontario Ministry of Agriculture, Food and
Rural Affairs***

WWW.OMAFRA.GOV.ON.CA

***Poisonous Plants Informational Database
(Cornell University)***

WWW.ANSCI.CORNELL.EDU/PLANTS

Ranch & Rural Living

P O Box 2678
San Angelo, TX 76902
325-655-4434
WWW.RANCHMAGAZINE.COM
INFO@RANCHMAGAZINE.COM

Sheep and Goat Marketing

WWW.SHEEPCOATMARKETING.INFO/

Sheep Canada

1489 Rt. 560
Deerville, NB, Canada E7K 1W7
888-241-5124
WWW.SHEEPCANADA.COM
GALLIVAN@SHEEPCANADA.COM

Sheep! Magazine

145 Industrial Dr.
Medford, WI 54451
715-785-7979, 800-551-5691
WWW.SHEEPMAGAZINE.COM, SHEEPMAG@TDS.NET

The Shepherd Magazine

5696 Johnston Rd.
New Washington, OH 44854
ATTAR.NCAT.ORG/ATTAR-PUB/SHEEP.HTML

Small Ruminant Dairy Newsletter

Archived at:
WWW.UVM.EDU/SUSTAINABLEAGRICULTURE/SMALLRUMI.HTML

Small Ruminant Research Journal

WWW.ELSEVIER.COM/WPS/FIND/JOURNALDESCRIPTION.CWS_
HOME/503317/DESCRIPTION#DESCRIPTION, WWW.ELSE
VIER.COM/LOCATE/SMALLRUMRES

***Southern Consortium for Small Ruminant
Parasite Control***

WWW.SCSRPS.ORG

Stockman Grass Farmer

PO Box 2300
Ridgeland, MS 39158
800-748-9808
WWW.STOCKMANGRASSFARMER.NET
SGF@STOCKMANGRASSFARMER.COM

Sustainable Agriculture Network (SAN) Publications

WWW.SARE.ORG/PUBLICATIONS/ALL_PUBS.HTM

Temple Grandin

WWW.GRANDIN.COM
Designer of animal pens and chutes for low stress.

United Caprine News

PO Box 328
Crowley, TX 76036
817-297-3411
WWW.UNITEDCAPRINENEWS.COM
EDITOR@UNITEDCAPRINENEWS.COM
*Monthly periodical serving all aspects of the dairy goat
industry.*

University of Wisconsin-Madison

WWW.UWEX.EDU/CES/ANIMALSCIENCE/SHEEP/
*Sheep management website with dairy sheep symposium
proceedings.*

USDA Healthy Animal Newsletter

WWW.ARS.USDA.GOV/IS/NP/HA

***Academic and Outreach/Extension
Educational Programs***

***Centre de Référence en Agriculture et Agroalimentaire
du Québec (CRAAQ)***

2875 boulevard Laurier
Québec City, QB, Canada G1V 2M2
418-523-5411 (Québec and vicinity)
888-535-2537 (all of Canada)
WWW.CRAAQ.QC.CA (in French)
CLIENT@CRAAQ.QC.CA

CORNELL UNIVERSITY

Extension Learning Farm

1894 State Highway 68
Canton, NY 13617

Betsy Hodge
315-379-0607

BETSYHODGE@TWCNY.RR.COM

Small ruminant education and marketing assistance

Cornell Sheep/Goat Program

Mike Thonney, sheep specialist
607-592-2541

WWW.SHEEP.CORNELL.EDU

MLT2@CORNELL.EDU

Tatiana Stanton, goat specialist
Morrison Hall, Room 114
Cornell University, Ithaca, NY 14853
607-254-6024,

TLS7@CORNELL.EDU

Empire State Meat Goat Producers Association

WWW.ESMGPA.ORG

*Maintains Northeast Small Ruminant Marketing listserv
for ads.*

SheepGoatMarketing.info

WWW.SHEEPGOATMARKETING.INFO

NYS 4-H Youth Development, Goat Programs

WWW.ANSCI.CORNELL.EDU/4H/GOATS/INDEX.HTML

Cornell Cooperative Extension of Albany County

50 West St.
Ballston Spa, NY 12020
518-885-8995

WWW.CCESARATOGA.ORG

SARATOGA@CORNELL.EDU

Florida Agricultural and Mechanical University

University Small Ruminant Program

WWW.FAMU.EDU/INDEX.CFM?GOATS&MASTERGOATPROGRAM

Florida A & M University Small Ruminant Program

WWW.FAMU.EDU/CESTA/MAIN/INDEX.CFM/COOPERATIVE-
EXTENSION-PROGRAM/AGRICULTURE/SMALL-RUMINANT/
ABOUT-THE-SMALL-RUMINANT-PROGRAM/

Fort Valley State University

College of Agriculture
Home Economics and Allied Programs
Fort Valley, GA
478-825-6344

WWW.AG.FVSU.EDU

Kannan Govind, director, GOVINDAK@FVSU.EDU

Growing New Farmers

275 Jackson St.
Belchertown, MA 01007
413-323-4531

WWW.GROWINGNEWFARMERS.ORG

INFO@GROWINGNEWFARMERS.ORG

Resource for farmers in the Northeast.

Langston University E (Kika) de la Garza Institute for Goat Research

PO Box 730
Langston, OK 73050
405-466-3836

WWW.LURESEXT.EDU/GOATS/INDEX.HTM

Newsletter, Goat Field Day, online resources.

Laval University

Québec, Canada

WWW.OVINS.FSAA.ULAVAL.CA

Research topics and publications on sheep, in French.

Maryland Small Ruminant Page

WWW.SHEEPANDGOAT.COM

Meat Goat Performance Test blog

Maryland Cooperative Extension
WWW.MDGOATTEST.BLOGSPOT.COM

Ministère de l'Agriculture, Pêcheries et de

l'Alimentation du Québec (MAPAQ)

460 boulevard Louis-Frédéric
Nicolet, QB, Canada J3T 1Y2
819-293-8501 ext. 219, fax 819-293-8446
WWW.MAPAQ.GOUV.QC.CA/CENTREDUQUEBEC
WWW.AGRIRESEAU.QC.CA

Michel Lemelin, advisor on sheep and goat
production, central region of Québec
MICHEL.LEMELIN@MAPAQ.GOUV.QC.CA

New England Food Entrepreneurs

WWW.UMASS.EDU/NEFE/HOW_TO/

*Online support for starting and running a food business,
offered by the New England Extension Food Safety Consor-
tium.*

New England Land Link

WWW.SMALLFARM.ORG/NELL/INDEX.HTM
LANDLINK@SMALLFARM.ORG

*A program to help farmers and landholders locate and trans-
fer farms in New England.*

New Hampshire Beginning Farmers

WWW.BEGINNERFARMERS.ORG/

A farmer-to-farmer network with the goals of connecting farmers and the community, sharing ideas and information, and accessing technical assistance and agricultural education.

Northeast Center for Food Entrepreneurship

WWW.NYSAES.CORNELL.EDU/NECFE/INDEX.HTML

Northeast Sustainable Agriculture Research and Education (NE SARE)

University of Vermont

655 Spear St.

Burlington, VT 05405

802-656-0471

WWW.UVM.EDU/~NESARE, NESARE@UVM.EDU

Applications and current information about NE SARE farmer, grower, and other grants.

Northern New England AgrAbility Project

WWW.UVM.EDU/~FARMFAM/?PAGE=NAGRABILITY.HTM

WWW.AGRABILITYPROJECT.ORG

Federally funded program that provides education and assistance to farmers, ranchers, and farm workers with disabilities who are engaged in production agriculture.

Oklahoma State University Quicken Newsletter (OSU Quick Tips)

529 Agricultural Hall

Stillwater, OK 74078

405-744-9831

WWW.AGECON.OKSTATE.EDU/QUICKEN/

Da-mona Doye

DAMONA.DOYE@OKSTATE.EDU

Pennsylvania Association for Sustainable Agriculture (PASA)

141 West Main St., PO Box 419

Milheim, PA 16854

814-349-9856

WWW.PASAFARMING.ORG

Allison Shauger, director of educational outreach

ALLISON@PASAFARMING.ORG

Small Ruminant Nutrition System

WWW.NUTRITIONMODELS.TAMU.EDU/SRNS.HTM

Free diet balancing software from a collaboration among Cornell University, Texas A&M University, and the University of Sassari, Italy.

Regional Farm & Food Project

PO Box 8628

Albany, NY 12208

518-271-0744

WWW.FARMANDFOOD.ORG

Gianni Ortiz, executive director

GIANNI@GIANNIORTIZ.COM

Newsletter; workshops for farmers to develop and market food (including cheese).

University of Maine Cooperative Extension/Maine Department of Agriculture

WWW.UVMEXT.MAINE.EDU/

Goat and sheep dairy, meat, and fiber.

Dick Brzozowski, Cumberland County educator

207-780-4205, 800-287-1471

RBRZ@UMEXT.MAINE.EDU

Donna Coffin, Piscataquis County educator

207-564-3301, 800-287-1491

DCOFFIN@UMEXT.MAINE.EDU

Anne Lichtenwalner

Maine Veterinary Diagnostic Lab

207-581-2789

ALICHT@UMEXT.MAINE.EDU

University of New Hampshire Cooperative Extension

WWW.EXTENSION.UNH.EDU

John Porter, dairy specialist (including goats)

603-225-5505 ext. 322

JOHN.PORTER@UNH.EDU

Tina Savage, Extension educator, Ag Resource and Environmental Stewardship

603-447-3834

TINA.SAVAGE@UNH.EDU

University of Wisconsin-Madison

WWW.UWEX.EDU/CES/ANIMALSCIENCE/SHEEP/

Sheep management website with dairy sheep symposium proceedings.

University of Wisconsin-Madison, Animal Science UW-Extension Ag Research Station

W6646 Hwy. 70

Spooner, WI 54801

WWW.UWEX.EDU/CES/ANIMALSCIENCE/SHEEP/

Claire Mikolayunas Sandrock, small ruminant specialist

MIKOLAYUNAS@WISC.EDU

David Thomas, Sheep Genetics & Management
(including dairy sheep)
608-263-4306
DLTHOMAS@WISC.EDU

Vermont Institute for Artisan Cheese

Jody Farnham, 802-656-8300
WWW.UVM.EDU / VIAC
JFARNHAM@UVM.EDU

Western Maryland Research and Education Center

18330 Keedysville Rd.
Keedysville, MD 21756
301-432-2767 ext. 343, fax 301-432-4089
WWW.EXTENSION.UMD.EDU / LOCAL / WMREC /
Susan Schoenian, sheep and goat specialist
SSCHOEN@UMD.EDU

UVM and UVM Extension Agricultural Programs and Services

Across the Fence

106 High Point Center, Suite 300
Colchester, VT 05446
Will Mikell, producer, 802-656-4269
WILL.MIKELL@UVM.EDU
WWW.UVM.EDU / ~UVMEXT / ATF / DEFAULT.PHP
Weekly noontime television program on farm and garden topics.

Agricultural & Environmental Testing Lab

UVM, 219 Hills Bldg., Burlington, VT 05405
UVM.EDU / PSS / AG-TESTING /
AGTESTING@UVM.EDU
802-656-3030, 800-244-6402
Soil and feed analysis at UVM.

Farm Viability and Enhancement Program

WWW.VHCB.ORG / VIABILITY.HTML
MARK.CANELLA@UVM.EDU
802-223-2389

Northern New England AgrAbility Project

WWW.UVM.EDU / ~FARMFAM / ?PAGE=NAGRABILITY.HTM
WWW.AGRABILITYPROJECT.ORG
Philip Wolf
802-751-8307, 800-545-8920
PHILIP.WOLF@UVM.EDU
Federally funded program that provides education and assistance to farmers, ranchers, and farm workers with disabilities who are engaged in production agriculture and want to continue farming or ranching.

Rural & Agricultural VocRehab

WWW.UVM.EDU / ~FARMFAM /
802-751-8307, 800-545-8920
Provides support for health evaluation, counseling, and assistance in job maintenance or placement for people with disabilities who reside in rural parts of Vermont and/or are employed in some form of agriculture.

State Administrative Office

19 Roosevelt Highway
Colchester, VT 05446
WWW.UVM.EDU / EXTENSION /
Douglas Lantagne, dean and director of Extension
802-656-2990
DOUG.LANTAGNE@UVM.EDU

State 4-H office

WWW.UVM.EDU / EXTENSION / PROGRAMS / 4H / DEFAULT.PHP
Sarah Kleinman, Vermont 4-H outreach education coordinator
802-656-0311, 866-800-9944
SARAH.KLEINMAN@UVM.EDU
Wendy Sorrell, 4-H livestock educator
802-656-5418, 866-800-9944
WENDY.SORRELL@UVM.EDU

UVM Center for Sustainable Agriculture

106 High Point Center, Suite 300
Colchester, VT 05446
802-656-5459
WWW.UVM.EDU / SUSTAINABLEAGRICULTURE
Linda Berlin, Director
802-656-0669
LINDA.BERLIN@UVM.EDU
Jennifer Colby, Vermont Pasture Network outreach coordinator
802-656-0858
JENNIFER.COLBY@UVM.EDU

State of Vermont/USDA Agencies and Programs

WWW.VERMONT.GOV

Natural Resources Conservation Service

356 Mountain View Dr., Suite 105
Colchester, VT 05446
802-951-6795

Northeast Sustainable Agriculture Research and Education (SARE)

655 Spear St.
Burlington, VT 05405-0107
802-656-0471, fax 802-656-0500

Rural Development Office

City Center, 89 Main St., 3rd floor
Montpelier, VT 05602
802-828-6000, 802-223-6365, fax 802-828-6018
WWW.RURDEV.USDA.GOV

Vermont Farm Service Agency (FSA)

356 Mountain View Dr., Suite 104
Colchester, VT 05446
802-658-2803, fax 802-660-0953
WWW.FSA.USDA.GOV / VT /
U.S. Department of Agriculture serving Vermont.

Veterinary Services

Dr. William G. Smith (APHIS area veterinarian in charge — CT, MA, NH, RI, VT)
New England Area office in Sutton, MA
508-363-3390 (M–F 8:00–4:30)
VSM@APHIS.USDA.GOV, WWW.APHIS.USDA.GOV / ANIMAL_HEALTH / AREA_OFFICES / STATES / NEWENGLAND_INFO.HTML

Vermont Agency of Agriculture, Food and Markets

WWW.VERMONTAGRICULTURE.COM
116 State St., Drawer 20
Montpelier, VT 05620-2901
802-828-2416

Chuck Ross, secretary of agriculture
802-828-2430
CHUCK.ROSS@STATE.VT.US

Diane Bothfeld, deputy secretary of agriculture
802-828-3835
DIANE.BOTHFELD@STATE.VT.US

Kristin Haas, state veterinarian
802-828-2426
KRISTIN.HAAS@STATE.VT.US

Laurel Junkins, dairy systems coordinator
802-828-2416
LAUREL.JUNKINS@STATE.VT.US
Milk quality and milking systems.

Dan Scruton, dairy and energy chief, Dairy Division
802-828-3836

DAN.SCRUTON@STATE.VT.US
Small ruminant milking systems.

Agriview (agricultural newsletter)
WWW.STATE.VT.US / AGRIC / AGRIVIEWONLINE.HTM
802-828-2416

Kelly Loftus, editor, public information officer
802-828-3829
KELLY.LOFTUS@STATE.VT.US

Vermont Business Planning, Training, and Lending Programs

Micro Business Development Program

PO Box 437
Putney, VT 05346
802-387-5029
WWW.VTMICROBUSINESS.ORG

NOFA Vermont Revolving Loan Fund

802-434-4122
WWW.NOFAVT.ORG / PROGRAMS / FARM-FINANCIAL-RESOURCES / REVOLVING-LOAN-FUND
INFO@NOFAVT.ORG
Applications online or call office. For technical assistance with applications and business plans.

Northeast Organic Farming Association of Vermont

WWW.NOFAVT.ORG
Enid Wonnacott
802-434-4122

Vermont Community Loan Fund (VCLF)

15 State St.
PO Box 827
Montpelier, VT 05602
802-223-1448
WWW.VCLF.ORG, VCLF@VCLF.ORG

Vermont Economic Development Authority (VEDA)

58 East State St., Suite 5
Montpelier, VT 05602
802-828-5627
WWW.VEDA.ORG, INFO@VEDA.ORG

Vermont Farm Viability Enhancement Program

Vermont Housing and Conservation Board

149 State St.
Montpelier, VT 05602
WWW.VHCB.ORG / VIABILITY.HTML
Ela Chapin, program director
802-828-2117
ELA@VHCB.ORG

Provides a team approach for existing farmers to assess their enterprises with a business plan for a new idea or expansion of current production. Includes funds for consulting, and participants are eligible to apply for funds for implementation pertaining to their written business plan. Participating coordinators to contact:

Intervale Foundation
WWW.INTERVALE.ORG
Travis Marcotte
802-660-0440 ext. 107

UVM Extension

Mark Cannella
802-223-2386
MARK.CANNELLA@UVM.EDU

Dennis Kauppila
802-751-8307 ext. 359
DENNIS.KAUPPILA@UVM.EDU

Vermont Department of Economic Development

WWW.THINKVERMONT.COM
An online source providing sources of information for starting a business.

Vermont Food Venture Center

140 Junction Road
PO Box 422
Hardwick, VT 05843
802-472-5362
GEORGE@HARDWICKAGRICULTURE.ORG
WWW.VERMONTFOODVENTURECENTER.ORG

Vermont New Farmer Project

UVM Center for Sustainable Agriculture
802-656-5459
WWW.UVM.EDU/NEWFARMER
NEWFARMER@UVM.EDU
A collaboration of organizations working to assist new farmers. Offers a comprehensive guide of resources for starting and funding a farm enterprise.

Vermont Small Business Development Center

PO Box 188
Randolph Center, VT 05061
802-728-9101, 800-464-SBDC
WWW.VTSBDC.ORG

Vermont Women's Business Center

8 South Main St.
Barre, VT 05641
802-479-9813, 877-524-1998
WWW.VWBC.ORG, VWBC@CVAC.ORG

Womens' Agricultural Network (WAgN)

UVM Extension, Berlin Office
Mary Peabody, Director
617 Comstock Road
Berlin, VT 05602
802-223-2389
WAGN@UVM.EDU
WWW.UVM.EDU/WAGN/

Women's Small Business Program (Mercy Connections)

346 Shelburne Rd.
Burlington, VT 05401
802-846-7063
WWW.MERCYCONNECTIONS.ORG/PHP/WSBP.PHP
Lorna Lyons, program coordinator
LLYONS@MERCYCONNECTIONS.ORG

Vermont Agricultural Organizations and Member Associations

Alpaca Breeders of Vermont,

WWW.ALPACABREEDERSOFVERMONT.COM
CONTACT@ALPACABREEDERSOFVERMONT.COM

Composting Association of Vermont

contact Tom Gilbert, Highfields Institute
802-472-5138
HIGHFIELDSEFW@VTLINK.NET

Fancy Meats from Vermont

Lydia Ratcliff
2604 East Hill Rd.
Andover, VT 05143
802-875-3159
WWW.FANCYMEATSFROMVERMONT.COM
Meat marketing group for lamb, kid, and other products.

Highfields Institute

Tom Gilbert, program director
802-472-5138
WWW.HIGHFIELDSINSTITUTE.ORG
HIGHFIELDSEFW@VTLINK.NET
On-farm composting research and education to preserve farming and the environment.

Northeast Fiber Arts Center

7351 Williston Rd.,
So. Burlington, VT 05403
802-288-8081
WWW.NORTHEASTFIBERARTS.COM
NFAC@TOGETHER.NET

Northeast Organic Farming Association of Vermont (NOFA-VT)

PO Box 697
Richmond, VT 05477
802-434-4122
WWW.NOFAVT.ORG, INFO@NOFAVT.ORG

Vermont Organic Farmers
802-434-3821
VOF@NOFAVT.ORG

Northern Vermont Farm-Sitter Network

WWW.GROUPS.YAHOO.COM/ GROUP / FARM-SIT /

Rural Vermont

15 Barre St., Suite 2
Montpelier, VT 05602-3504
802-223-7222
WWW.RURALVERMONT.ORG
Education and advocacy organization for a sustainable economic farm policy.

Southern Vermont Dairy Goat Association

WWW.VTGOATS.ORG, INFO@VTGOATS.ORG

Vermont Cheese Council

866-261-8595
WWW.VTCHEESE.COM
INFO@VTCHEESE.COM
Newsletter, membership, marketing.

Vermont Dairy Herd Improvement Association

226 Holiday Dr., Suite 3
White River Junction, VT 05001
800-639-8067
WWW.VTDHIA.ORG
VTDHIA@VTDHIA.ORG
Provides milk testing, analysis, and record summaries for dairy cow, goat, sheep, and buffalo farms.

Brett Denny, general manager
802-233-8662
BDENNY@VTDHIA.ORG

Cindy Mayette, administrative assistant
800-639-8067
VTDHIA@VTDHIA.ORG

Vermont Dairy Industry Association

140 Federal St.
St. Albans, VT 05478
802-524-6581, 800-559-0343
WWW.STALBANSCOOPERATIVE.COM
STALBANSCOOP@STALBANSCOOPERATIVE.COM

Vermont Feed Dealers and Manufacturers Association

c/o Poulin Grain Co.
24 Railroad Square
Newport, VT 05855
Mike Tetreault, president
802-334-6731

Art Whitman, vice president
PO Box 123
No. Bennington, VT 05257
802-442-2851

Vermont Fiberworks

28 Norton Rd.
Worcester, VT
Kimberly Hagen-Dillon
802-229-4096
KHAGEN@SOVER.NET

Vermont Food Bank,

PO Box 254
So. Barre, VT 05670
shipping address: 33 Parker Rd.
Wilson Industrial Park
Barre, VT 05641
802-476-3341
WWW.VTFOODBANK.ORG
KCROWNINGSHIELD@SECONDHARVEST.ORG
Farmers can donate extra meat, cheese, vegetables, and eggs.

Vermont Fresh Network

PO Box 895
Richmond, VT 05477
802-434-2000
WWW.VERMONTFRESH.NET
INFO@VERMONTFRESH.NET
Meghan Sheradin, executive director
802-989-0534
MEGHAN@VERMONTFRESH.NET
Creates partnerships between farmers and chefs.

Vermont Grass Farmers' Association

PO Box 142
Randolph Center, VT 05061
WWW.UVM.EDU / ~PASTURE / ?PAGE=VGFA.HTML
Bekah Murchinson, president
Brattleboro, VT
contact: Jennifer Colby
802-656-0858
JENNIFER.COLBY@UVM.EDU

Vermont Quality Meats

28 Allen St.
Rutland, VT 05701
802-747-5950
WWW.VTQUALITYMEATS.COM
CONTACT@VTQUALITYMEATS.COM
Meat marketing farmers' cooperative.

Vermont Sheep and Goat Association

INFO@VTSHEEPANDGOAT.ORG
WWW.VTSHEEPANDGOAT.ORG
Members enjoy a popular listserv, website, educational events, VT Sheep and Wool Festival, and more.

Vermont Veterinary Medical Association

88 Beech St.
Essex Junction, VT 05452
802-878-6888, fax 802-878-2871
WWW.VTVETS.ORG
WWW.INFOVTVETS.ORG
Kathryn Finnie, executive director
KATHY@VTVETS.ORG

Goat Milk Markets/Marketing in Vermont

Vermont Butter & Cheese Creamery

PO Box 95
40 Pitman Road
Websterville, VT 05678
800-884-6287, 802-479-9371
WWW.VERMONTCREAMERY.COM
INFO@VERMONTCREAMERY.COM

Vermont Cheese Council

Rachel Fritz Schaal
131 West Parish Rd.
Westminster West, VT 05346
866-261-8595
WWW.VTCHEESE.COM
INFO@VTCHEESE.COM

Regional Livestock and Fiber Marketing

Cornell University Northeast Sheep & Goat Marketing Project

WWW.SHEEPGOATMARKETING.INFO
Great resource for identifying buyers and sales for livestock.
Tatiana Stanton
TLS7@CORNELL.EDU
Contact Tatiana to be added to small ruminant marketing list serve.

Danville Auction

15780 Body Rd.
Danville, OH 43014
contact: Albert Hershberger
740-599-6607
ANDERSIBO@HOTMAIL.COM
Noted for sales of meat and dairy goats.

Fancy Meats from Vermont

Lydia Ratcliff
2604 East Hill Rd.
Andover, VT 05143
802-875-3159
WWW.FANCYMEATSFROMVERMONT.COM
Meat marketing group for lamb, kid, and other products.

Lonestar Wool and Fur Tannery

807 Massey St.
Smithfield, NC 27577
919-989-2000
WWW.LONESTARFURDRESSING.COM

Maine Department of Agriculture, Division of Market and Production Development

90 Blossom Lane
Augusta, ME 04333-0028
207-287-3491
WWW.MAINE.GOV / AGRICULTURE / MPD / INFORMATION

Northeast Sheep and Goat Genetics Alliance, Inc.

228 Main St.
Jordanville, NY 13361
contact: Jean Walsh, 315-858-6042
WALSHTJ@MVIP.NET
Sheep and goat breeders in the New England states, as well as New York and New Jersey, have banded together to offer the very best semen and live animals to buyers locally, nationally, and worldwide. Sheep standards for "best" include genetically sound animals free of spider syndrome and other inherited problems for which there is a test.

North Hampton Cooperative Auction

Long Plain Rd.
Whatley, MA, 01373
413-665-8774
Goat and sheep auctions on Tuesdays.

USDA Agricultural Marketing Service

WWW.AMS.USDA.GOV

Vermont Quality Meats

28 Allen St.
Rutland, VT 05701
802-747-5950
WWW.VTQUALITYMEATS.COM
CONTACT@VTQUALITYMEATS.COM
Meat marketing farmers' cooperative.

Apprenticeship/Internship Programs

Maine Organic Farmers and Gardeners Association

294 Crosby Brook Rd.
PO Box 170
Unity, Maine 04988
207-568-4142
WWW.MOFGA.ORG

Northeast Organic Farming Association of Vermont (NOFA-VT)

PO Box 697
Richmond, VT 05477
802-434-4122
WWW.NOFAVT.ORG, INFO@NOFAVT.ORG

Sustainable Farming Internships and Apprenticeships National Sustainable Agriculture Information Service

800-346-9140
WWW.ATTRAINTEENSHIPS.NCAT.ORG/

University of Vermont Department of Animal Science

107 Terrill Hall
Burlington, VT 05405-0155
WWW.ASCI.UVM.EDU/INTERN/
Fran Kinghorn, internship coordinator, 802-656-0676
FRANCES.KINGHORN@UVM.EDU

University of Vermont Department of Plant and Soil Science

Internship program coordinators:
Yolanda Chen
802-656-2627
YOLANDA.CHEN@UVM.EDU
Mark Starrett
802-656-0467
MARK.STARRETT@UVM.EDU

Vermont Technical College, Agriculture Institute

Chris Dutton, DVM, professor of dairy farm
management technology
802-728-1793
CDUTTON@VTC.EDU
WWW.AGCAREERS.COM
WWW.BACKDOORJOBS.COM

Cheese Products Consultants

Dairy Foods Consulting

Peter Dixon
131 West Parish Rd.
Westminster West, VT 05346
802-387-4041
WWW.DAIRYFOODSCONSULTING.COM
PETERHICKSDIXON@GMAIL.COM

Glengarry Cheesemaking and Dairy Supplies

PO Box 92
Massena, NY 13662
888-816-0903
WWW.GLENGARRYCHEESEMAKING.ON.CA
INFO@GLENGARRYCHEESEMAKING.ON.CA

Keith Kirchner Dairy Processing Plant Design & Set-up

4043 Creek Rd.
Irasburg, VT 05845
802-755-6349
KIRCHNER@KINGCON.COM
Business and operational consultation.

Vermont Institute for Artisan Cheese

Jody Farnham
802-656-8300
WWW.UVM.EDU/VIAC, JFARNHAM@UVM.EDU

Cheesemaking Classes

Ag-Innovations

Larry and Linda Faillace
Three Shepherds Cheese
108 Roxbury Mountain Rd.
Warren, VT 05674
802-496-4559
WWW.THREESHEPERDS-CHEESE.COM
LOCALFOOD@MSN.COM

Glengarry Cheesemaking & Dairy Supplies

Margaret Morris
PO Box 92
Massena, NY 13662
888-816-0903
WWW.GLENGARRYCHEESEMAKING.ON.CA
INFO@GLENGARRYCHEESEMAKING.ON.CA

Lazy Lady Farm

Laini Fondiller
 973 Snyderbrook Rd.
 Westfield, VT 05874
 802-744-6365
 LAINI@SOVER.NET

New England Cheesemaking Supply Company

PO Box 85
 Ashfield, MA 01330
 413-628-3808, fax 413-628-4061
 WWW.CHEESEMAKING.COM, INFO@CHEESEMAKING.COM

Regional Farm & Food Project

PO Box 8628
 Albany, NY 12208
 518-271-0744
 WWW.FARMANDFOOD.ORG
 Gianni Ortiz, executive director
 GIANNI@GIANNIORTIZ.COM

The Training Center for Farmstead Cheesemaking

Peter Dixon
 131 West Parish Rd.
 Westminster West, VT 05346
 802-387-4041
 WWW.DAIRYFOODSCONSULTING.COM
 DIXONPETER@MAC.COM

Vermont Institute for Artisan Cheese

Jody Farnham, 802-656-8300
 WWW.UVM.EDU/VIAC
 JFARNHAM@UVM.EDU

Woodcock Farm

Mark and Gari Fischer
 PO Box 21
 Weston, VT 05161
 802-824-6135
 WOODCOCK@VERIZON.NET

**Equipment and Services,
Regional, National and International****Alliance Pastorale**

33-0-5-49833049 English
 33-0-5-49833030 French
 WWW.ALLIANCEPASTORALE.COM
 AP@ALLIANCEPASTORALE.FR.
A French organization with international services for small farms; it has a catalog that includes cheese molds not found in this country, as well as livestock management items.

BIO-Genics, Ltd.

1538 Highway 28
 Salmon, ID 83467
 208-756-6500
 WWW.BIOGENICSLTD.COM/INDEX.HTML
 CONTACTUS@BIOGENICSLTD.COM
Artificial insemination, equipment, goat semen, clinics, collection.

Buck Bank

2344 Butte Falls Hwy.
 Eagle Point, OR 97524
 541-826-2729
 WWW.THEBUCKBANK.COM/HOME.HTM
 DHEANEY@JEFFNET.ORG
Semen collection and sales, AI equipment, video, and nitrogen tanks.

Caprine Supply

800-646-7736
 WWW.CAPRINESUPPLY.COM

DeLaval dealers

WWW.DELAVAL-US.COM/SALES_CONTACTS/USA.HTM

New Hampshire:

RN Johnson Inc.
 PO Box 448, Main St.
 Walpole, NH
 603-756-3321

Vermont:

Lyon's Dairy Sales & Service
 2409 U.S. Rt. 5
 Derby, VT 05829
 802-766-5362

Premier Dairy Service, Inc.
 54 Creek Rd., Suite B
 Middlebury, VT 05753
 802-388-0043

Premier Dairy Service, Inc.
 20 Beaugard Dr.
 St. Albans, VT 05478
 802-524-1852

Hamby Dairy Supplies

800-306-8937
 WWW.HAMBYDAIRYSUPPLY.COM

Hoegger Supply Company

800-221-4628
 WWW.HOEGGERGOETSUPPLY.COM

Micro Dairy Designs, LLC

13339 Smithburg Pike
Smithburg, MD 21783
Frank Kipe
301-824-3689

MICRODAIRYDESIGNS.COM
FRANK@MICRODAIRYDESIGNS.COM

*Affordable small-scale milk processing equipment approved
for use in PA, MD, VT, ME, and TX.*

**Milking equipment manufacturers contact listing
worldwide**

WWW.ICBA-ISRAEL.COM/BOOKMARKS/EQUIPMENT.HTM

Northwestern Tools, Inc., JayBee Precision, Inc.

3130 Valleywood Drive
Dayton, OH 45429
800-236-3956

WWW.JAYBEEPRECISION.COM

Small vat pasteurizer.

NuPulse, Inc.

490 N. Burr Oak Ave.
Oregon, WI 53575
800-223-6878

WWW.NUPULSE.COM

NUPULSE@NUPULSE.COM

Gascoigne Melotte equipment supplier.

Pladot Mini Dairy

PLADOT Ein Harod Meuhad, 18965, ISRAEL
from USA 888-521-3030, fax 972-4-653-1641

WWW.PLADOT.CO.IL

PLADOT@PLADOT.COM

Premier Fencing

2031 300th Street
Washington, Iowa 52353
319-653-6304, 800-346-7992

WWW.PREMIER1SUPPLIES.COM

Westfalia Dairy Systems

WWW.WESTFALIA.COM/US/EN.

877-WS-DAIRY (877-973-2479)

Make sheep and goat milking equipment.

**National and International Associations
and Groups****Alpines International Club**

970-876-2738

WWW.ALPINESINTERNATIONALCLUB.COM

MAMMKEY@SOPRIS.NET

Tina Antes, secretary-treasurer

American Boer Goat Association

1207 S. Bryant Blvd., Suite C
San Angelo, TX 76903
325-486-2242

WWW.ABGA.ORG

INFO@ABGA.ORG

American Cheese Society

455 S. Fourth St., Suite 650
Louisville, KY 40202
502-583-3783

WWW.CHEESESOCIETY.ORG

ACS@HGTRS.COM

American Dairy Goat Association

209 West Main St., PO Box 865
Spindale, NC 28160
828-286-3801, fax 828-287-0476

WWW.ADGA.ORG

INFO@ADGA.ORG

American Goat Society

735 Oakridge Lane
Pipe Creek, TX 78063
830-535-4247

WWW.AMERICANGOATSOCIETY.COM

Amy Kowalik, office manager

AGSOFFICE@EARTHLINK.NET

American LaMancha Club

WWW.LAMANCHAS.COM

American Nigerian Dwarf Association

1510 Bird Rd.
Independence, KY 41051
859-356-2478

WWW.ANDDA.ORG

INFO@ANDDA.ORG

American Sheep and Goat Center

Box 646
Rockland, ME 04841
800-971-1373, 202-350-9065

WWW.SHEEPANDGOATSUSA.ORG / INFO@ASGCUSA.ORG

*Successor to the National Sheep Industry Improvement
Center.*

American Sheep Industry Association

9785 Maroon Circle, Suite 360
Englewood, CO 80112
303-771-3500, fax 303-711-8200

WWW.SHEEPUSA.ORG

INFO@SHEEPUSA.ORG

Australian Cashmere Growers Association

WWW.ACGA.ORG.AU

Boer Goat Breeders of Maine

WWW.BOERGOATBREEDERSOFMAINE.ORG

Pat Polley, president
207-582-8665

British Goat Society

WWW.ALLGOATS.COM

SECRETARY@ALLGOATS.COM

British Sheep Dairy Association (BSDA)

WWW.BUSINESS-SUPPORT-WALES.GOV

Canadian Sheep Federation

130 Malcom Rd.
Guelph, ON N1K 1B1
888-684-7739, 519-824-6018

WWW.CANSHEEP.CA

CANSHEEP@CANSHEEP.CA

Dairy Practices Council

19 Titus Court
Richboro, PA 18954

WWW.DAIRYPC.ORG

DAIRYPC@DAIRYPC.ORG

phone / fax 215-355-5133

Publishes educational guidelines for large and small ruminant dairy farmers.

Dairy Sheep Association of North America

WWW.DSANA.ORG

INFO@DSANA.ORG.

Sponsor of the Great Lakes Dairy Sheep Symposium.

Dairy Sheep Listserv

WWW.GROUPS.YAHOO.COM / GROUP / DAIRYSHEEP

To discuss dairy sheep topics.

Empire State Meat Goat Producers' Association

WWW.ESMGPA.ORG

Brett Lindsay, president

BSBBLINDSAY@TWCNY.RR.COM

Heifer International

1 World Ave.
Little Rock, AR 72203
888-548-6437

WWW.HEIFER.ORG

INFO@HEIFER.ORG

International Goat Association

WWW.IGA-GOATWORLD.ORG /

International Nubian Breeders Association

5124 FM 1940

Franklin, TX 77856

membership: Caroline Lawson, secretary-treasurer
979-828-4158

WWW.I-N-B-A.ORG

SECRETARY@I-N-B-A.ORG

Kentucky Goat Producers Association / Kentucky Sheep and Wood Producers' Association

1009 Twilight Trail, Suite 107

Frankfort, KY 40601

502-352-2434

WWW.KYSHEEPANDGOAT.ORG

Ray Bowman, executive director

Maine Cheese Guild

c/o State of Maine Cheese Co.

461 Commercial St.

Rockport, ME 04846

207-775-4818 (please leave message)

WWW.MAINECHEESEGUILD.ORG

Maine Sheep Breeders Association

207-838-5383

WWW.MAINESHEEPBREEDERS.ORG

INFO@MAINE-ANTIQUES.COM

Philip Webster, president

207-892-2161

National Livestock Producers Association Sheep and Goat Fund (NLPA)

13570 Meadowgrass Dr. Suite 201

Colorado Springs, CO 80921

719-538-8843, 800-237-7193

WWW.NLPA.ORG, NLPA@NLPA.ORG

WWW.SHEEPANDGOAT.COM.

Loans and loan guarantees for public, private, or cooperative organizations for production and marketing initiatives.

National Saanen Breeders Association

PO Box 916

Santa, NM 87576

WWW.NATIONALSAAENBREEDERS.COM

Lisa Shepard, secretary-treasurer

505-689-1371

SHEPARD@THEGRID.NET

National Toggenburg Club

1156 E. 4100 North
Buhl, ID 83316
208-543-8824,
WWW.NATIONALTOGGCLUB.ORG
GOATTOIT@YAHOO.COM
Cathy Pindell, secretary-treasurer

New England Border Collie Rescue, Inc.

WWW.NEBCR.ORG
SHPPDOG@GIS.NET
INFO@NEBCR.ORG
In Vermont, contact Kathy Chittenden
SUGARBUSH761@AOL.COM
Finds border collies new homes.

**New England Livestock Alliance (NELA) /
Heritage Breeds Conservancy, Inc.**

PO Box 20
Richmond, MA 01254
WWW.NEHBC.ORG
NEHBCINFO@NEHBC.ORG

New England Veterinary Medical Association

WWW.NEVMA.ORG

New Hampshire Dairy Goat Association

14 Joe English Rd.
Mt. Vernon, NH 03057
603-673-8426
EXTENSION.UNH.EDU / AGRIC / AGDLEP / GOATS.HTML

**New York State Farmstead and Artisan Cheese
Makers Guild**

9626 County Highway 21
Franklin, NY 13775
607-829-8852
WWW.NYFARMCHEESE.ORG
INFO@NYFARMCHEESE.ORG

New York State Dairy Goat Breeders' Association, Inc.

Terri Coleman
4376 Italy Hill Rd.
Branchport, NY 14418

Northeast Caprine Semen Cooperative

Suzanne Veilleux
190 Drinkwater Rd.
Hampton Falls, NH 03844
DUHGOATMAN.TRIPOD.COM / SEMEN.HTML

Oberhasli Breeders of America

100 Snapper Place
Palatka, FL 32177
WWW.OBERHASLI.NET, SECRETARY@OBERHASLI.NET
Elise Shope Anderson, secretary-treasurer

Ontario Dairy Sheep Association

613-395-4491
WWW.ONTARIODAIRYSHEEP.ORG / INDEX.PHP
Larry Kupecz, president, KUPECZ@XPLORNET.COM

Ontario Goat Breeders Association

PO Box 1330
Fenelon Falls, ON, Canada K0M 1N0
866-311-6422
WWW.OGBA.CA

Raw Milk Cheese Maker's Association

WWW.RAWMILKCHEESE.ORG

Rhode Island Dairy Goat Association

WWW.GEOCITIES.COM / RIDGA04 /
Cecile Beauchemin, president
89 Crankas Rd.
Moosup, CT 06354
CBEAUCHEMIN@99MAIN.COM

Texas Department of Agriculture

Wool and Mohair Directory
WWW.AGR.STATE.TX.US

Wisconsin Dairy Artisan Network

WWW.WISCONSINDAIRYARTISAN.COM /

Wisconsin Dairy Goat Association

WWW.WGDA.ORG
Includes publication Dairy Goat Management Best Practices.

Wisconsin Sheep Dairy Cooperative

WWW.SHEEPMILK.BIZ
INFO@SHEEPMILK.BIZ;
Larry Meisegeier, new member information
800-409-7953, ext. 4
RRSF@SHEEPMILK.BIZ
Yves Berger, sales and shipping
800-409-7953 ext. 3
YMBERGER@SHEEPMILK.BIZ

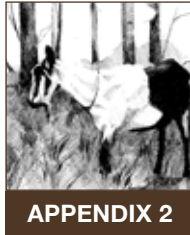

2005 Dairy Goat Budget

Jordan Le Roux, Vermont Butter and Cheese Creamery,
with input from Glenn Rogers

Note from Editor: There are two important points to note as you read this chapter on dairy goat budgets. One is that the figures here were based on prices received and costs expected in the year 2005. Since then, many costs have increased and the prices for fluid milk have increased, as well. (See Chapter 2: To Sell or To Process: That is the Question.) Second, these budgets are based on a completely purchased feed, total confinement farm system. Farmers producing their own forage and grains will put the control of costs into their hands and allow for choices in forage species, soil improvements and increased forage quality. And, if animals are put out to grazing forages and browse forbes and woody plants during the growing season, feed costs have been shown to be lowered by 25% not to mention, less labor for barn cleaning and spreading manure and feeding. Nonetheless, this is a good dissertation on building a realistic budget and can serve as a template for insertion of current figures.

Prior to going into the goat business you should develop a business plan. The business plan includes your farm mission statement, your goals, all resources available to you, marketing and production plans, exit strategies as well as the financial plan. The financial plan consists of the budget, statement of cash flows, and a balance sheet.

The economics emphasis is different depending on whether the dairy goat operation is for a hobby or a commercial dairy. For both, economics is important. As a commercial farm or as a hobby farm raising goats and producing milk can be expensive and profit margins can be small if one does not pay close attention to details. The budget is a tool that allows any farm to develop a sustainable productive and profitable enterprise. In addition to tracking farm income and expenses, you need to determine your economic objectives for family living. Some people wish to derive all family income on the goat operation whereas others have non-farm sources of income for family living costs.

A budget allows producers to evaluate what would be the income at the end of the month or the year. Annual budgets show the incomes and expenses made by farms in one year; money spent and earned can be highlighted either as the total amount for the year, or by goat, or by hundred-weight.

Assumptions

The annual budgets provided here are guidelines and do not represent your future or current income and expenses, because each farm situation is unique. However, existing dairy goat farms may find these

statistics useful for comparison and find ways to improve your operation financially. These budgets have been derived from data from the field and also from published studies.

We realized, after a cost study on six farms, most figures are vary widely. Consequently, we have decided to build a budget based on a combination of field data and published studies. But the data is realistic in terms of herd management (feeding program, veterinary practices, out of season breeding...), prices (feed, veterinary products, milk...), and level of production. These budgets have been based on the prices and the realities in Vermont and the surrounding states in the Northeast United States in 2006.

The different herd sizes presented (100, 200, and 400 goats) are managed by the family, with no hired help except in the case of the 400-goat farm. The different feeding programs that can represent up to 48% of the total expenses allow you to compare your feeding program cost to those presented here. We have assumed the most expensive feed management scenario (all feed is purchased rather than grown on the farm). Consequently, the scenario does not look good, but is close to the Vermont reality.

Calculations were made both per goat and per hundredweight. The calculation per goat is made by averaging all milking, dry and unproductive goats, which are on the farm during the year.* In this report, goats are animals that have had at least one

Table A2.1
Assumptions of livestock numbers and production for different herd sizes

Assumptions	Unit	Herd Size		
GOATS				
Goats (G)	Head	100	200	400
Productive goats (PG) (92%)	Head	92	184	368
Average milk production (1,700 lbs/PG)*	Lb	156,400	312,800	625,600
KIDS				
Prolicity (1.7 kids/PG)	Head	156	312	625
Replacement (25%)	Head	25	50	100
Kids mortality (10%)	Head	15	31	62
Total kids	Head	145	290	580
BUCKS				
Bucks (B) (ratio 1:20 (B/G))	Head	5	10	20
Bucks added (out of season)	Head	5	10	20
Total bucks	Head	10	20	40
CULL ANIMALS				
Cull goats (25%)	Head	25	50	100
Cull buck (32%)	Head	4	7	13
Kids sold	Head	116	230	460

* Average daily milk production of 5.6 pounds for a goat with a lactation of 300 days or 6.5 pounds per day for a 260-day lactation length.

kid (meaning one lactation) but we have assumed that 8% of the goats fail to be bred and are not productive. (See Table A2.1)

Three scenarios have been created in order to show the figures for a commercial dairy goat farm. The assumptions are the same for the three herd sizes. The data used for the milk contents (protein and butterfat) and quality are the 2005 data from dairy goat farms that shipping milk to Vermont Butter and Cheese Creamery.

Milk Payment System

As a rule, goat milk processing companies generally do not pay for milk by the pound or per hundred pounds of milk (CWT). Typically, goat's milk is used for cheese making, thus, goat's milk is valued based on the solids. Farmers are paid for pounds of protein. Unlike the bovine milk industry, the industry has developed a base and over-order goat milk supply system. This is a type of quota system without governmental involvement. This cheese company uses this process to plan how to fulfill its customers' orders and needs to ascertain some predictability throughout the year in its goat milk supply.

Figure A2.1 is an example to describe this process. In 2006 producers were paid \$11.50 per pound

of protein for all of the milk from October 1 to January 31. This is the "quota" period. At the end of January, the VBCC calculates the average pounds of protein shipped during that period. This average determines the producer's quota until the following Oct. After January, the producer is paid \$11.50 for the quota pounds of milk shipped and \$9.00 for pounds of protein in excess of the quota. The objective for the producer is to produce the same amount of protein all year and be paid the maximum \$11.50 for most of their milk.

If the milk tests at 3.2% protein, this means that there are 3.2 pounds of protein in 100 pounds of milk. Multiply 3.2 by the price of the protein to determine the hundredweight price of the milk.

$$3.2 \times \$11.50 = \$36.80/\text{cwt}$$

$$3.2 \times \$9.00 = \$28.80/\text{cwt}$$

Income

In our scenario, gross income/doe is calculated to be about \$640 with 96% of that as milk income. Milk produced contains an average of 3.31% of protein for the year. Milk protein % is assumed to fluctuate as observed commercially with winter protein production higher than that during the summer.

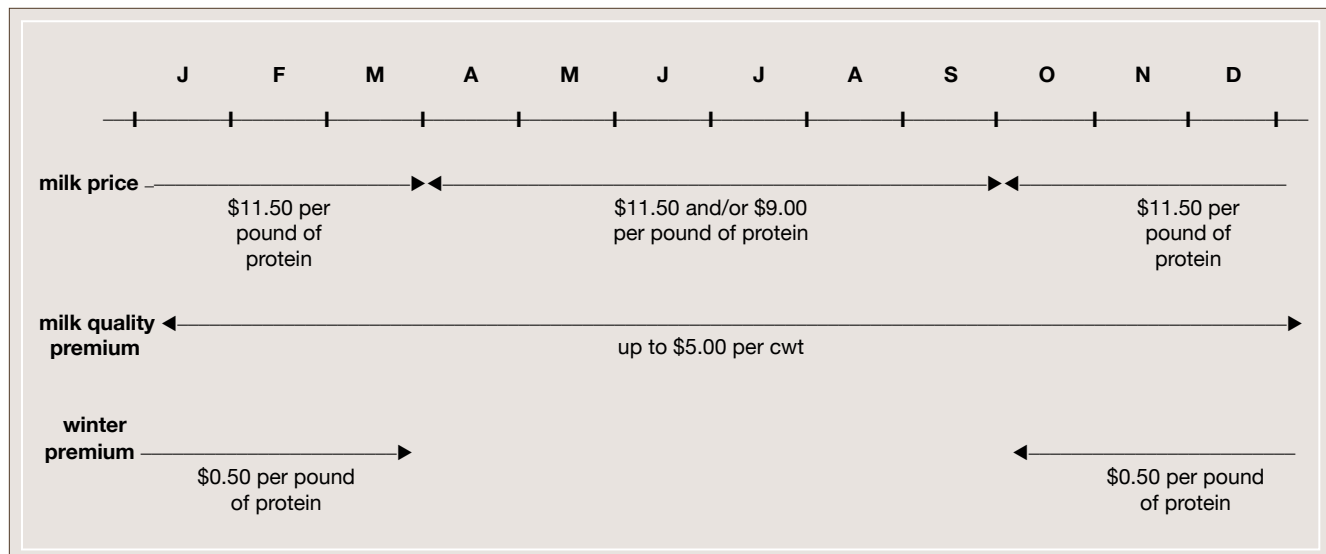

Figure A2.1

Animal sales are not a big factor as there currently is no dairy goat meat market. Therefore it is often difficult to determine a realistic selling price for each category of animals. Thus, a one-week-old animal may sell for \$8, cull goats at \$65 and a buck at \$100. Those numbers do fluctuate throughout the year according to the religious events (eastern holiday, Arabian event, Greek event...) when goat meat is in demand.

Other incomes, that are important for other types of farms, are cheese sales, milk sales directly to a retailer, and government land payments for participating in various programs.

Expenses

There are two different types of costs or expenses associated with a farm budget. They are variable (operating) costs, and fixed costs. The variable costs are the operating inputs that vary with the level of production. The variable costs include purchased feed, bedding, fuel and oil expense, hired labor, veterinary fees and costs that vary depending on the number of goats in the herd. However, the fixed costs are those that do not change proportionally with the level of production. Generally fixed costs include interest, property taxes and insurance, depreciation, repairs, etc.

Feed Costs

Three feeding rations are presented here to provide the reader with the variability of the cost for each situation. Rations include forage and concentrates and the cost per ton of hay varies from \$110 to \$180. In addition, a commercial grain may cost from \$220 to \$250. In this example, we will use a 20% crude protein concentrate at \$235. (The different forage sources will determine the amount of concentrate fed and the energy content. Corn silage provides more energy per pound but is lower in percent crude protein, for example, than haylage or hay.) We also are assuming that no hay is grown on the farm. Note that the main cost is the forage, especially the hay (either grass, alfalfa or both) per goat per year. The feed costs range from 35–50% of all expenses in this cost study.

Generally, it is much more cost effective to provide as much pasture as possible to goats thus cutting down on purchased feed costs. In addition, if your farm is suitable, the authors generally recommend growing as much of your own feed as possible. However, a partial budget is recommended as a tool to determine the profitability of growing vs. purchasing feed.

Hauling Costs

Hauling rates are based on the distance from the cheese plant as well as the density of producers in one area. Typically producers pay \$45 to \$60 per pickup plus \$0.50/cwt in Vermont.

Quality Bonuses

Every two weeks, milk is tested on its quality (Pasteurized Bacteria Count, Raw Bacteria Count and, Somatic Cell Count). Depending on the combination of results, producers can make an additional \$0.25 to \$5.00/cwt for excellent quality milk.

In this case, we will assume that the extra income attributable to superior milk quality is consistent year-round and equals \$4.00 per CWT.

Even though Vermont Butter and Cheese Creamery pays for pounds of protein, if a farmer increases the total quantity of raw milk, the milk check will be bigger. For example: U.S. DHIA averages show that Alpine goats produce 2,083 pounds of milk at 2.9% protein whereas Nubians average 1,496 pounds and 3.6% protein. Although providing less protein per pound of milk, the Alpine ultimately will have produced a higher milk income. (Pounds of protein: Alpine 61 pounds, Nubian 54 pounds.) Thus, in this scenario the Alpine goat with the previous characteristics will provide \$701 income and the Nubian will provide \$621. Therefore, it is important for you to do a budget considering these variables.

Dairy Herd Improvement Association

DHIA cost is calculated by animal number, meters needed, type of analysis and other options. DHIA testing is highly recommended as a tool to determine milk production per goat and for somatic cells, protein and butterfat level. This management tool allows you to follow one goat for its entire producing life and to select animals for future generations.

Vet and Medicine Fees

Most goat operations have a vaccination and health care program consisting of: CD-T vaccination (twice for kids and once for adults), rabies, deworming treatment and mastitis treatment (5% of the herd). Hoof trimming is also included here. A cost of \$13 per goat is assumed in this report.

Taxes

Real estate taxes in Vermont vary by town, by value (appraisal) of the property, by level of household income, and if the farm is enrolled in the Current Use Taxation program. The Vermont Current Use program allows the taxation of real estate based on its current agricultural or forestry use rather than its developmental possibilities. (Contact the Vermont Department of Taxes for specific information.) Other states will have different factors and you should work with your local Extension Agent to determine those costs. Farm real estate taxes may be deducted for income tax purposes, however the house real estate taxes can only be deducted if one is itemizing personal deductions. (Contact your tax accountant for your specific situation). To keep these tax costs low and efficient, utilize the Current Use Tax program where appropriate, keep building costs low and utilize all available land base for agricultural production.

Interest

The interest on the farm loans is deductible as a business expense and is based on the amount of debt (or loans) on land, equipment, livestock, and operating expenses. Interest rates typically go up as the level of risk increases. Land is low risk and thus

has the lowest interest rate, whereas feed (which may have already been fed to the animals) or seed to put into the ground typically has the highest risk and thus the highest interest rate.

Partial Budget

The Partial budget is a useful tool to evaluate the effects of specific practice or production changes on the farm finances. The partial budget only includes the resources that will be affected by changes, unlike a comprehensive budget that includes all aspects of the farm.

The partial budget contains four main parts:

- Added returns
- Reduced costs
- Reduced returns
- Added costs

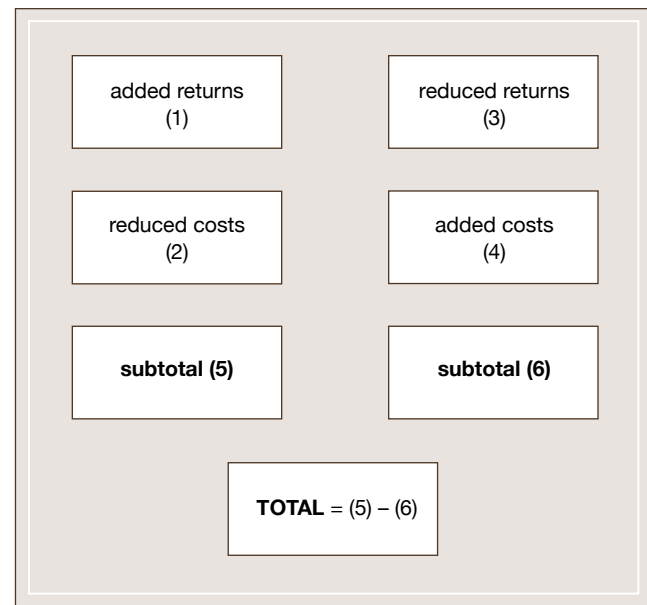

Figure A2.2

Added returns plus reduced costs are positive returns to the budget whereas reduced returns and added costs are negative returns.

Examples may be a farmer's desire to expand the herd from 100 to 125 goats or purchasing or growing feed. In this case added returns would be additional milk and cull goat sales, with reduced costs

being some efficiency gained per goat on variable costs. There may be no reduced returns (unless money is taken from an interest bearing account to purchase goats), but added costs include additional feed, labor, and utilities.

Transitioning from a Dairy Cow to Dairy Goat Business

There are many considerations for someone who wants to switch from a cow to a goat business, including redesigning the buildings to house and milk the goat herd. Remodeling the stalls, the stanchions, the water bowls, and feeding alleys are essential. In addition, goats are much more seasonal breeding animals than cows and specific building designs and protocols are needed to get goats to breed out of season. The milking system for the goat is different from cows, not only from four quarters to two halves but also the pulsator (speed and ratio) as well as vacuum levels are specific to goats. Goats typically produce less than 2,000 pounds each and bulk tanks are much smaller. A 50-cow operation typically translates to 200 goats. Dairy Practices Council Guide #70 (See Resource section) outlines the principles in designing and setting-up a milk room for small ruminants. Although the cow eats much more than a goat, a goat eats daily up to 5.5% of its bodyweight vs. 3.5% for a cow. The feeding ration has to be balanced with the goat's needs just as the ration has to be balanced with the cows requirements.

Capital Investment

Prior to going into the goat operation one needs to understand that there are four areas that you will need to purchase or control. The four areas are: buildings, equipment, livestock, and land. The investment is difficult to approximate because each farm situation is unique. However, the authors have seen investments as high as \$250,000 and as low as \$25,000 for a 100-goat operation. Ingenuity, time, sweat equity, purchasing used equipment, and knowledge are all keys to keeping investment low without sacrificing quality. The amount of capital investment also depends on the family's living

needs, farming objectives, and other factors. Minimally, one medium sized tractor with a bucket and trailer is needed. For those just getting started and needing to purchase a farm, we recommend custom hiring all cropping or purchasing feed for the animals. In addition, renting pasture and cropland may be an option to owning property. However, long-term lease arrangements are generally not available. Land purchase prices may be reduced via purchasing agricultural or forestry land without development rights but it limits options available to the owner. Typically land purchases may be financed over 20–30 years at 5.5–7% interest rates, whereas equipment and livestock purchases may be financed over 5–7 years at 6.5–8% interest rates. Cash flow, repayment capacity, and other positive financial factors generally increase with reduced debt loads. Concentrate on reducing short-term debt (debt due on feed, and other items due within one year) and intermediate-term debt (debt on equipment or livestock due within 1–7 years) as quickly as possible.

Rent

Renting land for crops, pasture and buildings is an option but as stated above long-term lease arrangements are generally not available. Purchasing some land for the buildings, crop and pastureland and then renting land needed as the herd size increases may be an option. However, consultation with your financial advisor is recommended prior to making major capital investments in this area. Cropland for purchase typically costs \$3,000 per acre and pastureland may be \$1,500 to \$2,000/acre.

Buildings can be purchased, rented for a short period of time, or leased with a purchase agreement at the end of the lease. Although the authors do not know of any buildings being rented for goats, building rent for cows may be as little as \$6.00/stall/month or as high as \$12.00/stall/month depending on the condition, equipment and land that may be included. These buildings must be remodeled for goats and perhaps 2 to 3 goats can replace one cow thus rents might be in the \$2.00 to \$6.00 per-stall per-month range for goats.

It is generally much more efficient to rent equipment that is only used sparingly throughout the year. For instance, manure spreading equipment, used just 3 weeks a year, corn planters, and some cropping machinery should be rented. The depreciation, interest, repairs, taxes (if any) and insurance on this equipment outweigh the cost to rent the same or better equipment for the same period of time. On the other hand, equipment used every day should be purchased. Utilize a partial budget as outlined above to determine which equipment to purchase or rent.

Balance Sheet

The balance sheet, or financial statement includes a statement of all the assets and liabilities of the business and individual. In agricultural we break the statement of assets into Current (meaning cash, feed, supplies and other items that have short term values), intermediate (livestock, machinery, other equipment and items that are expected to last more than one but less than 10 years), and long term (buildings and land). Corresponding to this is the

debt associated with those assets. Short-term debt is accounts payable over 30 days old, real estate and income taxes, the portion of the long and intermediate principal debt due this year, and other accounts due within one year. Intermediate term debt is that portion due over one year but less than seven that is leveraged against all livestock and machinery/equipment. Long-term debt is that due for the land and buildings.

Conclusion

Every farm operation and farm family is unique and must be evaluated separately. Thus every farm should develop a business plan prior to going into business. Part of the business plan is the financial management plan that includes an evaluation of all items in this section and also includes a balance sheet.

Business Plan development assistance is available thru the University of Vermont Extension, Vermont Agricultural Viability Program, Small Business Development Corporation, and others. Talk with your local Cooperative Extension Specialist for more information.

Table A2.2
Comparison of itemized budgets for farms with herd sizes of 100, 200 and 400 milking does*

Income/Expense Categories	Farm 1	Farm 2	Farm 3
Number of goats	100	200	400
Pounds of milk sold	156400	312800	625600
Milk price	\$ 35.08	\$ 35.08	\$ 35.08
CASH RECEIPTS			
Milk sales	\$ 54,867	\$ 109,733	\$ 219,466
Bonuses	\$ 6,262	\$ 12,523	\$ 25,046
Goat sales	\$ 1,600	\$ 3,200	\$ 6,400
Kids, bucks, and other livestock	\$ 1,328	\$ 2,540	\$ 4,980
TOTAL CASH RECEIPTS	\$ 64,056	\$ 127,996	\$ 255,893
CASH EXPENSES			
Bedding	\$ 2,500	\$ 4,500	\$ 8,100
Chemicals	\$ 639	\$ 735	\$ 863
DHIA	\$ 2,739	\$ 4,420	\$ 7,752
Ration 1 (corn silage)	\$ 17,496	\$ 34,991	\$ 69,982
Ration 2 (haylage)	\$ 20,620	\$ 41,240	\$ 82,481
Ration 3 (hay)	\$ 22,211	\$ 44,422	\$ 88,845
Feeding kids and replacement	\$ 2,434	\$ 4,869	\$ 9,737
Freight and trucking	\$ 6,008	\$ 6,816	\$ 8,328
Gasoline, fuel and oil	—		
Ration 1	\$ 2,823	\$ 4,234	\$ 5,645
Ration 2–3	\$ 1,717	\$ 2,575	\$ 3,433
Insurance (other than health)	\$ 2,533	\$ 3,286	\$ 7,000
Interest	\$ 6,037	\$ 9,608	\$ 17,916
Labor hired, pension and profit sharing			\$ 26,000
Repairs and maintenance	\$ 3,313	\$ 4,578	\$ 8,311
Taxes	\$ 4,516	\$ 6,240	\$ 10,171
Utilities	\$ 3,000	\$ 6,000	\$ 12,000
Veterinary fees and medicine	\$ 1,300	\$ 2,600	\$ 5,200
Animal purchased	\$ 1,000	\$ 1,750	\$ 3,250
Supplies and miscellaneous	\$ 3,000	\$ 6,000	\$ 12,000
TOTAL CASH EXPENSES			
Ration 1	\$ 59,337	\$ 100,627	\$ 212,257
Ration 2	\$ 61,355	\$ 105,217	\$ 222,543
Ration 3	\$ 62,946	\$ 108,399	\$ 228,907
NET CASH FLOW			
Ration 1	\$ 4,720	\$ 27,370	\$ 43,636
Ration 2	\$ 2,701	\$ 22,779	\$ 33,349
Ration 3	\$ 1,110	\$ 19,597	\$ 26,985
PRINCIPAL	\$ 3,219	\$ 7,835	\$ 15,917
Net for family living ration 1	\$ 1,500	\$ 19,535	\$ 27,718
Net for family living ration 2	\$ (518)	\$ 14,945	\$ 17,432
Net for family living ration 3	\$ (2,109)	\$ 11,763	\$ 11,068

* These budgets were created from a number of different 2006 sources and are meant solely as a guide. Actual figures should be inserted pertaining to your own farm.

Table A2.3

Comparison of Income and Expense on a per goat basis for herds of 100, 200 and 400 milking does*

Income/Expense Categories	Farm 1	Farm 2	Farm 3
Number of goats	100	200	400
Pounds of milk sold	1564	1564	1564
Milk price	\$ 35.08	\$ 35.08	\$ 35.08
CASH RECEIPTS			
Milk sales	\$ 549	\$ 549	\$ 549
Bonuses	\$ 63	\$ 63	\$ 63
Goat sales	\$ 16	\$ 16	\$ 16
Kids, bucks, and other Livestock	\$ 13	\$ 13	\$ 12
TOTAL CASH RECEIPTS	\$ 641	\$ 640	\$ 640
CASH EXPENSES			
Bedding	\$ 25	\$ 23	\$ 20
Chemicals	\$ 6	\$ 4	\$ 2
DHIA	\$ 27	\$ 22	\$ 19
Ration 1 (corn silage)	\$ 175	\$ 175	\$ 175
Ration 2 (haylage)	\$ 206	\$ 206	\$ 206
Ration 3 (hay)	\$ 222	\$ 222	\$ 222
Feeding kids and replacement	\$ 24	\$ 24	\$ 24
Freight and trucking	\$ 60	\$ 34	\$ 21
Gasoline, fuel and oil			
Ration 1	\$ 28	\$ 21	\$ 14
Ration 2-3	\$ 17	\$ 13	\$ 9
Insurance (other than health)	\$ 25	\$ 16	\$ 18
Interest	\$ 60	\$ 48	\$ 45
Labor hired, pension and profit sharing			\$ 65
Repairs and maintenance	\$ 33	\$ 23	\$ 21
Taxes	\$ 45	\$ 31	\$ 25
Utilities	\$ 30	\$ 30	\$ 30
Veterinary fees and medicine	\$ 13	\$ 13	\$ 13
Animal purchased	\$ 10	\$ 9	\$ 8
Supplies and miscellaneous	\$ 30	\$ 30	\$ 30
TOTAL CASH EXPENSES			
Ration 1	\$ 593	\$ 503	\$ 531
Ration 2	\$ 614	\$ 526	\$ 556
Ration 3	\$ 629	\$ 542	\$ 572
NET CASH FLOW			
Ration 1	\$ 47	\$ 137	\$ 109
Ration 2	\$ 27	\$ 114	\$ 83
Ration 3	\$ 11	\$ 98	\$ 67
PRINCIPAL	\$ 32	\$ 39	\$ 40
Net for family living ration 1	\$ 15	\$ 98	\$ 69
Net for family living ration 2	\$ (5)	\$ 75	\$ 44
Net for family living ration 3	\$ (21)	\$ 59	\$ 28

* These budgets were created from a number of different 2006 sources and are meant solely as a guide. Actual figures should be inserted pertaining to your own farm.

Table A2.4
Comparison of Income and Expense on a CWT basis for herds of 100, 200 and 400 milking does*

Income/Expense Categories	Farm 1	Farm 2	Farm 3
Number of goats	100	200	400
Pounds of milk sold			
Milk price	\$ 35.08	\$ 35.08	\$ 35.08
CASH RECEIPTS			
Milk sales	\$ 35.08	\$ 35.08	\$ 35.08
Bonuses	\$ 4.00	\$ 4.00	\$ 4.00
Goat sales	\$ 1.02	\$ 1.02	\$ 1.02
Kids, bucks, and other livestock	\$ 0.85	\$ 0.81	\$ 0.80
TOTAL CASH RECEIPTS	\$ 40.96	\$ 40.92	\$ 40.90
CASH EXPENSES			
Bedding	\$ 1.60	\$ 1.44	\$ 1.29
Chemicals	\$ 0.41	\$ 0.23	\$ 0.14
DHIA	\$ 1.75	\$ 1.41	\$ 1.24
Ration 1 (corn silage)	\$ 11.19	\$ 11.19	\$ 11.19
Ration 2 (haylage)	\$ 13.18	\$ 13.18	\$ 13.18
Ration 3 (hay)	\$ 14.20	\$ 14.20	\$ 14.20
Feeding kids and replacement	\$ 1.56	\$ 1.56	\$ 1.56
Freight and trucking	\$ 3.84	\$ 2.18	\$ 1.33
Gasoline, fuel and oil	\$ 0.00	\$ 0.00	\$ 0.00
Ration 1	\$ 1.80	\$ 1.35	\$ 0.90
Ration 2-3	\$ 1.10	\$ 0.82	\$ 0.55
Insurance (other than health)	\$ 1.62	\$ 1.05	\$ 1.12
Interest	\$ 3.86	\$ 3.07	\$ 2.86
Labor hired, pension and profit sharing	\$ 0.00	\$ 0.00	\$ 4.16
Repairs and maintenance	\$ 2.12	\$ 1.46	\$ 1.33
Taxes	\$ 2.89	\$ 1.99	\$ 1.63
Utilities	\$ 1.92	\$ 1.92	\$ 1.92
Veterinary fees and medicine	\$ 0.83	\$ 0.83	\$ 0.83
Animal purchased	\$ 0.64	\$ 0.56	\$ 0.52
Supplies and miscellaneous	\$ 1.92	\$ 1.92	\$ 1.92
TOTAL CASH EXPENSES			
Ration 1	\$ 37.94	\$ 32.17	\$ 33.93
Ration 2	\$ 39.23	\$ 33.64	\$ 35.57
Ration 3	\$ 40.25	\$ 34.65	\$ 36.59
NET CASH FLOW			
Ration 1	\$ 3.02	\$ 8.75	\$ 6.97
Ration 2	\$ 1.73	\$ 7.28	\$ 5.33
Ration 3	\$ 0.71	\$ 6.27	\$ 4.31
PRINCIPAL	\$ 2.06	\$ 2.50	\$ 2.54
Net for family living ration 1	\$ 0.96	\$ 6.69	\$ 4.92
Net for family living ration 2	(0.33)	\$ 5.22	\$ 3.27
Net for family living ration 3	(1.35)	\$ 4.21	\$ 2.26

* These budgets were created from a number of different 2006 sources and are meant solely as a guide. Actual figures should be inserted pertaining to your own farm.

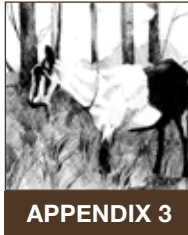

Risk Management and Crop Insurance

Provided by Pam Smith, Crop Insurance Coordinator, University of Vermont

As agricultural producers risk and the uncertainty of not knowing what will happen in the future plays a role in every business decision you make. Managing the risk of loss against the potential for profit is a constant balancing act with no guarantees. In addition, managing risk involves everything you do that can impact your bottom line and growth in net worth.

The addition a crop insurance policy as part of a risk management strategy is a tool that is increasing in popularity in the Northeast. In part, because some types of crop insurance policies are tailored for small, diversified agricultural producers and also because many lenders require crop insurance as a condition for financing.

Adjusted Gross Revenue-Lite (AGR-Lite) is a whole farm revenue protection plan of insurance that Vermont producers can use to protect against low revenue due to unavoidable natural disasters and market fluctuations that affect income.

- AGR-Lite uses your 5 year historical farm average revenue as reported on your IRS tax return, Form Schedule F or equivalent, and your annual farm report as a base to provide a level of guaranteed revenue for the insurance period; and

- Provides insurance coverage for most farm-raised crops, animals and animal products, including many commodities not individually covered under other insurance plans; and
- Establishes revenue as a common denominator for the insurance of all agricultural products.

As with all crop insurance policies, the Government will pay a portion of the premium for the AGR-Lite policy that equals 48 percent, 55 percent, and 59 percent of the total premiums for the coverage levels of 80 percent, 75 percent, and 65 percent, respectively. Insurance is provided against revenue loss due to any unavoidable natural occurrence during the current or previous insurance year or due to market fluctuations that cause a loss of revenue during the current insurance year. No payment is made due to negligence, mismanagement, or wrongdoing by you, your family, members of your household, tenants, employees, or contractors; crop abandonment; bypassing of acreage; or other uninsurable causes listed in your policy.

Crop insurance is sold and serviced by private agents. For more information contact an agent listed on the websites at the end of this article.

Key Dates for AGR-Lite insurance in Vermont include:

Sales Closing Date: **March 15**

Cancellation and Termination Date: **January 31**

Risk Management Agency

Partial funding to create this publication was provided by the USDA Risk Management Agency. The Risk Management Agency (RMA) provides sound risk management solutions for farmers. More

information is available at: WWW.RMA.USDA.GOV.

Small and beginning farmers can receive information and technical assistance on how to access and participate in RMA risk management programs. More information is available at:

WWW.RMA.USDA.GOV

WWW.AGRISK.BOG.UVM.EDU

WWW.VERMONTAGRICULTURE.COM/AGDEV/

[RISK%20MANAGEMENT/RISKMANAGEMENT.HTM](http://WWW.VERMONTAGRICULTURE.COM/AGDEV/RISK%20MANAGEMENT/RISKMANAGEMENT.HTM)

WWW.RMA.USDA.GOV.



APPENDIX 4

Barn Designs for 40, 60, and 288 Goats*

J. Marceau¹, M. Fortier², G. Gingras³, M. Dussault⁴, and L. Demers⁵

*The Agency of Environment and Sustainable Development and the Agency of Agriculture, Fisheries and Food of Quebec (MAPAQ), Chaudières-Appalaches, Estrie, and Central Quebec, have worked together to write this article. With permission, translation from the French by Jordan Le Roux and Carol Delaney with technical editing from Keith Kirchner. Original publication found at [WWW.AGRIRESEAU.QC.CA](http://www.AGRIRESEAU.QC.CA)

40-GOAT DAIRY BARN DESIGN**

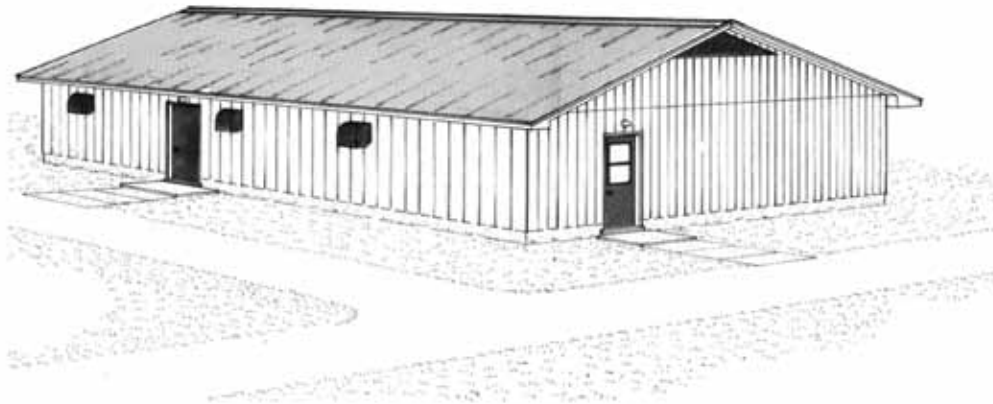

This design illustrates a barn for 40 milking goats and their replacements. For a herd of this size, which represents a fairly considerable operation, certain functional installations are essential in order to ensure a good plan.

This goat barn measures about 36 by 70 feet; it is free standing and only has one level. At one end it houses a milk room of about 10 by 12 feet and a 10-goat milking parlor that measures about 11 by 24 feet.

A central area about 33 feet long houses the milking string. This area is divided in two parts by two

sets of head gates; additional head gates are located at the requisite manger area at the end of the paddock. The other section of the barn comprises the kidding area and stalls for kids. There is also a grain room and a separate area for bucks.

This building of this barn requires construction of another building to store bedding and forage, with an access lane around the goat barn. However, this design imposes certain constraints on any future expansion to accommodate increasing herd size. In spite of that inconvenience, the design is well adapted and adequate for 40 milking goats.

**From MAPAQ publication 80265, "Chèvrerie de 40 Laitières." WWW.AGRIRESEAU.QC.CA. Translated by Carol Delaney.

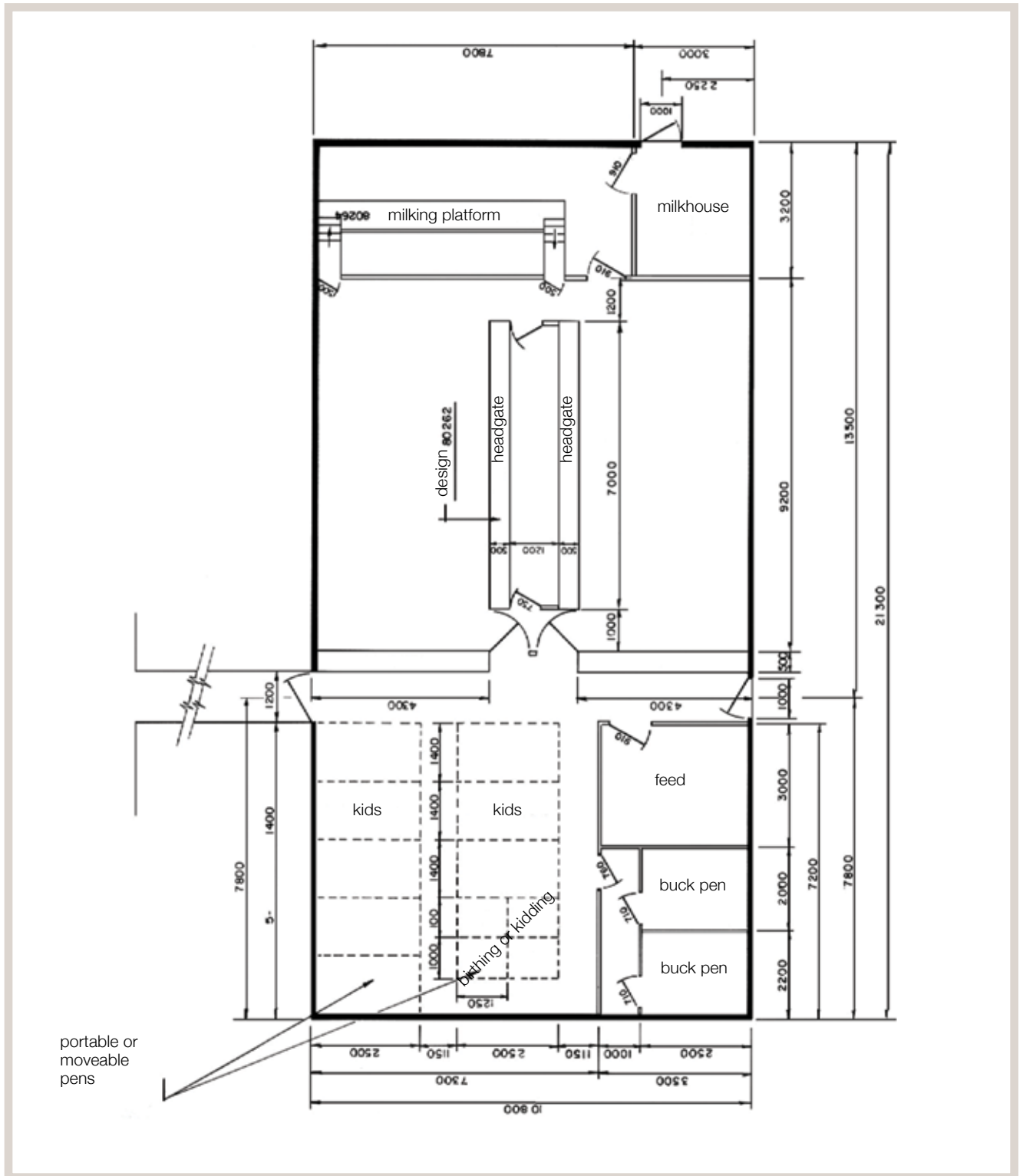
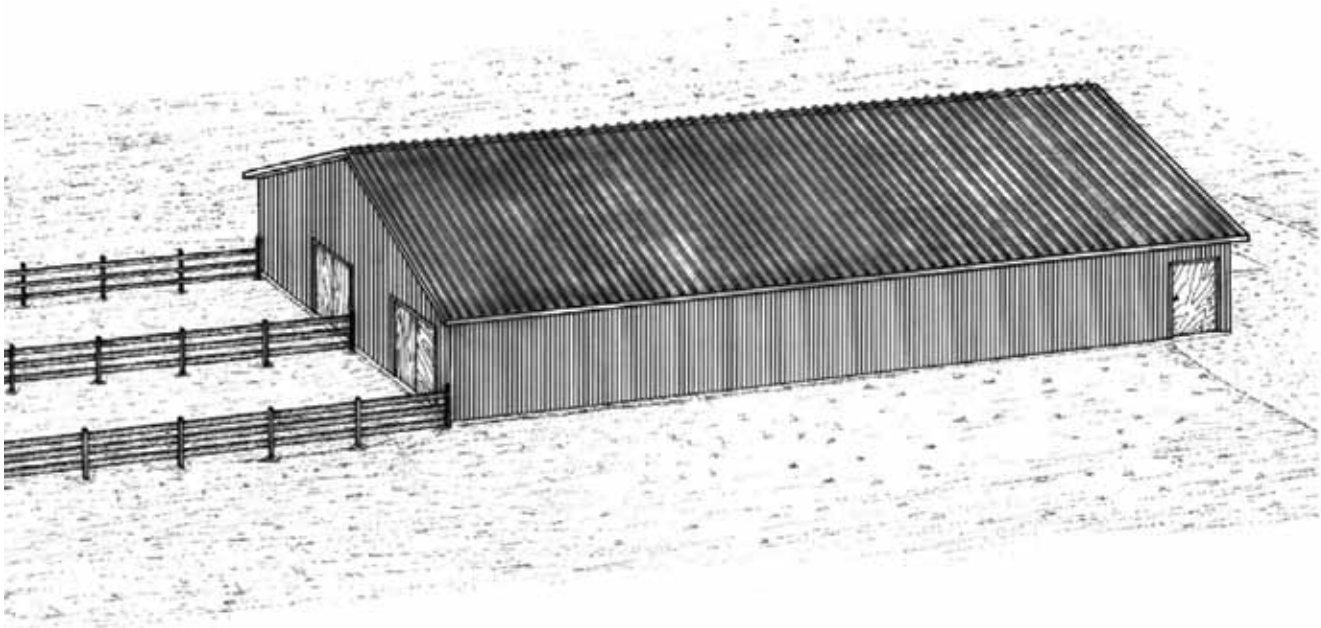

Figure A4.1 Floor plan for barn designed for a 40 goat dairy.

60-GOAT DAIRY BARN DESIGN*



This design illustrates a barn for 60 milking goats and their offspring. This size herd, being relatively substantial, necessitates a building well organized to permit an effectively ordered space.

This goat barn measures about 42 by 65 feet; it is free standing and has only one level. At one end it houses a milk room about 14 by 21 feet, a 10-goat milking parlor, a grain room, and a kidding area.

At the other end of the barn there are two pens for milkers, about 12 feet wide, each having a double door to the outside to permit the removal of bedding with a tractor. These pens are divided by a traffic alley bordered on each side by head gates.

A series of stalls for raising kids is lined up along the opposite wall. Bucks are housed separately in a small building to prevent any odor contamination.

For storing hay and straw, one must plan to build another structure.

It must be noted that the parlor is only single sided because it is placed strategically near the milkers' pens and the holding area. This allows an efficient way of milking the groups in rotation. This type of plan permits for further expansion. The building can be added on to at the ends of the pen and stall section without a problem.

*From MAPAQ publication 80266, "Chèvrerie de 60 Laitières" at www.AGRIRESEAU.QC.CA. Translated by Carol Delaney.

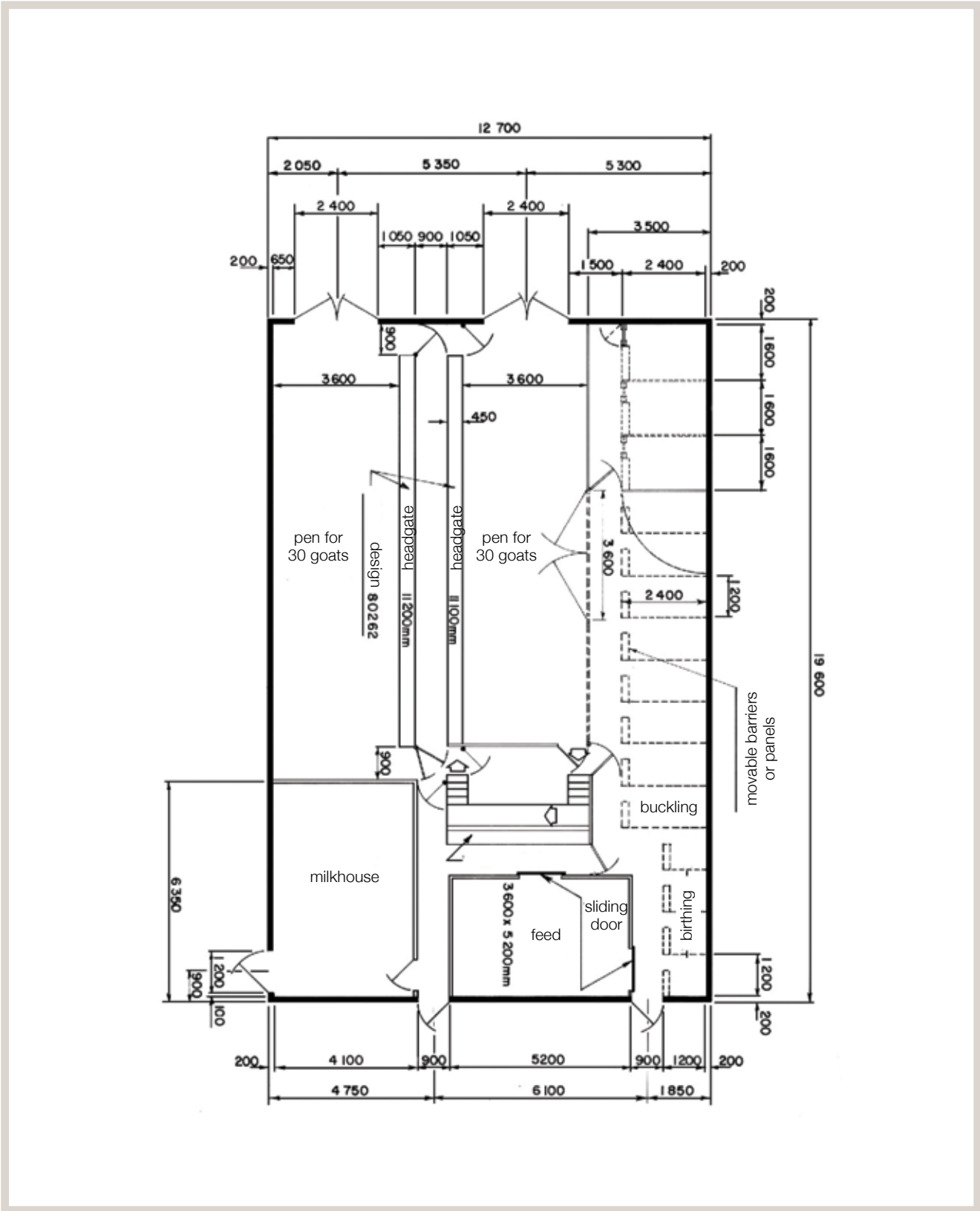
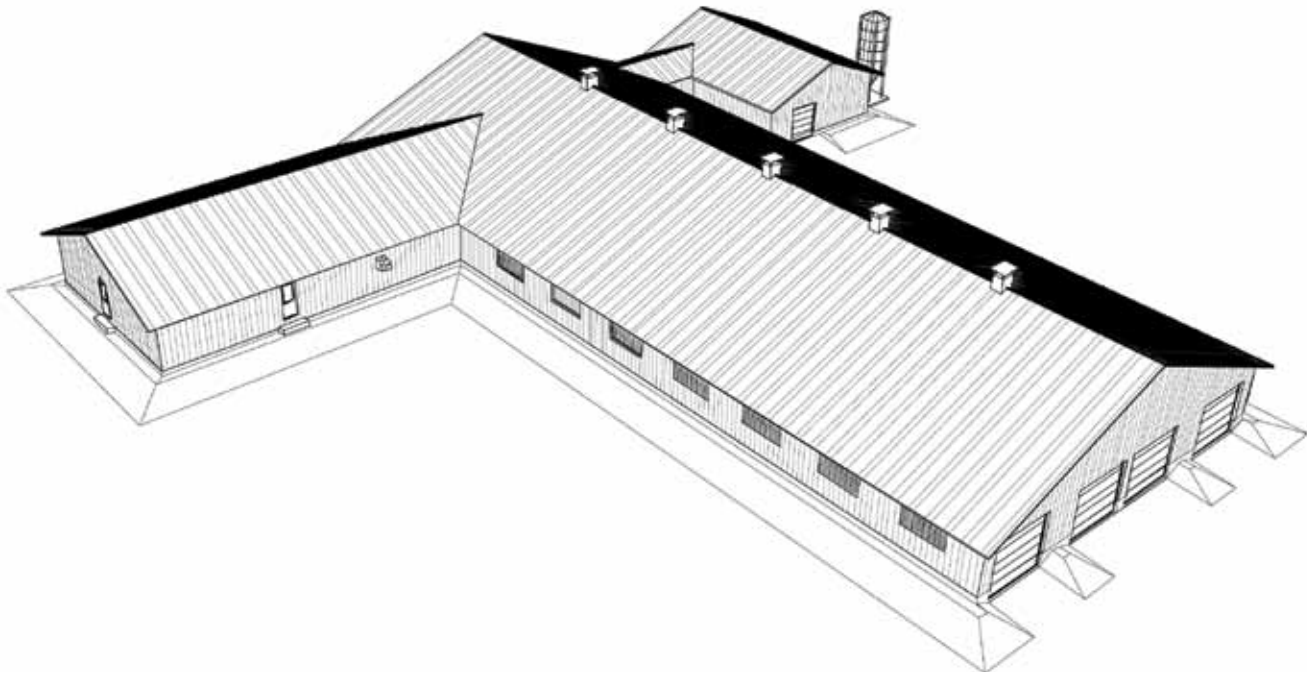

Figure A4.2 Floor plan for barn designed for 60-goat dairy (measurements in metric dimensions).

288-GOAT DAIRY BARN DESIGN WITH BEDDED PACK MANAGEMENT¹



In any plan to build a goat barn, it is important to assess the number and the size of goat groups, especially for night and morning milking. Often, groups are established according to lactation stages and feed needs. They may also be established by criteria such as age, lactation rank, or due dates. Generally, the larger the groups, the more herd management is eased regarding time to work, to feed, and to milk. However, it is recommended that animals be grouped as homogeneously as possible.

The number of animals to house depends on herd management factors that include replacement or cull rate, the raising of yearling does or buck kids for meat management, and the farm objective (e.g., to sell breeding stock or meat goats).

The pit and holding area in the milking parlor should be designed according to the number of people milking and number of goats to milk per group.

This article supplies the basics to build a barn for a 288-dairy goat operation. For this plan, there are four adult goat groups, a 36-unit milking parlor, and a 72-goat space for the holding area (see Figure A4.9). Raising kids and doelings, either for breeding or meat sales, is not considered in this article.

Compared to the documents 80265 and 80266 (originals at WWW.AGRIRESEAU.QC.CA/; see “40-Goat Dairy Barn” and “60-Goat Dairy Barn” in this appendix) that are buildings adapted for small herds (40 and 60), the main building is much larger than the barns designed for 40 and 60 goats in order to reduce distances for the goats during milking and other operations. A cathedral ceiling provides more air volume and eases ventilation.

Barn Layout

The barn shown here at a 69 foot width allows four strings of pens that will give you a building length of 158 feet. This compares to a narrower building that can only allow two strings of pens, which would then require the building to be 295 feet in length for the same number of goats. Although the floor space is somewhat reduced in the wider building, the construction cost is decreased significantly. This design also reduces the distance the animals must travel to the milking parlor by 35% as compared to the longer barn. The wing that includes the milk house, milking parlor, nursery, and other

¹Translated with permission from authors by Jordan Le Roux, Keith Kirchner, and Carol Delaney.

rooms is located at one end of the building. The opposing wing allows for buck housing, feed mixing, and storage. This layout permits a barn addition without any changes in the milking operation.

Herd

The 6,630 square feet of floor space in the main pens can house 438 animals. This breaks down to 288 milkers (approximately 16 square feet per animal), 25 dry goats, and 125 yearlings 2 to 12 months old (based on a 30% annual replacement rate). The 516-square-foot nursery area is large enough to house approximately 110 doelings from birth to 2 months. Up to eight bucks can be housed in the opposite wing.

Housing

The barn is insulated and ventilated. Inside temperatures should remain between 50° and 60.8°F in the winter, and humidity should not exceed 80%. Particular attention is paid to newborns, which should be housed at 77°F. Given the difficulty in maintaining this climate in the main barn, a separate kid room with its own ventilation and temperature control has been fitted specifically for the young stock.

Pens for goats and yearlings are 12 feet wide. Table 4A.1 indicates goat requirements for this type of farm.

In order to keep goats away from the feed alleys (to prevent feed contamination), 2-foot-wide alleyways for animal traffic are provided [editor's addition: along the walls of the building]. Feed alleys are raised approximately 16 inches above floor level. The 7-foot width of the feed alley allows enough space to install a feed rack with mechanical headlocks.

Different types of headlocks can be used. In the case of free-choice feeding, a simple gate can be used. If forage distribution is controlled, it is better to have headlocks that block goats either by group or individually (Figures A4.3, A4.4, and A4.5, page 147). These types of headlocks assure better control of feed intake. To avoid feed waste in the trough, a 6-inch wooden panel is fixed at the bottom of the headlock.

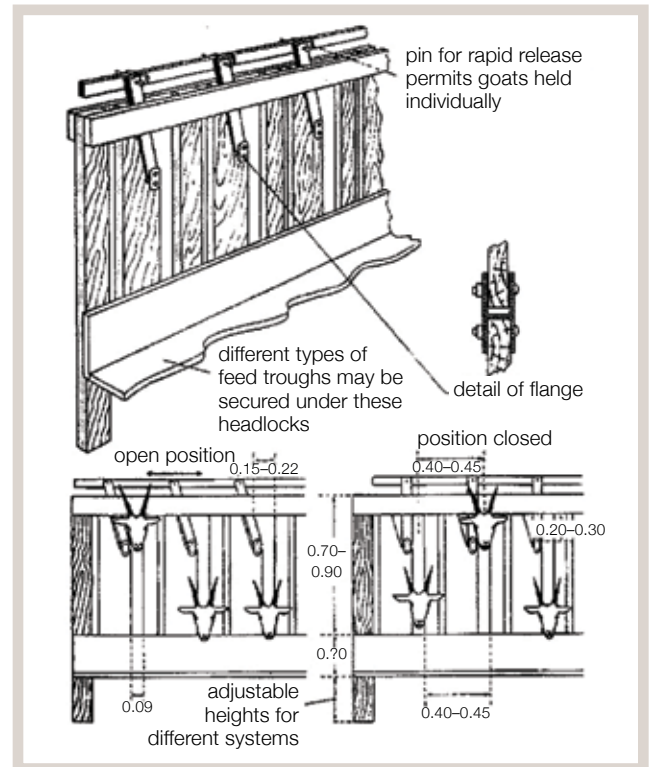

Figure A4.3 Headlock.

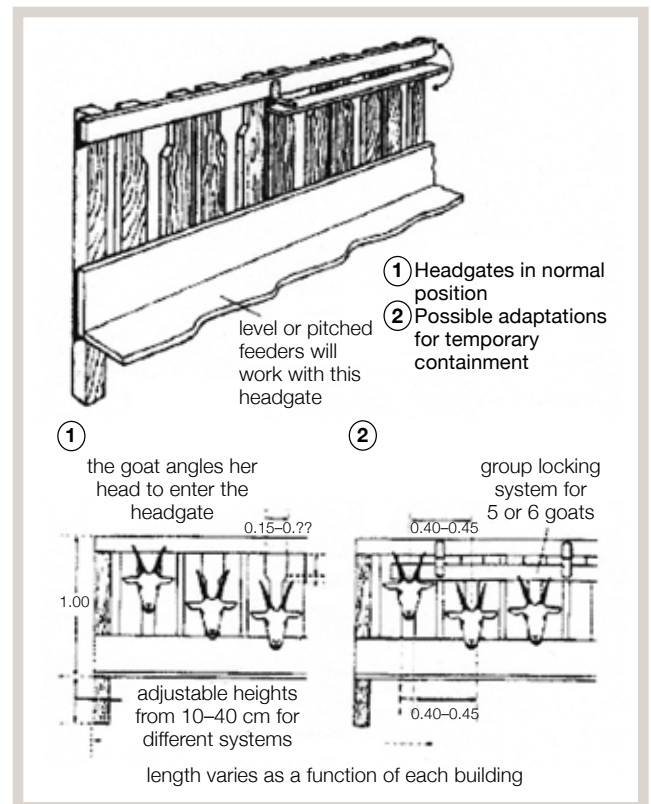

Figure A4.4 American headgates.

**Table A4.1
Some Technical Design Measurements for a Dairy Goat Barn**

		Weight of Goat	At Rest	In Activity
HEAT PRODUCTION	Sensible heat	79 lbs at 59°F	60 watts	86 watts
		130 lbs at 59°F	89 watts	126 watts
	Enthalpy change	79 lbs at 59°F	34 watts	42 watts
		130 lbs at 59°F	48 watts	62 watts
Moisture production		± 1.76 oz of water/hour/goat		

VENTILATION	Continuous	79 lbs at 59°F	0.04 ft ² /s	0.05 ft ² /s
		130 lbs at 59°F	0.05 ft ² /s	0.07 ft ² /s
	Humidity control	79 lbs at 59°F	0.08 ft ² /s	0.10 ft ² /s
		130 lbs at 59°F	0.14 ft ² /s	0.24 ft ² /s
	Heat control	79 lbs at 79°F	0.60 ft ² /s	0.90 ft ² /s
		130 lbs at 79°F	0.90 ft ² /s	1.27 ft ² /s

PREFERRED AMBIANCE	Minimum temperature	50 to 60°F (77°F for newborn)
	Maximum temperature	<80°F
	Moisture	65 to 80%
	Maximal air speed	1.64 ft/s (0.5m/s) = adults 0.65 ft/s (0.2m/s) = birth to 2-month-old kid

		Floor Space (sq ft/head)	Linear Feed Space (inch/head)
BUILDING	Adult	16.00	15.75
	Doeling from 7 to 12 months	11.00	14.00
	Doeling from 2 to 7 months	8.60	13.00
	Kid	3.25	6.00
	Buck	32.30	17.75
	Holding area	2.7 to 3.2	

WATER	Water quantity	0.80 to 3.2 gals/head/day
	Water bowl	1 per 25 head
	Water bowl height	35 inches from floor
	Location	Opposite side of headlocks

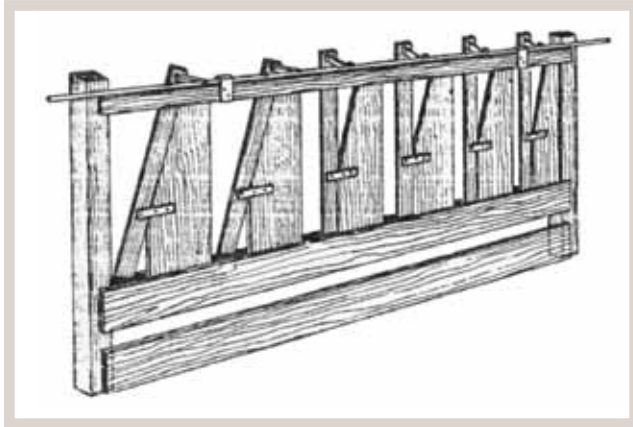

Figure A4.5 Self-locking headgates.

Gates 11.5 feet wide allow you to divide pens. Ideally, you could install a system that would allow you to progressively raise these gates as the bedding pack builds up.

Construction

Before building, contact the [state] department of agriculture to help you check the laws and regulations; i.e. milk house, milking parlor, construction, and manure management should be discussed with the Department of Agriculture.

Foundation and Floor

The barn has an 8-inch-deep by 16-inch-wide reinforced (rebar) concrete footing with 8-inch-wide reinforced concrete walls. The footing must be placed below the frost line and be adequately drained. The frost line varies according to weather conditions in each location and should not be less than 4 feet in northern climates but local codes should be consulted. The colder the climate — the deeper the footing.

Exterior walls should be insulated where possible in order to minimize thermal losses in the winter months. The thermal losses are limited by a type 4 polystyrene expanded and extruded insulation applied in all building perimeter. A floated paving stone may possibly be used in place of a deep foundation in some locations around the main barn area. In that case, the paving stone should rest on filling

materials (sand/gravel) 12–24 inches deep according to soil type. To use the paving stone, filling materials should be compacted in successive layers of 4–6 inches deep at 95% modified proctor.

When the soil has more clay, the thickness of the embankment is important. A drain allows to removal of water infiltration near the building and to prevent heaving risks by freezing. Details should be provided by an agricultural engineer and consult your local codes for guidance.

The milk house, milking parlor, and kid area should be built on a conventional foundation as some of these areas have different [elevated] floor levels [that require strong support].

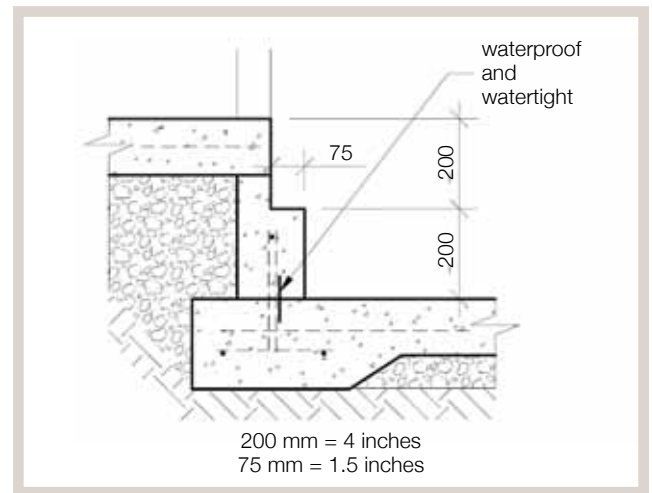

Figure A4.6 Foundation designed to be watertight (dimensions metric).

All alleyways, pens, and floors that animals will travel on should be constructed of 5-inch or more reinforced concrete, 3,500 psi, with a water/cement ratio of 0.45 and an air incorporation rate of 6%. Concrete should not be troweled too smooth, but instead should have a somewhat rough surface in order to provide solid footing, especially when wet.

The milk room and milking parlor will require a smoother surface and be sloped to drain for ease of maintenance and cleaning. Consult your Department of Agriculture for specific details.

To allow animals to feed when pens are cleaned and, therefore, empty of bedding, a foot/hof support of 3 inch wide in the pen side is located 8 inch

higher than pen floor. This support helps goats to eat more easily by standing on it. This does not get in a way of cleaning the pen.

Framing

Walls are constructed of standard 2 x 6 framing, 24 inches on center. They should be insulated with fiberglass or other moisture-resistant (vapor barrier) insulation (R-19, for example) as necessary to maintain a temperature above freezing during the winter months. This keeps the bedding from freezing so that it can be cleaned as necessary. Here, external facing is sheet metal or corrugated iron screwed on batten (0.75 inch x 2.5 inch) (see article 90101 www.AGRIRESEAU.QC.CA/).

Inside walls can be covered with galvanized roofing or sheet metal up to a height of 5 feet in order to prevent the goats from nibbling on the walls. Ceilings should be insulated, as well.

For interior finishing, battens, polyethylene film and fiber glass or other materials make up the ceiling. The global R-value of the roof is about 5.2 (see article 90101 at www.AGRIRESEAU.QC.CA/). If the interior finishing is constituted of material that transmits heat or cold, such as sheet metal or plastic facing, a material should be added in the internal side to prevent condensation.

The roof has a slope of 1 in 2.4 (5 in 12). It is constructed with scissor type rafters for the main building and conventional triangle rafters for other areas. They are made according to the weather condition with 1.5 inch x 2.5 inch battens according to contractor; the metallic covering has a caliber 26 or 28. Because the ridge of the roof is higher than other rooms, certain elements have to be strengthened to support large quantities of snow.

Note that rafter sizing, construction, and roof slope will be mandated by local codes, weather conditions, and snow load. Please consult an engineer or licensed builder for guidance.

Manure Management

Accumulated manure is managed in solid form and this method assumes the use of 4 inches of absorbent material, such as sawdust, as a base on

the pen floors, with the daily addition of litter or straw. The sawdust ensures comfort for the goats and makes removal of the bedding easier. The daily volume of manure produced, including the litter, represents approximately 0.22 cubic feet per day for an adult goat.

The pen floors, which are 16 inches lower than the alley floors, allow for a manure accumulation of two to three months in order to avoid cleaning during the winter months. The pen floors should not be any lower than this in relation to the feed alleys; health problems could develop if the bedding pack is low, and the goats must strain to get at the forage.

The manure is managed in liquid form in the nursery. Under a raised slatted floor of the kid pens, the areas are cleaned by scraping the manure into a gutter. Kids with an average weight of 22 pounds produce a daily volume of 0.13 gallon (0.02 cubic feet) of urine and manure. The wash water from the milk house and parlor washings (21–22.5 gallons per milking) is mixed with the nursery manure, and both are pumped or flow by gravity outside into a sealed tank with a 250-day storage capacity.

Artificial Lighting

Minimum artificial lighting in the goat barn should be 10 foot-candles (100 lux) at eye level. Twenty foot-candles (200 lux) is recommended for out of season light treatment at eye level, in the milking parlor at udder level, and in the milk house. Maximum lighting efficiency is obtained with fluorescent or halogen-type lights although other light types may also be used. White or light-colored walls and ceilings are recommended to improve light reflection. Other lighting types could be used; consult a specialist.

Ventilation and Heating System

Main Barn

During winter, temperature should be between 50° and 60.8°F (10–17°C) and humidity be maintained under 80%. During the summer, the temperature should not exceed 80°F (27°C). In order to

control lighting cycles for out of season breeding treatment, automatic ventilation is preferable. Fans placed at the bottom of the insulated chimneys in the center of the building draw the moist and hot air out of the building. Air inlets located in the outside walls provide fresh air. (These air inlets are shown in article 90312 at WWW.AGRIRESEAU.QC.CA/) Air inlet panels measuring 4 feet x 8 feet add ventilation during the hottest months. These open automatically but can be opened manually, as well.

Variable-speed fans provide a minimum turnover rate of 1.5 air changes per hour (0.05 cubic feet per second for this barn) and a maximum turnover rate of 12 air changes per hour (0.88 cubic feet per second) in order to maintain correct humidity levels. (Note: This is based on heat and moisture produced by a 132-pound, average-sized goat.)

Ventilation is properly maintained by an electronic regulator that controls two sectors of the barn independently. The air inlets and fans on each of half of the building are independently controlled. For each sector of the barn, it is a good idea to place four to six separate thermostats 10 feet from the walls and 6.5 feet above floor level. This arrangement provides a more precise reading of temperature than only one thermostat.

Natural ventilation can also be used if you do out-of-season breeding. However, you must have a separate building or area where you can control light and dark periods.

The relatively high metabolism of goats enables you to maintain the appropriate temperatures when the main barn is at full capacity. However, when cold weather sets in, a 72-kilowatt (15,000-Btu/hr) heater may be needed to maintain temperature. An 8-kilowatt (2,400-Btu/hr) heater is used in the nursery. They may be either propane or electric and are best mounted from the ceiling. A dedicated outdoor air inlet and vent must be provided for the combustion gases if you are using a propane unit. Installation of propane units should be done by a licensed professional and in accordance with local laws and regulations. Data here is provided for a Quebec climate; heating requirements may vary for your local weather conditions.

Kid Area and Milking Parlor

Ventilation and heating for the kid area and milking parlor are illustrated in Figures A4.7 and A4.8. Other alternatives can be used, however; consult an agricultural engineer or HVAC contractor.

A 59-foot-long, 2-foot x 2-foot square, insulated air duct divided into two longitudinal sections provides fresh air to the milking parlor and nursery. The air duct is insulated with 1½-inch-thick Styrofoam inside ⅜-inch plywood.

Two air inlets with adjustable covers located near the milk house, milking parlor, and nursery provide fresh air in warm weather. The covers are screened with ½-inch mesh hardware cloth to keep rodents and birds out and are covered with insulated panels during the winter months. In cold weather, a 2-inch cutout (with adjustable flap or baffle) in each section of the duct provides adequate inlet air.

Nursery

One or two thermostatically controlled fans located on the wall 15 inches below the ceiling pull stale air out of the building and provide from 1.5 to 20 air exchanges per hour. Fan capacities for this installation are 2.1 cubic feet per second minimum and 29 cubic feet per second maximum.

A 6-inch longitudinal and 3-inch wide air inlet is located in the ceiling with a flap (see article M-9750 at WWW.AGRIRESEAU.QC.CA/). See Figure A4.7.

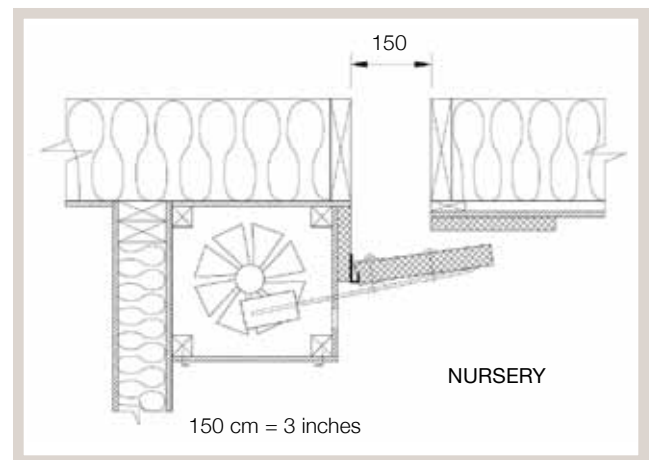

Figure A4.7 Air inlet in nursery ceiling.

Holes 1.5 inches in diameter spaced 24 inches apart in the air duct provide 1.5 to 2 times the required minimum recirculated air flow. An 8-inch-diameter variable-speed fan blowing air over a 3,000-watt heating element in this 12 x 12-inch duct pushes heated air into the nursery. A second thermostatically controlled fan in the nursery distributes the heated air and has its own 2,000-watt heating element. Together, they provide 1,500 BTUs per hour of heat into the nursery.

Milking Parlor

One or two thermostatically controlled fans located on the wall 15 inches below the ceiling provide air circulation, as in the nursery (see Figure A4.8). A 6-inch-wide longitudinal air inlet located in the ceiling with an air flap blows fresh air uniformly into the holding area and the milking parlor (see article 90312 at www.AGRIRESEAU.QC.CA/). A small supplemental heater may be necessary to provide heat to the parlor.

Nursery and Milking Area

This wing is attached to the main barn and includes the milk house, generator room, nursery, and holding area (see Figure A4.9, page 151).

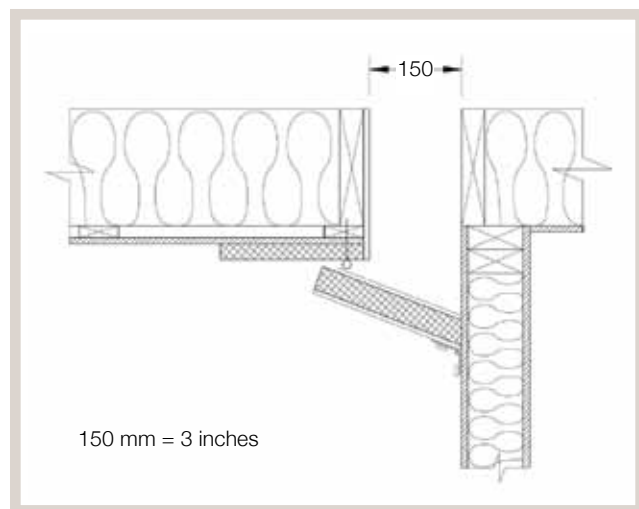

Figure A4.8 Air inlet on ceiling of milking parlor.

Milk House

Milk house design for this Quebec dairy facility is provided in article 20508 named “Laiterie de Ferme” from MAPAQ (Agency of Agriculture, Fisheries and Food of Quebec) at www.AGRIRESEAU.QC.CA/). Milk house design is rigidly regulated by each state or provincial authority. Consult your local Department of Agriculture prior to design and construction for guidance.

Milking Parlor

The double-sided milking parlor deck is 3 feet above the pit floor. Decks are 18 feet long, and the parlor can handle 36 goats, with the same number waiting in the holding area. The slope of the decks can vary from 5% to 10% from entrance to exit. It helps to align goats, heads up, coming into the parlor. The 6-foot-wide pit allows enough space to hide and protect pipelines. Milking parlor design and construction are regulated by the local Department of Agriculture and must be approved in advance of construction.

Nursery

A 520-square-foot room can hold approximately 110 kids from birth to 2 months old. The floor is perforated (or on expanded metal) and raised 12 inches above the floor, allowing adequate room for a scraper below that will collect the manure into a gutter cleaner for removal.

Feed and Bucks’ Area

A 38 x 32-foot wing is connected to the main barn by a corridor that serves to distribute hay and grain. This room can be used to thaw round bales in winter. This part of the barn can house up to eight bucks and should be ventilated and heated as well. For more information, consult “Le guide Chèvre” (1998 Publication AR001, Conseil des Production Animales du Québec, ISBN 2-89459-034-2) and an engineer from MAPAQ or a consultant in agricultural engineering.

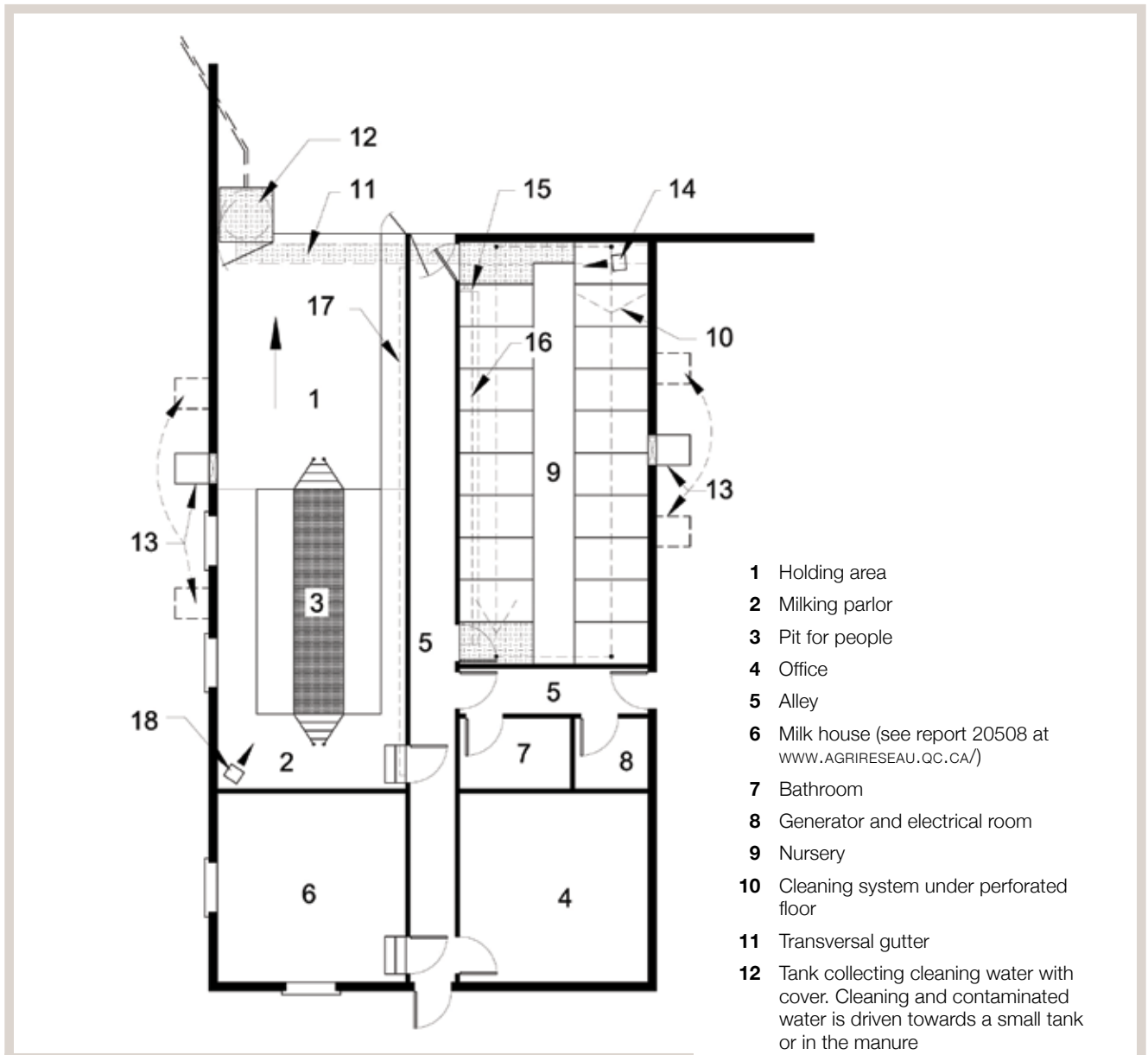
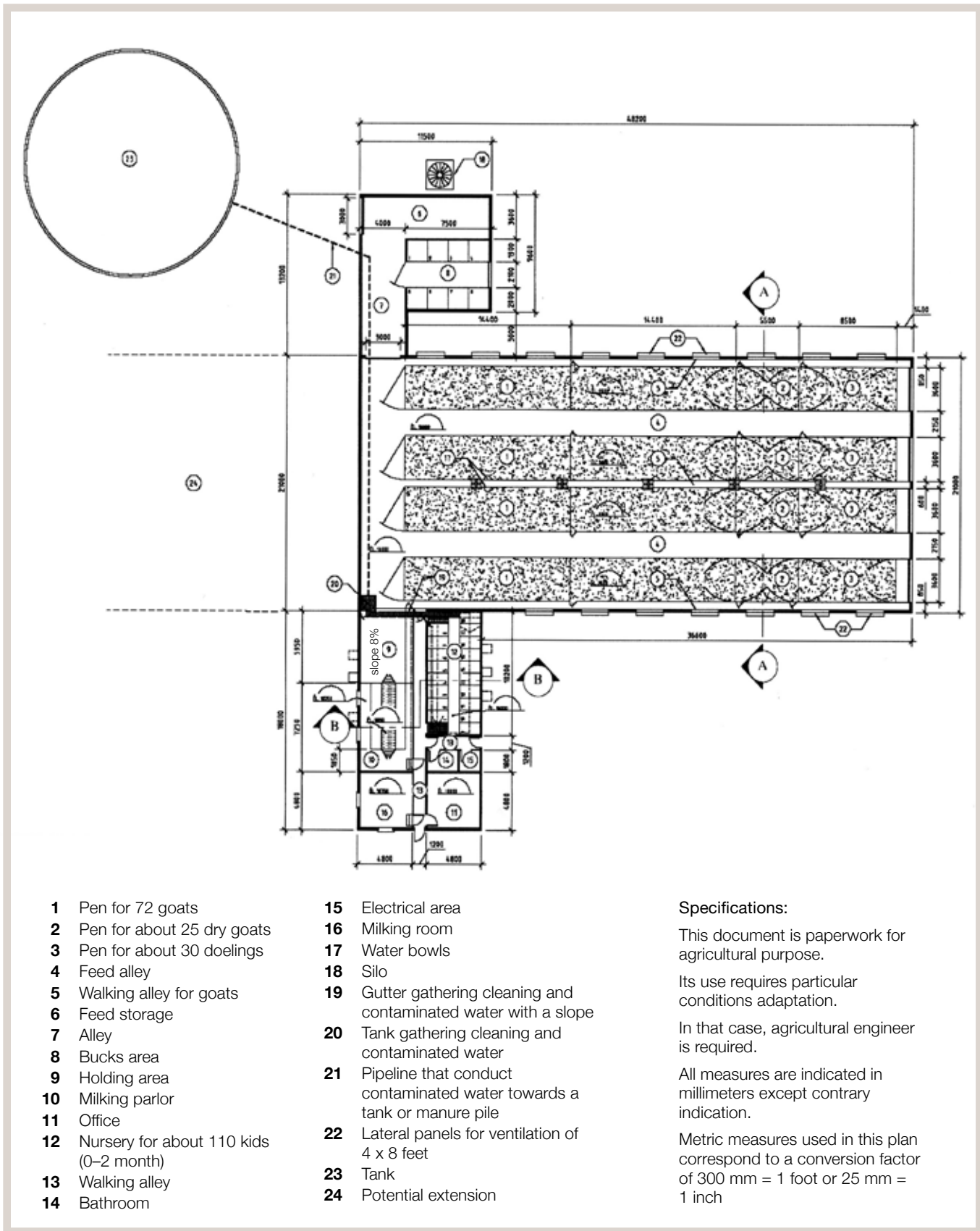

Figure A4.9 Barn floor plan for nursery, milk house, milking parlor and office area

ENDNOTES

1. Jocelyn Marceau, Engineer, Quebec Regional Department of MAPAQ,
2. Michel Fortier, Engineer, Chaudière and Appalaches Regional Department of MAPAQ,
3. Gaétan Gingras, Engineer and Agronomist, Sustainable Development and Environment Department of MAPAQ,
4. Marcel Dussault, Engineer and Agronomist, Estrie Regional Department of MAPAQ,
5. Laurent Demers, Engineer and Agronomist, Central Quebec Regional Department of MAPAQ.

- 1 Holding area
- 2 Milking parlor
- 3 Pit for people
- 4 Office
- 5 Alley
- 6 Milk house (see report 20508 at [WWW.AGRIRESEAU.QC.CA/](http://www.AGRIRESEAU.QC.CA/))
- 7 Bathroom
- 8 Generator and electrical room
- 9 Nursery
- 10 Cleaning system under perforated floor
- 11 Transversal gutter
- 12 Tank collecting cleaning water with cover. Cleaning and contaminated water is driven towards a small tank or in the manure
- 13 Cleaning system under perforated floor
- 14 2000 watts areo-thermal fan
- 15 Speed controlled fan with an 8-inch diameter
- 16 Air duct with 1.50 inches diameter holes every 24 inches and an air inlet trap
- 17 Air inlet going to milking parlor and holding area
- 18 3000 watts areo-thermal fan in the milking parlor



- | | |
|---|--|
| <ul style="list-style-type: none"> 1 Pen for 72 goats 2 Pen for about 25 dry goats 3 Pen for about 30 doelings 4 Feed alley 5 Walking alley for goats 6 Feed storage 7 Alley 8 Bucks area 9 Holding area 10 Milking parlor 11 Office 12 Nursery for about 110 kids (0-2 month) 13 Walking alley 14 Bathroom | <ul style="list-style-type: none"> 15 Electrical area 16 Milking room 17 Water bowls 18 Silo 19 Gutter gathering cleaning and contaminated water with a slope 20 Tank gathering cleaning and contaminated water 21 Pipeline that conduct contaminated water towards a tank or manure pile 22 Lateral panels for ventilation of 4 x 8 feet 23 Tank 24 Potential extension |
|---|--|

Specifications:
 This document is paperwork for agricultural purpose.
 Its use requires particular conditions adaptation.
 In that case, agricultural engineer is required.
 All measures are indicated in millimeters except contrary indication.
 Metric measures used in this plan correspond to a conversion factor of 300 mm = 1 foot or 25 mm = 1 inch

Figure A4.10

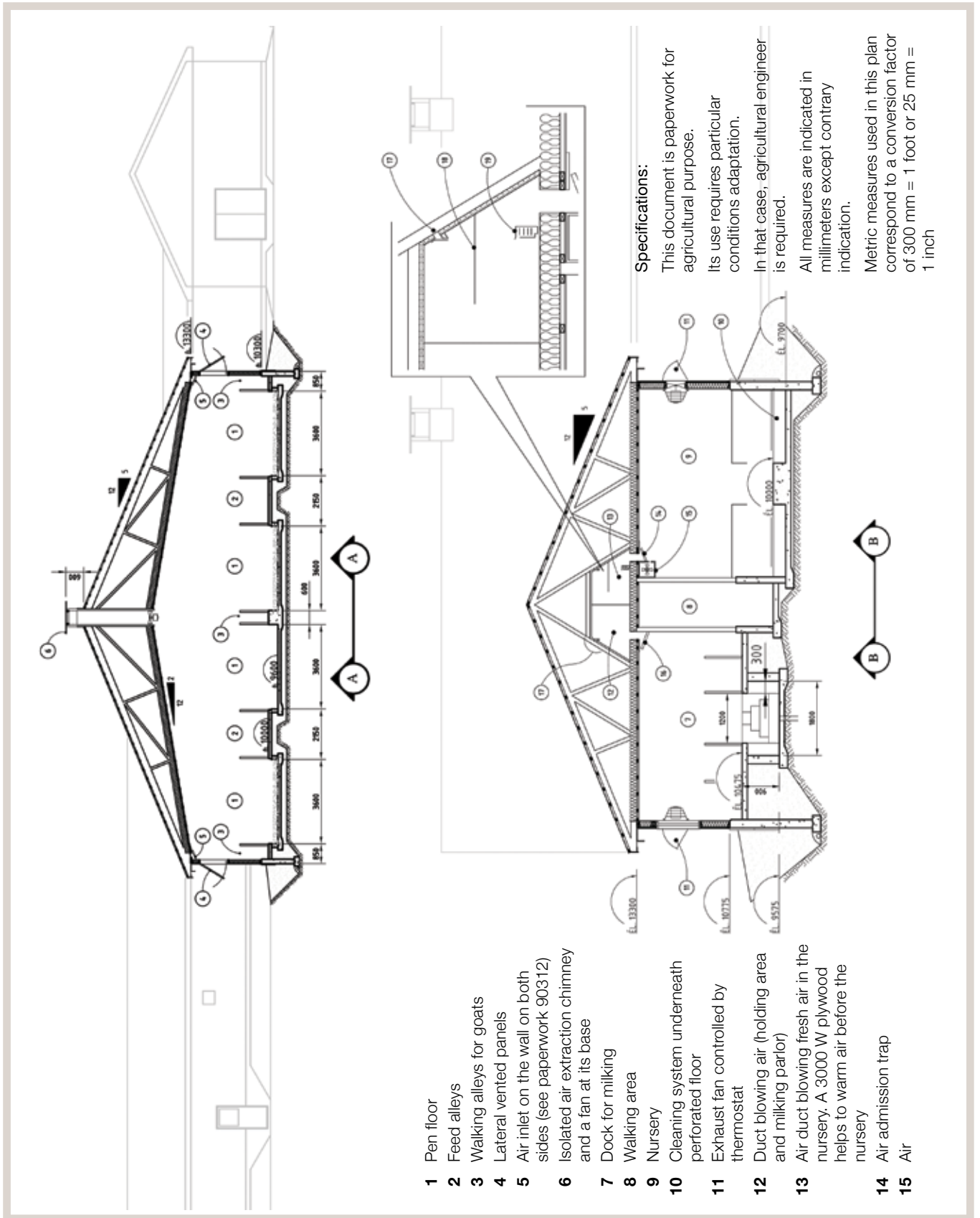
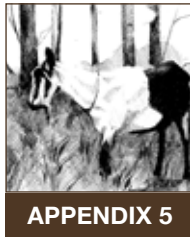

Figure A4.11



Dairy Goat Milking Facilities¹

John C. Porter

Regardless of the size of a dairy goat operation, provision needs to be made for milking. Goats are generally housed in group pens and should be removed from that environment to be milked. A small herd may only need an isolated corner or area set aside for milking, whereas a commercial dairy would need a separate room often referred to as a milking parlor. The key to any system is that it be separated from bedded areas and easily cleaned and kept sanitary, and it must meet public health requirements if milk is commercially produced.

The most basic system is to use a milking stand for the goats while they are being milked. This separates the goat from the housing area and confines it, as well as providing an opportunity for individual grain feeding. A milking stand will suit the needs of smaller dairy goat farms and can be used for hand milking as well as with milking machines. A wooden milking stand can be adequate for home use, but on commercial dairies, all contact surfaces must be made from impervious materials such as concrete or steel.

A basic milking parlor can be set up with a series of milking stands placed side by side with space in between for the operator. They should be arranged in such a way that goats enter at one end of the room and exit at the other to provide for good ani-

mal flow. A pipeline can be mounted overhead with the goat being milked from the side or the rear.

Types of Milking Parlors

Milking parlors are often constructed with a pit that puts the operator below the level of the goats to provide easy access to the udder; or the parlor can be an elevated platform which puts the animal at about waist level, and then the goats enter and exit by way of a ramp. The types of parlors listed below could be built either way.

Herringbone Parlor

The herringbone parlor is commonly used with dairy cattle. There is a pit in the middle so the animals stand elevated to the operator at a 30- to 40-degree angle on both sides of the pit for easy access to the udder. With goats there could be a problem in properly positioning them and the short length of the animal might make the angle less of an advantage. The pit should be 6–7 feet wide, and the working height of the animal platform needs to be custom-designed to the comfort of the operator to avoid bending, but often varies between 34–40 inches high. The animals enter and exit as a group, which makes efficient animal handling, but a slow-

milker will detain the whole string. For efficient traffic flow, there should be a holding area outside the parlor to hold animals close to the entrance and a well-defined exit alley to direct the animals back to the barn.

Straight-Through Parlor

A straight-through parlor is similar to the herringbone, but the animals do not stand at an angle to the operator. They are lined up head to tail and enter and exit as a group. This makes positioning the animal easier and there is a short distance from udder to udder between goats, which provides for efficient handling of the milker unit. Often times headlocks are mounted on the side of the parlor next to the operator, and each goat stands with its head locked in place and its body parallel to the operator. With the goats' heads facing the operator, grain can be fed on the side next to the parlor pit, making an easy access for re-filling the grain boxes.

Parallel Parlor

In the parallel parlor, the animals are elevated above the pit and stand parallel to one another, facing away from the operator on one or both sides of the pit. Only the rear udder is accessible, which is convenient but could be a problem for goats with non-symmetrical teat placement. The pit dimensions are similar to those outlined previously for the herringbone parlor, but the pit is sometimes deeper for easier access to the udder. With the animals standing parallel, more animals can fit in a space than a herringbone; however, additional space is needed in front of the animals so they can be exited out the front or off to the side by lifting the restraining bar. Provision needs to be made for collecting the urine and manure to deflect it from the milking area.

Side Opening Parlor

The side opening parlor is another option for dairy goat operations. There is a pit similar to the ones described previously, but the goats stand in individual stall units which run parallel to the pit, with the animals in a line head to tail, often separated by a grain feeder. The animals can enter and

exit at their own pace and not affect the rest of the animals. While individual stalls help in handling each goat as a separate unit, they do create more opening and closing of gates and there is a greater distance to walk from one milking unit to the next.

Rotary Parlor

The rotary parlor can be more expensive and may add some more animal handling considerations to properly channel the animals onto the rotating parlor. These are set up for either the operator to be inside the pit with the animals rotating around them on a circular platform facing out, or the animals face the center of the circle and the platform rotates by the operators who work along the outside circumference.

These are mechanically propelled at a slow speed to keep the animals progressing around the circle to the exit as they complete milking. The platform can be suspended on water or on a metal track so it is easily rotated with a small motor. This type of parlor is more suited for large, commercial operations.

Parlor Mechanization

There is a wide variety of equipment available which can be installed to mechanize a milking parlor operated on a large commercial scale. Some of these include:

Automatic detachers: These units sense the milk flow and shut off the vacuum and remove the unit when milking is complete. There can be a flexible arm or a retractable cord, depending upon which type better fits the parlor design. These are used in dairy cattle milking parlors, but the expense is usually not justified with dairy goats.

Crowd gates: A crowd gate can be electronically controlled to advance forward and keep the animals confined to a smaller area and encourage them to enter the parlor.

Power gates and doors: Power operated entrance and exit doors can be opened and closed with pneumatic cylinders. This saves pulling ropes and hav-

ing to walk from one end of the parlor to the other to open and close doors.

Feed gates and feed bowlcovers: These can be used in a parlor to prevent animals from stopping and eating as they walk past feed in mangers. Covers or gates can open in sequence as animals enter or close in sequence as they exit the parlor.

Milk meters and recorders: Electronic and mechanical flow-through meters are available to record milk production on each animal. The data can be manually or electronically recorded and compiled to assist in herd management decisions.

Milking Parlor Construction

The milking parlor should be a separate room but readily accessible to both the milk room and animal housing area. Consideration needs to be given to adequate drainage and proper joining of roof lines to maintain the slope needed to minimize snow loads. Milking parlors are humid areas due to the large amount of water used for cleaning, so construction materials and methods need to take this into account.

Below are a few key points:

- There should be an 18-inch high concrete base wall to prevent rotting of the sills.
- Wood frame walls are recommended above the concrete, insulated to R-19.
- Inside wall and ceiling surfaces should be water-resistant, cleanable, and smooth. Well-sealed fiberglass or plastic board is preferable to paint.
- Floors need to be relatively smooth for cleaning but have enough texture to be slip-free.

- Lighting should illuminate animals properly for milking.
- Floors should be sloped in one direction to a cross channel which slopes to a drain located in the corner.
- Ventilation and fresh air inlets need to be provided.
- Provisions need to be made for adequate electric and water supplies.
- There should be good animal flow in and out of the parlor.
- Parlor platforms are often 34–40 inches from the floor, depending upon the height of the operator.

Milking Equipment

When several goats are being milked on the farm, it generally necessitates the use of milking machines. There are complete, self-contained milk units built for goats that include the compressor and milker unit on a portable stand. Care should be taken when purchasing some of these units to make sure they have adequate capacity for proper milking. New or used dairy cattle equipment can also be adapted to goats. The components are basically the same whether cows or goats are being milked, with the exception of the milker claw, which only needs two teat cups for goats; however, there are some equipment specifications that need to be modified for goats (see Table A5.1).

ENDNOTE

1. Porter, J. C. 1998. *Dairy Goat Milking Facilities*, pp. 25–29 in Proc. 13th Ann. Goat Field Day, Langston University, Langston, OK. *Permission to reprint from author.*

Table A5.1
Specifications for dairy goat milking equipment.*

Item	Specifications		
Pulsation speed:	60–85 pulsations per minute (ppm)**		
Milk to rest ratio:	50:50–70:30***		
Inches of operating vacuum:	High line 13–14 inches Low line 11–13 inches Mid line 12–13.5 inches		
Minimum air flow requirements (extrapolated from cow data):	Bucket system —	Base Additional, per milking unit	10 cfm 2 cfm
	Pipeline —	Base Additional, per milking unit	25 cfm 2 cfm
Milk line:	A 1½-inch diameter stainless steel line can be used for up to 3–4 units per slope and a 2-inch line can handle 6–8 units per slope. Larger milking systems need to be designed according to manufacturers' recommendations.		
Clawless units:	When using direct feed into the line without a milking claw, 3 feet of milk tube is needed between the inflation and the fork or joining device.		

*These specifications are just rough guidelines. A milking system should be carefully designed using the manufacturers' recommendations. A lot of the guidelines being used today are extrapolations from cow data, and more research needs to be done with dairy goats. A milking system needs to be laid out for efficient operation that is gentle on the animal, designed for proper cleaning, and meets public health regulations. The goal is to produce quality milk to ensure a safe and high quality milk supply for the marketplace.

*Speeding up a pulsator designed to operate in the 45–60 ppm range used by cows to 85–120 ppm used by goats may not give the desired effect as the opening and closing times may take up too much of the cycle.

**50:50 is for simultaneous pulsation only.

