

MILLI-Q[®] ADVANTAGE A10[®] SYSTEM

USER MANUAL



Safety Information

Safety Statement

Your Milli-Q System should be operated according to the instructions in this manual. In particular, the hydraulic and electrical specifications should be followed and met. It is important to use this equipment as specified in this manual; using this equipment in a different manner may impair the safety precautions of the Milli-Q System.



Do not remove the covers of the Milli-Q System at any time. Electrical and mechanical components inside the Milli-Q System could pose a hazard. A qualified Millipore® Service Representative should perform any work that needs to be done while the Milli-Q System is opened.

Safety Symbols

SYMBOL

WHAT IT MEANS



This HAZARD symbol is used to refer to instructions in this manual that need to be done safely and carefully.



This ATTENTION symbol is used to refer to instructions in this manual that need to be done carefully.



This UV RADIATION sticker is used to refer to a position on the Milli-Q System Cabinet or inside of it where exposure to UV light is possible.



This DANGER sticker is used to refer to a position on the Milli-Q System Cabinet or inside of it that could be hazardous.



This ELECTRICAL GROUND sticker is used to refer to a position on the Milli-Q System Cabinet or inside where an electrical ground connection is made.



This ELECTRICAL DANGER sticker is used to refer to a position on the Milli-Q System Cabinet or inside where an electrical danger could exist.

Notice

The information in this document is subject to change without notice and should not be construed as a commitment by Millipore Corporation. Millipore Corporation assumes no responsibility for any errors that might appear in this document. This manual is believed to be complete and accurate at the time of publication. In no event shall Millipore Corporation be liable for incidental or consequential damages in connection with or arising from the use of this manual.

We manufacture and sell water purification systems designed to produce pure or ultrapure water with specific characteristics ($\mu\text{S}/\text{cm}$, T, TOC, CFU/ml, Eu/ml) when it leaves the water purification system provided that the Milli-Q System is fed with water quality within specifications, and properly maintained as required by the supplier.

We do not warrant these systems for any specific applications. It is up to the end user to determine if the quality of the water produced by our systems matches his expectations, fits with norms/legal requirements and to bear responsibility resulting from the usage of the water.

Millipore's Standard Warranty

Millipore Corporation ("Millipore") warrants its products will meet their applicable published specifications when used in accordance with their applicable instructions for a period of one year from shipment of the products. **MILLIPORE MAKES NO OTHER WARRANTY, EXPRESSED OR IMPLIED. THERE IS NO WARRANTY OF MERCHANTABILITY OR FITNESS FOR A PARTICULAR PURPOSE.** The warranty provided herein and the data, specifications and descriptions of Millipore products appearing in Millipore's published catalogues and product literature may not be altered except by express written agreement signed by an officer of Millipore. Representations, oral or written, which are inconsistent with this warranty or such publications are not authorised and if given, should not be relied upon.

In the event of a breach of the foregoing warranty, Millipore's sole obligation shall be to repair or replace, at its option, the applicable product or part thereof, provided the customer notifies Millipore promptly of any such breach. If after exercising reasonable efforts, Millipore is unable to repair or replace the product or part, then Millipore shall refund to the customer all monies paid for such applicable product or part. **MILLIPORE SHALL NOT BE LIABLE FOR CONSEQUENTIAL, INCIDENTAL, SPECIAL OR ANY OTHER INDIRECT DAMAGES RESULTING FROM ECONOMIC LOSS OR PROPERTY DAMAGE SUSTAINED BY ANY CUSTOMER FROM THE USE OF ITS PRODUCTS.**

COPYRIGHT

© 2006 MILLIPORE CORPORATION. PRINTED IN FRANCE. ALL RIGHTS RESERVED. THIS BOOK OR PARTS THEREOF MAY NOT BE REPRODUCED IN ANY FORM WITHOUT THE WRITTEN PERMISSION OF THE PUBLISHERS.

REV. 0, 11/06

TRADEMARKS

Millipore, A10, Elix, Q-Gard, Milli-Q, Millipak and Milli-RO are registered trademarks of Millipore Corporation.

BioPak, Quantum, Milli-RX, RiOs and Q-POD are trademarks of Millipore Corporation.

All other trademarks are trademarks of their respective manufacturers.

CHAPTER 1	INTRODUCTION	1
SECTION 1-1	PURPOSE OF THIS USER MANUAL	1
SECTION 1-2	ABOUT MILLIPORE	1
CHAPTER 2	PRODUCT INFORMATION	2
SECTION 2-1	OVERVIEW OF THE MILLI-Q WATER SYSTEM	2
SECTION 2-2	MILLI-Q® WATER SPECIFICATIONS	4
SECTION 2-3	FLOW SCHEMATIC	4
SECTION 2-4	TECHNICAL SPECIFICATIONS	7
CHAPTER 3	INSTALLATION	9
SECTION 3-1	INSTALLATION REQUIREMENTS	9
SECTION 3-2	ASSEMBLING THE Q-POD DISPENSER	11
SECTION 3-3	CONNECTING THE Q-POD DISPENSER TO THE MILLI-Q SYSTEM CABINET	12
SECTION 3-4	FEEDWATER CONNECTION TO THE MILLI-Q SYSTEM CABINET	16
SECTION 3-5	QUICK REFERENCE GUIDE	17
SECTION 3-6	MILLI-Q SYSTEM IS POWERED ON	18
SECTION 3-7	Q-GARD PACK INSTALLATION	20
SECTION 3-8	QUANTUM CARTRIDGE INSTALLATION	22
SECTION 3-9	RINSING THE MILLI-Q	24
SECTION 3-10	A10 TOC MONITOR CLEANING	25
SECTION 3-11	INSTALLATION OF THE POD PAK	25
SECTION 3-12	HOW TO REGISTER A POD PAK BEING INSTALLED	27
SECTION 3-13	HOW TO ENTER THE MANAGER MENU	28
SECTION 3-14	SELECTING THE LANGUAGE	29
SECTION 3-15	SETTING THE DATE AND TIME	30
SECTION 3-16	CALIBRATING THE MILLI-Q WATER FLOWRATE	31
SECTION 3-17	CHANGING THE SET POINTS	32
SECTION 3-18	OTHER SETTINGS	34
SECTION 3-19	REGISTERING UV AND A10 LAMPS LIFETIME	41
CHAPTER 4	USING THE MILLI-Q SYSTEM	43
SECTION 4-1	MILLI-Q SYSTEM CABINET KEYPAD AND LCD	43
SECTION 4-2	SOFTWARE MAP	44
SECTION 4-3	STANDBY MODE AND READY MODE	45
SECTION 4-4	HOW TO DISPENSE WATER	46
SECTION 4-5	VIEWING AND PRINTING WATER QUALITY	49
SECTION 4-6	UNDERSTANDING THE Q-POD DISPENSER DISPLAY AND KEYPAD	51
SECTION 4-7	PRINTING THE SYSTEM HISTORY	53

TABLE OF CONTENTS

SECTION 4-8	VIEW OPERATION	54
SECTION 4-9	VIEWING CONSUMABLES STATUS	55
SECTION 4-10	CALL MILLIPORE	56
SECTION 4-11	VIEWING SERVICE TRACKING	56
SECTION 4-12	VIEWING INFORMATION	57
CHAPTER 5	MAINTENANCE	58
SECTION 5-1	MAINTENANCE SCHEDULE	58
SECTION 5-2	HOW TO REPLACE THE Q-GARD PACK	59
SECTION 5-3	HOW TO REPLACE THE QUANTUM CARTRIDGE	63
SECTION 5-4	HOW TO REPLACE A POD PAK	68
SECTION 5-5	HOW TO REPLACE THE UV 185 NM LAMP	70
SECTION 5-6	HOW TO REPLACE THE A10 LAMP	70
SECTION 5-7	CLEANING THE A10 TOC MONITOR	71
SECTION 5-8	HOW TO CLEAN THE INLET STRAINER	72
CHAPTER 6	ALERT AND ALARM MESSAGES	74
SECTION 6-1	WHAT ARE ALERT AND ALARM MESSAGES?	74
SECTION 6-2	HOW TO SEE AND CANCEL ALERT MESSAGES	75
SECTION 6-3	HOW TO SEE AND CANCEL ALARM MESSAGES	79
SECTION 6-4	SUMMARY OF ALERT MESSAGES AND WHAT TO DO	82
SECTION 6-5	SUMMARY OF ALARM MESSAGES AND WHAT TO DO	84
CHAPTER 7	ORDERING INFORMATION	89
SECTION 7-1	CATALOGUE NUMBERS FOR CONSUMABLES	89
SECTION 7-2	CATALOGUE NUMBERS FOR ACCESSORIES	90
SECTION 7-3	CATALOGUE NUMBERS FOR MILLI-Q ADVANTAGE A10 SYSTEM	90

CHAPTER 1 INTRODUCTION

Section 1-1 PURPOSE OF THIS USER MANUAL

This User Manual is intended for use with a Milli-Q® Advantage A10 Water Purification System.

This User Manual is a guide for use during the installation, normal operation and maintenance of a Milli-Q Advantage A10 Water Purification System. It is highly recommended to completely read this manual and to fully comprehend its contents before attempting installation, normal operation or maintenance of the Water Purification System.

If this User Manual is not the correct one for your Water Purification System, then please contact Millipore.

The term "Milli-Q Advantage A10 Water Purification System" is replaced by the term "Milli-Q System" for the remainder of this User Manual unless otherwise noted.

Section 1-2 ABOUT MILLIPORE

1-2.1 TELEPHONE

See the Business Card(s) on the inside cover of the User Manual binder.

1-2.2 INTERNET

The Millipore Internet site address can be used to submit a question to Millipore via electronic mail. The Millipore Internet site can be used to find addresses, telephone/fax numbers and other information.

Internet site address: www.millipore.com/bioscience

1-2.3 CONTACT INFORMATION FOUND ON THE MAIN DISPLAY

Contact information about Millipore can be found on the Main Display. See Section 4-10 (**CALL MILLIPORE**) for more information.

1-2.4 MANUFACTURING SITE

Millipore SAS

67120 Molsheim

FRANCE

CHAPTER 2 PRODUCT INFORMATION

Section 2-1 OVERVIEW OF THE MILLI-Q WATER SYSTEM

2-1.1 MILLI-Q SYSTEM CABINET

Milli-Q System Cabinet



Input or output connections

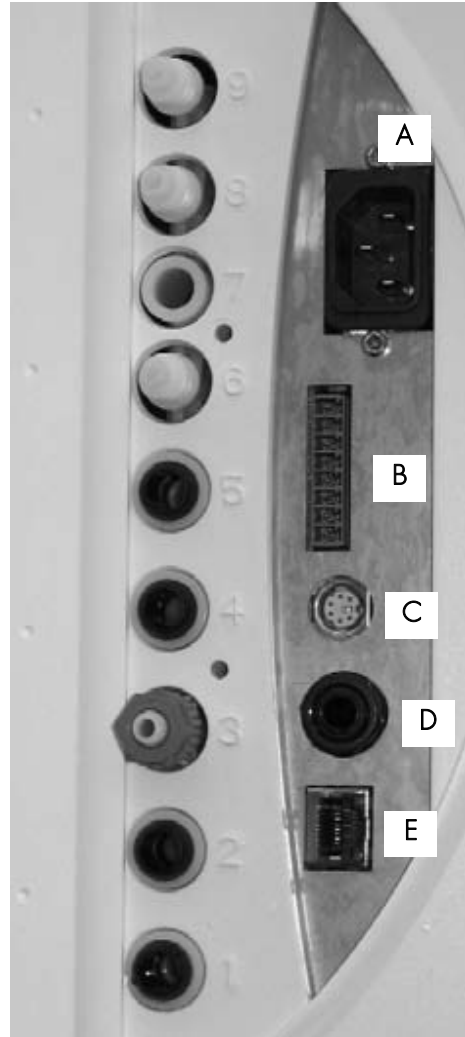

1	Not Used	A	Power Entry (100 – 240 VAC)
2	Feedwater Port	B	Accessories Power (maximum 24 VDC)
3	Water to Q-POD Dispenser	C	PS/2 Connection (maximum 5 VDC)
4	Water from Q-POD Dispenser	D	Level Sensor Input (maximum 5 VDC)
5, 6, 7, 8, 9	Not Used	E	Ethernet Connection (maximum 5 VDC)

2-1.2 Q-POD DISPENSER

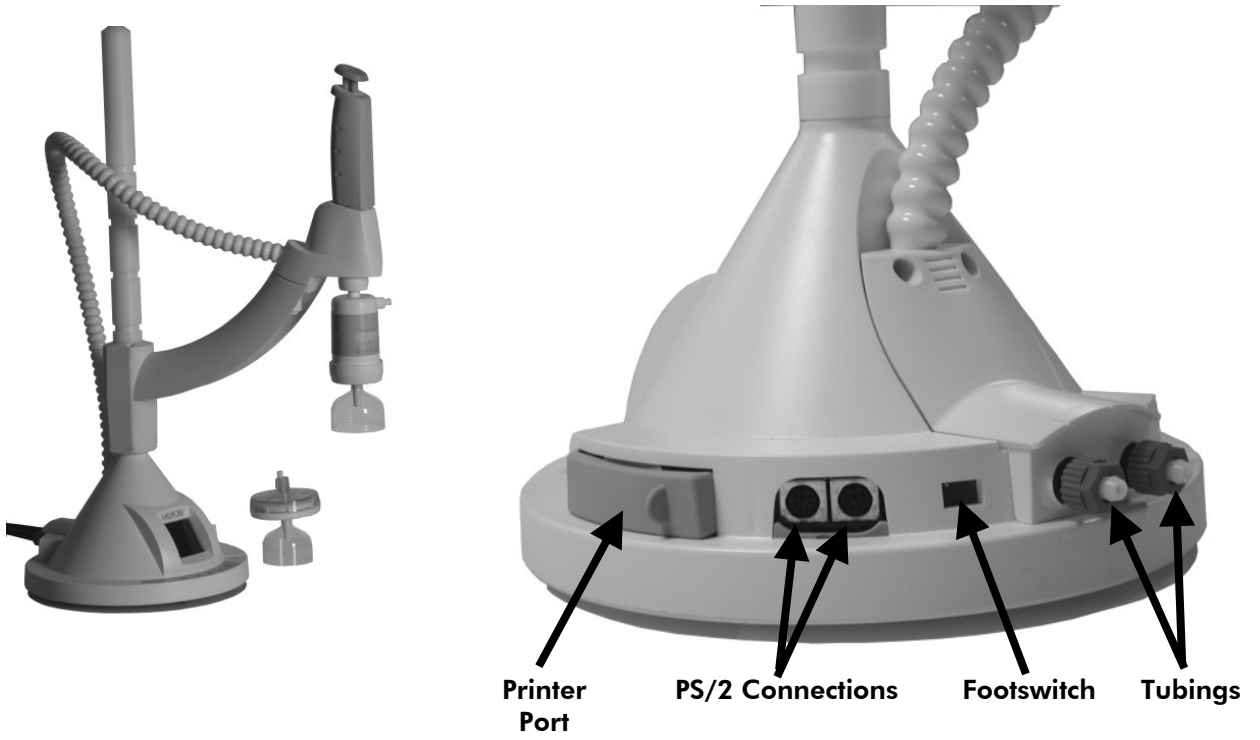

2-1.3 RC-LINK

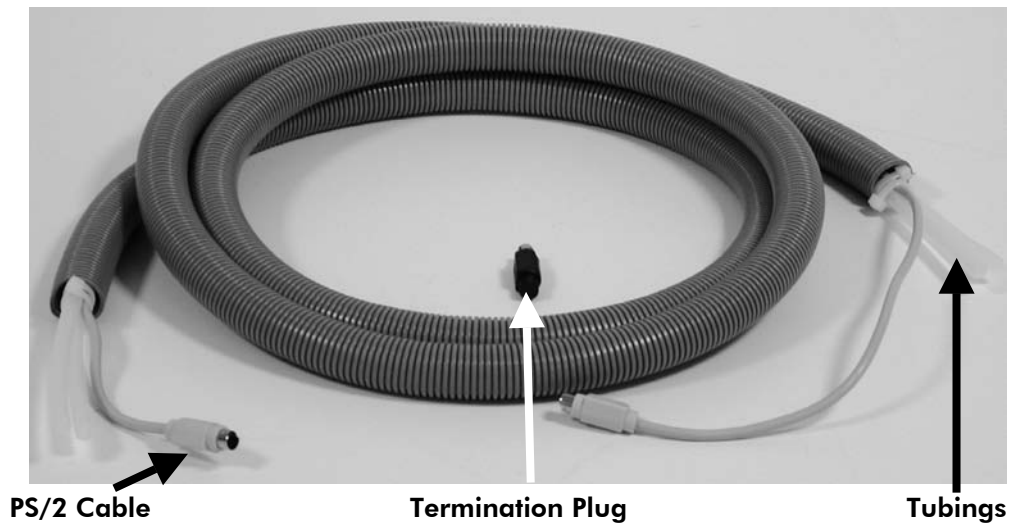

Section 2-2 MILLI-Q® WATER SPECIFICATIONS

FLOWRATES (FROM Q-POD DISPENSER 1)

- 0.05 Lpm – 2.0 Lpm

RESISTIVITY

- 18.2 MΩ.cm @25°C

CONDUCTIVITY

- 0.055 μS/cm @25°C

PYROGENS

- < 0.001 Eu/ml with BioPak™ Ultrafilter

PARTICLES

- ≤ 1/ml (particle size > 0.22 μm) with Millipak® Express 40 Filter or BioPak Ultrafilter

TOC

- < 5 ppb

This specification came from test conditions where a Milli-Q System was fitted with a Q-Gard® T1 Pack and a Quantum™ TEX Cartridge and the feedwater came from a Millipore RiOs™ Water System. The feedwater TOC value was < 50 ppb. The TOC of the Milli-Q Water can vary as a function of the feedwater TOC.

MICRO-ORGANISMS

- ≤ 1 CFU/ml with Millipak Express 40 Filter or BioPak Ultrafilter

RNASE AND DNASE

- RNase < 0.01 ng/mL with BioPak Ultrafilter
- DNase < 4 pg/μL with BioPak Ultrafilter

Section 2-3 FLOW SCHEMATIC

2-3.1 DIAGRAM

The water flow through a Milli-Q System is shown here in a flow diagram. A description of each item is in Section 2-3.2.

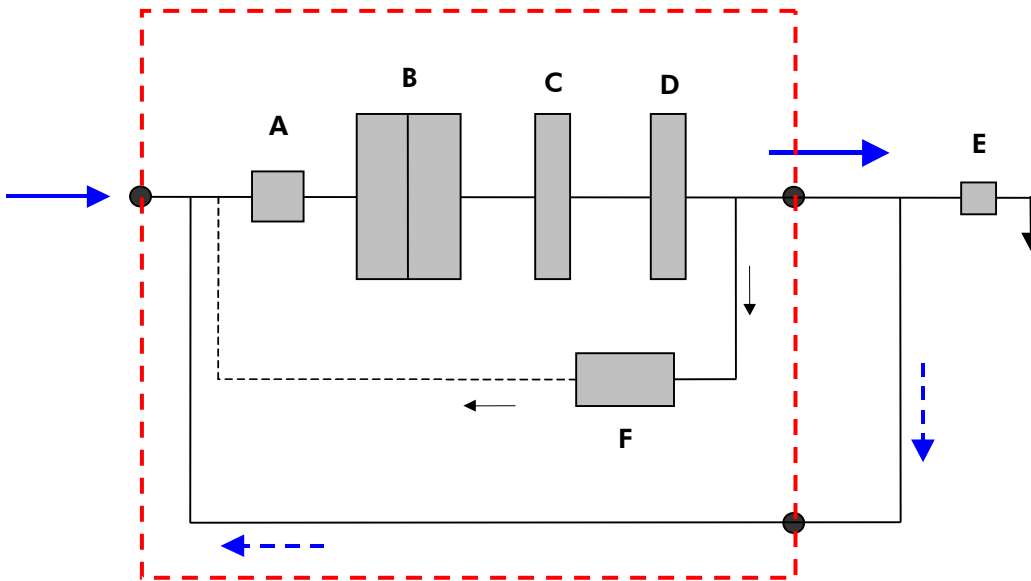

ITEM	DESCRIPTION	ITEM	DESCRIPTION
A	Pump	D	Quantum Cartridge
B	Q-Gard Purification Pack	E	POD Pak
C	UV 185 nm Lamp	F	A10 TOC Monitor

2-3.2 DESCRIPTION OF FLOW SCHEMATIC

The flow schematic is a simplified drawing of all the major components in a Milli-Q System.

Q-GARD PURIFICATION PACK

The Q-Gard Purification Pack is used to remove ions and organic molecules from the feedwater. The term "Q-Gard Pack" replaces "Q-Gard Purification Pack" for the remainder of this User Manual unless otherwise noted.

The Q-Gard Pack is a consumable. A consumable is something that is periodically changed out for a new one during the maintenance of the Milli-Q System.

There are different types of Q-Gard Packs. The use of each Q-Gard Pack is dependent upon the type of feedwater.

- **Q-GARD T1 PACK**

The Q-Gard T1 Pack is used when the feedwater comes from RO, distillation or Electrodeionisation (EDI). An example of RO or EDI feedwater is the water coming from either a Millipore RiOs System or Elix[®] Water Purification System. This type of feedwater typically has some ions but contains little organic, particulate and colloidal contamination.

- **Q-GARD T2 PACK**

The Q-Gard T2 Pack is used whenever the feedwater comes from a source other than mentioned above. The same feedwater would have a Fouling Index ≤ 5 .

- **Q-GARD T3 PACK**

The Q-Gard T3 Pack is used instead of a Q-Gard T2 Pack whenever the feedwater has a Fouling Index > 5 .

UV 185 NM LAMP

The dual wavelength UV 185 nm Lamp emits light at 185 nm (for TOC reduction) and at 254 nm (Germicidal action). The UV 185 nm Lamp is used to kill bacteria and to reduce the levels of organic molecules in the water.

The UV 185 nm Lamp is a consumable.

QUANTUM CARTRIDGE

The Quantum Cartridge is used to remove trace levels of ions and organic molecules.

The Quantum Cartridge is a consumable.

- **QUANTUM TIX CARTRIDGE**

The Quantum TIX Cartridge contains only ion exchange resin. This type of Quantum Cartridge is used when maintaining absolutely trace levels of ions is critical.

- **QUANTUM TEX CARTRIDGE**

The Quantum TEX Cartridge contains ion exchange resin and synthetic carbon. These purification media are used when the Milli-Q Water needs to have both trace levels of ions and trace levels of organic molecules.

A10 TOC MONITOR

The A10 TOC Monitor measures the Total Oxidizable Carbon (TOC) of the Milli-Q Water.

The A10 TOC Monitor uses a small lamp during its TOC Analysis Mode. This is called the A10 Lamp.

The A10 Lamp is a consumable.

POD PAK

The POD Pak is a water purification device that is attached to the Q-POD Dispenser outlet. It is the final purification device used before Milli-Q Water is dispensed. The POD Pak provides additional quality and insurance that trace contaminants related to specific applications are removed just before ultrapure water is delivered.

The POD Pak is a consumable.

The LCD messages sometimes refer to POD Pak 1 or POD Pak 2 (or 3). POD Pak 1 means the POD Pak on the 1st Q-POD Dispenser. POD Pak 2 refers to the POD Pak installed on a second Q-POD Dispenser.

- **MILLIPAK EXPRESS 40 FILTER**

The Millipak Express 40 Filter is a type of POD Pak. The Millipak Express 40 Filter is a membrane-based filter that removes all particles and bacteria with a size greater than 0.22 μm by a sieving mechanism. All contaminants larger than the filter pore size are retained on its surface. This blocks and retains any bacteria in the water passing through it.

- **BIOPAK ULTRAFILTER**

The BioPak Ultrafilter is a type of POD Pak. The BioPak Ultrafilter removes bacteria, nucleases (RNases, DNases) and Endotoxins (Pyrogens) from the Milli-Q Water.



Section 2-4 TECHNICAL SPECIFICATIONS

2-4.1 DIMENSIONS

MILLI-Q CABINET

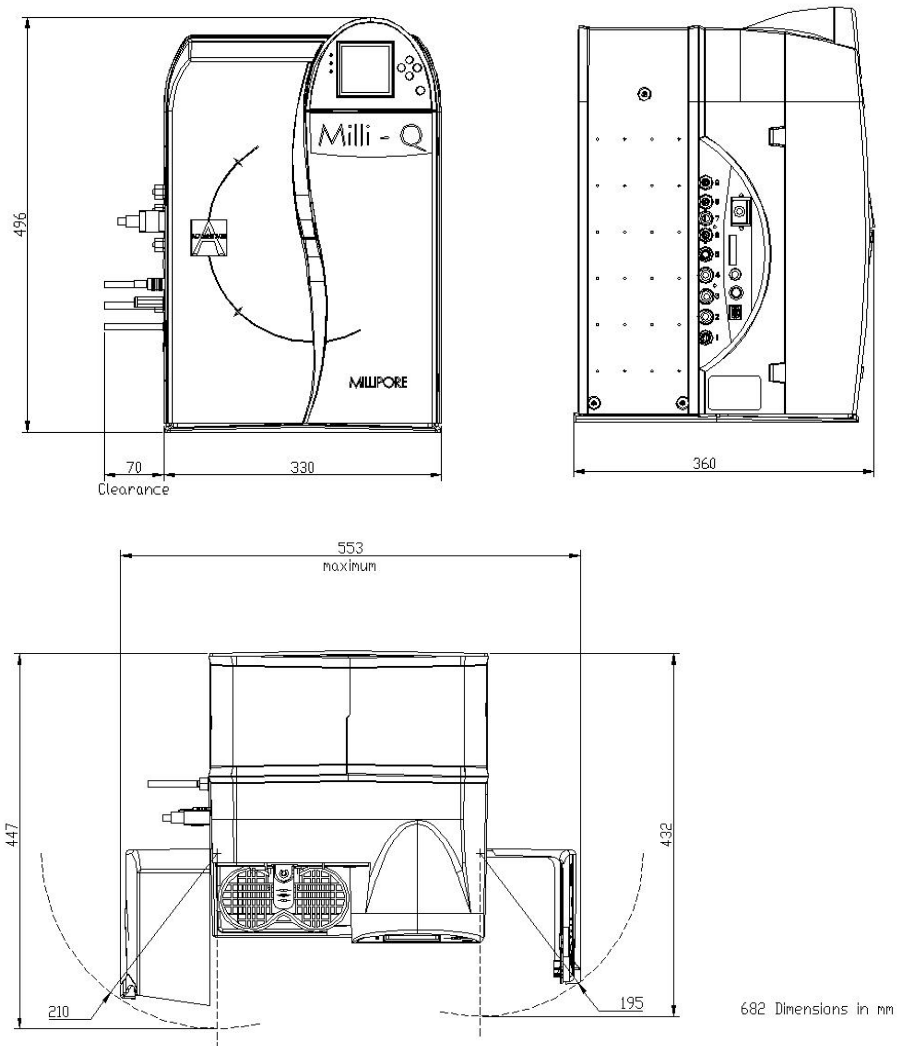

Q-POD DISPENSER

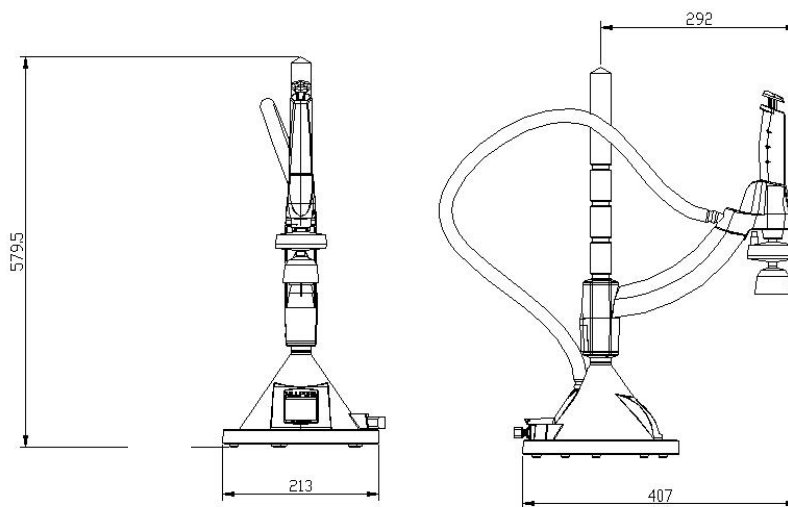

2-4.2 WEIGHT

ITEM	SHIPPING WEIGHT	DRY WEIGHT	WET WEIGHT
Milli-Q System Cabinet (no Q-POD Dispenser)	17.0 kg	13.0 kg	19.0 kg
Q-POD Dispenser	7.2 kg	4.7 kg	4.7 kg

2-4.3 ELECTRICAL

- Power source voltage 100-230 V ±10%
- Power used 160 VA
- Power source frequency range 50-60 Hz ±10%
- Power Entry Module Fuse 2.5 Amp Fast Acting; 5 mm x 20 mm; 250 V Safety Voltage; Millipore Spare Part Number FTPF07054. The fuse should be serviced by a qualified Millipore Service Representative.
- Earth Ground The power source must be earth grounded.
- Power Cord The Power Cord should be plugged into a wall outlet that is accessible. The Milli-Q System is powered on and off by removing the power cord from the wall outlet.
- Maximum distance from power source to Milli-Q System 2.5 meters

2-4.4 DISPLAYED VALUE RANGES

- Resistivity displayed value range 2 MΩ.cm – 18.2 MΩ.cm @25°C
- Conductivity displayed value range 1 μS/cm – 0.055 μS/cm @25°C
- Temperature displayed value range 0°C – 50°C
- TOC displayed value range 1 ppb – 999 ppb
- Flowmeter displayed value range 0.5 Lpm – 3 Lpm

2-4.5 MATERIALS OF CONSTRUCTION

Please contact Millipore for a list of the Materials of Construction.

2-4.6 NOISE LEVEL

Noise level = 47 dB at a distance of 1 meter.

CHAPTER 3 INSTALLATION

Section 3-1 INSTALLATION REQUIREMENTS

3-1.1 CONSUMABLES

The consumables needed for installation are listed below. Please note that these items are not included with the Milli-Q System. A Milli-Q System is comprised of a Milli-Q System Cabinet, a Q-POD Dispenser with RC-Link.

In addition to the Milli-Q System, you need:

- 1 Q-Gard Pack
- 1 Quantum Cartridge
- 1 POD Pak (Millipak Express 40 Filter or BioPak Ultrafilter)

3-1.2 SPACE

See Section 2-4.1 for dimensional information. The installation area needs to accommodate the total operating space of the Milli-Q System.

3-1.3 WEIGHT

See Section 2-4.2 for weight information. The installation area needs to accommodate the total operating weight of the Milli-Q System.

3-1.4 ELECTRICAL

See Section 2-4.3 for electrical information. The electrical supply needs to meet the stated electrical specifications.

3-1.5 FEEDWATER

TYPE OF FEEDWATER REQUIRED

- Pre-treated water including one or several of the following technologies: RO; RO + EDI; RO + DI; Distillation; DI.

FEEDWATER PHYSICAL REQUIREMENTS

- | | |
|--|------------------------------|
| ▪ Flowrate | > 2 lpm |
| ▪ Pressure range | 0.0 – 0.3 bar |
| ▪ Connection thread size and connection type | 1/2 inch male GAZ (BSP, NPT) |
| ▪ Feedwater tubing OD | 8 mm OD |
| ▪ Feedwater tubing maximum length | 2 meters |

FEEDWATER CHEMISTRY REQUIREMENTS

- | | |
|-----------------------|-------------------|
| ▪ Temperature range | 5°C – 35°C |
| ▪ pH range | 4 - 10 |
| ▪ Conductivity range | < 100 µS/cm @25°C |
| ▪ Fouling Index | < 5 |
| ▪ TOC (maximum value) | < 50 ppb |

3-1.6 ENVIRONMENTAL

AMBIENT TEMPERATURES

- Ambient storage temperature range 4°C – 40°C
- Ambient operation temperature range 4°C – 40°C

OTHER ENVIRONMENTAL REQUIREMENTS

- Location The Milli-Q System is intended for indoor use only.
- Relative Humidity during storage and operation Maximum relative humidity 80% for temperatures up to 31°C decreasing linearly to 50% relative humidity at 40°C.
- Altitude < 3000 meters
- Pollution Degree 2
- Installation Category II

Section 3-2 ASSEMBLING THE Q-POD DISPENSER

1. Open the Q-POD Dispenser box.
2. Locate the Q-POD Base and the Q-POD Mast. Screw them together. See the photograph below.
3. Locate the Q-POD Arm. Press on the locking handle and slide the Q-POD Arm onto the Q-POD Mast. Note that the height can be adjusted up or down.

Q-POD Mast to Q-POD Base with bolt.

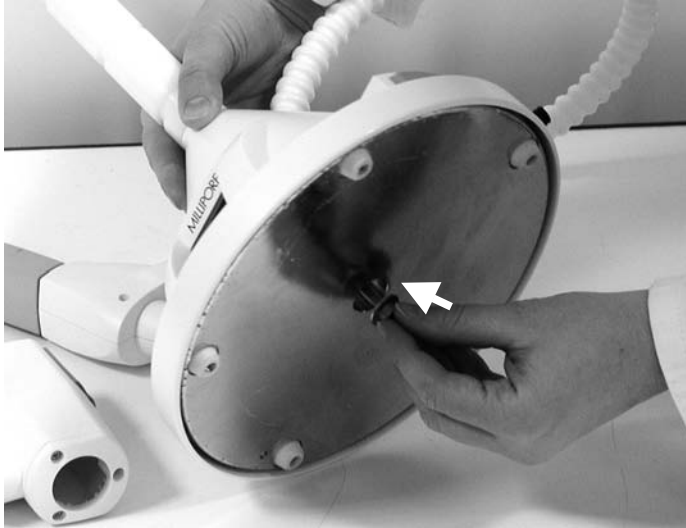

Q-POD Arm being put on Q-POD Mast.

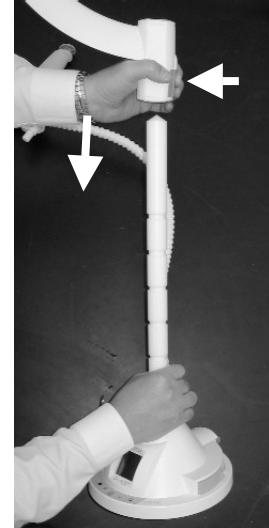

Q-POD Dispenser on Q-POD Arm.

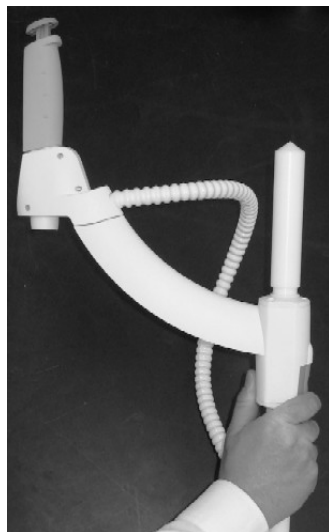

Section 3-3 CONNECTING THE Q-POD DISPENSER TO THE MILLI-Q SYSTEM CABINET

3-3.1 CONNECTING THE RC-LINK TO THE Q-POD DISPENSER



The Q-POD Dispenser installation instructions in this User Manual are written for the case of one Q-POD Dispenser being connected to the Milli-Q System Cabinet. If the Milli-Q System Cabinet is going to have two or three Q-POD Dispensers, then refer to the Insert document supplied with the Q-POD Dispenser.

Locate the RC-Link in the Q-POD Dispenser Accessories Bag. The RC-Link consists of a PS/2 cable with two lengths of tubing. The cable and the tubing lengths are enclosed in a sheath. The RC-Link is 2.5 metres in length. The cable terminates on each end with a PS/2 connection.

RC-LINK TUBING CONNECTIONS TO THE Q-POD BASE

1. Locate the two tubing ports on the back of the Q-POD Dispenser Base. See the illustrations below.
2. Unscrew the 2 nuts from the Q-POD Dispenser ports.



Either end of the RC-Link can be attached to the Q-POD Dispenser.

3. Connect the RC-Link tubing to the Q-POD Dispenser Ports.

RC-LINK CABLE CONNECTION TO THE Q-POD BASE

1. Locate the Termination Plug (small electronic device) that came in the Q-POD Dispenser Accessories Bag. Plug this into one PS/2 connection on the Q-POD Base.



When the Milli-Q System Cabinet is connected to one Q-POD Dispenser, both PS/2 connections are used on the Q-POD Base. One connection is used with the RC-Link cable. The other connection is used for the Termination Plug.

2. Plug the RC-link cable in the other PS/2 connection on the Q-POD Base.



The RC-Link cable can be plugged into either PS/2 connection on the Q-POD Dispenser Base.

Q-POD Base without RC-Link attached.



RC-Link tubing being attached to one port on Q-POD Base.

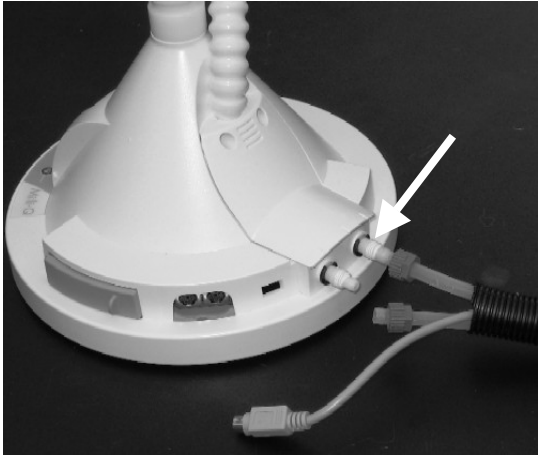

RC-Link tubing attached to 2nd port on Q-POD Base.

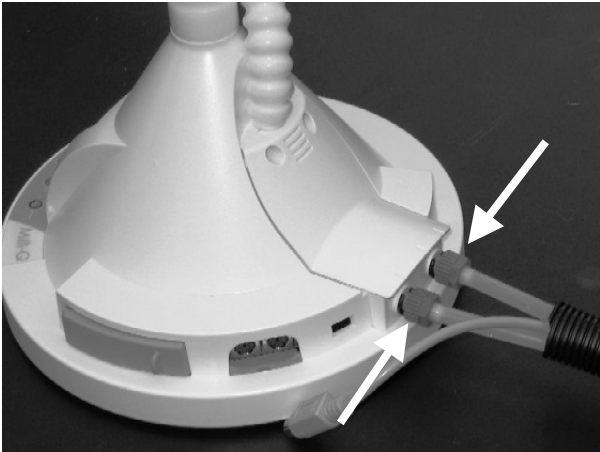

PS/2 Cable from RC-Link attached to Q-POD Base.

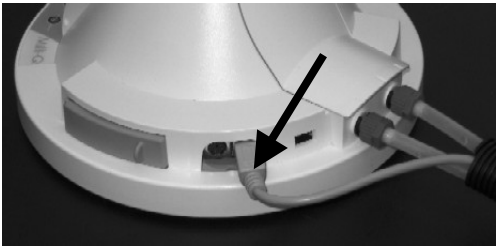

Termination Plug attached to Q-POD Base.

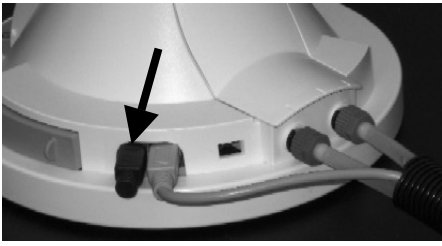

3-3.2 CONNECTING THE RC-LINK TO THE MILLI-Q SYSTEM CABINET

RC-LINK TUBING CONNECTIONS TO THE MILLI-Q SYSTEM CABINET

1. Locate Port 3 and Port 4 on the Milli-Q System Cabinet.
2. Plug one length of tubing from the RC-Link into Port 4. When the tubing is pushed in, pull on it to make sure it is securely fastened.



The Q-POD Dispenser design allows for either length of RC-Link tubing to be connected to Port 4 on the Milli-Q System Cabinet.

3. Plug the other length of tubing into Port 3. This Port uses a nut to secure the tubing to a plastic stem. Unscrew the nut from Port 3. Push the end of the tubing through the nut. Push this end of the tubing onto the plastic stem. Screw the nut.



Make sure the RC-Link tubing lengths are connected to Port 3 and to Port 4. Do not connect the RC-Link tubing to any other ports on the Milli-Q System Cabinet.

RC-LINK CABLE CONNECTION TO THE MILLI-Q SYSTEM CABINET

1. Locate the PS/2 connection on the Milli-Q System Cabinet. It is located below where the Power Cord plugs in.
2. Plug the RC-link PS/2 cable into the Milli-Q System Cabinet.



Make sure all PS/2 connections (cable and termination plug) are pushed in completely.

Milli-Q System Cabinet without RC-Link connected.



PS/2 Cable connected to Milli-Q System Cabinet.

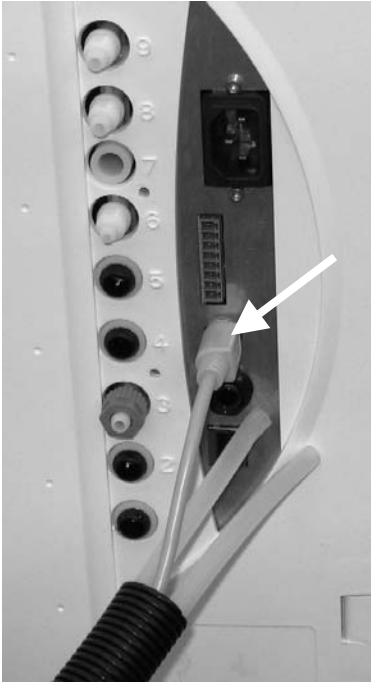

RC-Link tubing to Port 4.

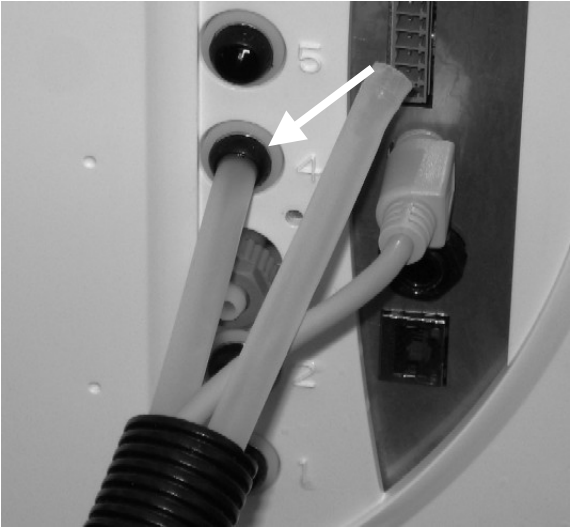

RC-Link tubing to Port 3.

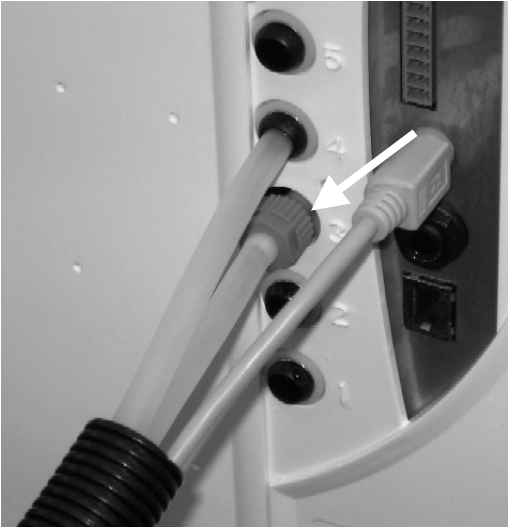

Section 3-4 FEEDWATER CONNECTION TO THE MILLI-Q SYSTEM CABINET

3-4.1 FROM A RESERVOIR

1. Make sure the Milli-Q System Cabinet is located either beside or lower than the Reservoir. It is not recommended to locate the Reservoir below the Milli-Q System Cabinet.
2. Measure the distance between the Reservoir and the left side of the Milli-Q System. Allow some extra distance so the Milli-Q System could be rotated or moved without stretching the tubing. Cut an appropriate sized length of tubing.
3. Install one end of this tubing to the Reservoir.
4. See Section 3-4.3.

3-4.2 FROM A LOOP

1. Locate the roll of white tape and the 8 mm tubing (plus Inlet Strainer assembly) from the Accessories Bag. Make sure that the uses a 1/2 inch GAZ (or BSPM or NPTM) connection.
2. Wind about 3 to 4 turns of white tape on the Loop connection. The tape should be wound in a clockwise direction (same direction the fittings are turned).
3. Attach the Inlet Strainer assembly to the Loop connection.
4. Measure the distance needed for the feedwater tubing. This is the distance between the Inlet Strainer and the left side of the Milli-Q System. Allow some extra distance so the Milli-Q System could be rotated or moved without stretching the tubing.
5. Cut the appropriate length of 8 mm tubing as determined above.
6. Now install a feedwater pressure regulator. Turn it over to see the arrow that indicates the direction of water flow through the Pressure Regulator. **It is important not to reverse the water flow through the Pressure Regulator.**
7. The Pressure Regulator is installed between the Inlet Strainer (now attached to the pipe end) and the Milli-Q System.
8. Normally, the Millipore Pressure Regulator is pre-set to 0.1 bar and does not need adjustment.



The setting of the Pressure Regulator should not exceed 0.3 bar while the Milli-Q System is dispensing water at maximum flow.

3-4.3 CONNECTION OF FEEDWATER TUBING TO THE MILLI-Q SYSTEM CABINET

1. Turn off the feedwater.
2. Locate Port 2 on the Milli-Q System Cabinet.
3. Connect the feedwater tubing to Port 2 on the Milli-Q System Cabinet. Make sure the tubing is securely fastened.



Make sure the feedwater tubing is connected to Port 2. Do not connect the feedwater tubing to any other port on the Milli-Q System Cabinet.

4. Turn on the feedwater.

Feedwater tubing attached to Port Number 2.



Section 3-5 QUICK REFERENCE GUIDE

1. Open the left door of the Milli-Q System Cabinet.
2. Locate the two elastic bands attached to the inside of this door.
3. Place the Quick Reference Guide here.

Quick Reference Guide location.

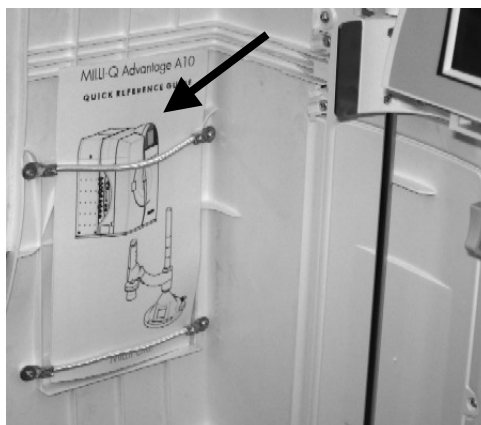

Section 3-6 MILLI-Q SYSTEM IS POWERED ON



3-6.1 POWER CORD INSTALLATION

1. Locate the electrical power receptacle on the Milli-Q System Cabinet.
2. Plug the power cord into the Milli-Q System Cabinet.

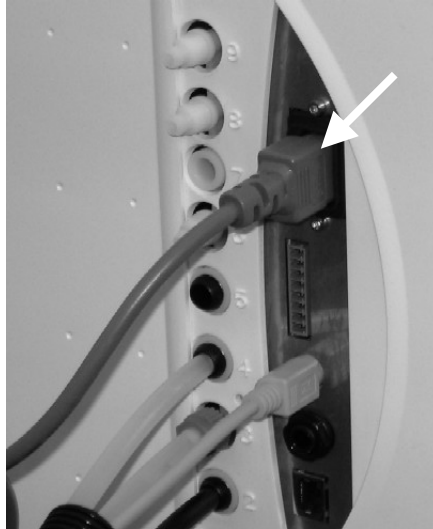

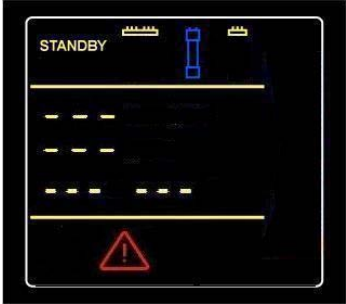
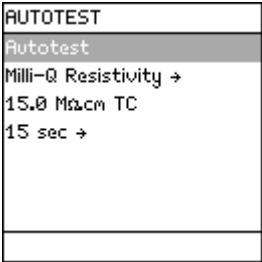
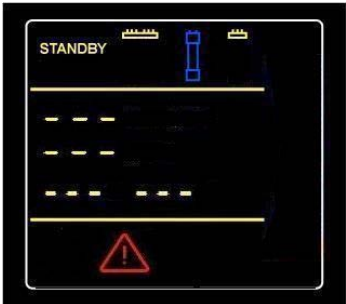

Power cord plugged into Milli-Q System Cabinet.

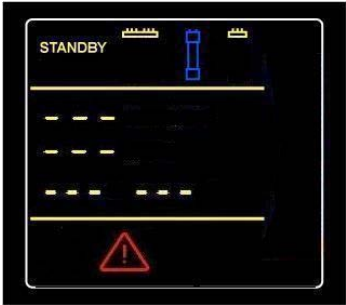

3-6.2 DISPLAYS SHOWN WHEN THE MILLI-Q SYSTEM IS POWERED ON

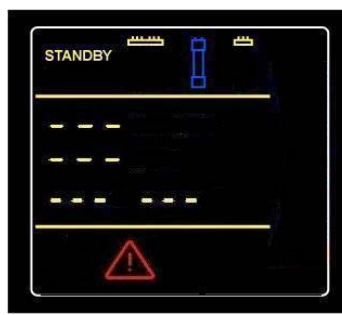
Description	Main Display	Q-POD Display
<p>1. The Milli-Q System is now powered.</p> <p>2. The Milli-Q System displays a TESTING LCD and an INTEGRITY CHECK LCD for several seconds.</p> <p>3. The Q-POD displays POD 1 during this time.</p> <p>4. The Main Display and the Q-POD Display look like the LCDs shown to the right. Note that your Milli-Q System may have a different Serial Number, Manufacturing Date (MFG Date) and Installation Date (Inst Date) than shown here.</p>	 <pre> MILLIPORE Milli-Q Advantage A10 Cat N°: Z0000U0T0 Serial N°: F6DN27327B MFG Date: 1 Oct 2005 Inst Date: 20 Oct 2005 15 sec → </pre>	
<p>5. An AUTOTEST is now being done.</p>	 <pre> AUTOTEST Autotest Milli-Q Resistivity → 15.0 MΩcm TC 15 sec → </pre>	
<p>6. Because the Q-Gard Pack (and the Quantum Cartridge) are not installed, the LCD look like this.</p> <p>7. At this time, do not scroll to the right. Do not press the Keypad buttons at this time.</p>	 <pre> STANDBY 01 Feb 2006 23:24 Q-GARD PACK OUT PRESS → </pre>	

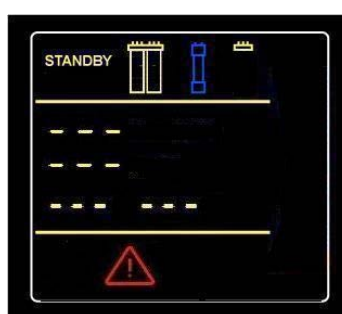
Section 3-7 Q-GARD PACK INSTALLATION

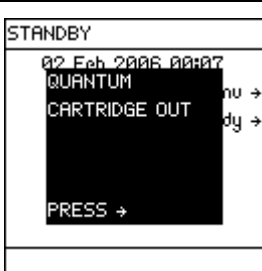
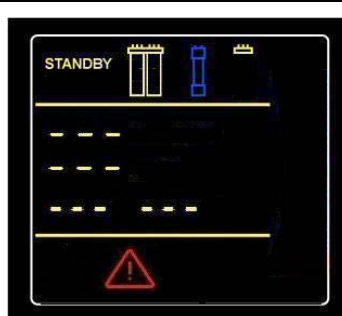
<ol style="list-style-type: none"> 1. Open the left door of the Milli-Q System Cabinet. 2. Locate the small plastic plugs used to protect the ports where the Q-Gard Pack is installed. Remove these plugs. 3. Move the Pack Locking Handle up. 4. Remove the new Q-Gard Pack from its shipping box. 5. Remove the plastic covers on the 2 ports of the Q-Gard Pack. Look inside the ports to locate the black rubber O-rings. Make sure these are firmly in-place. 6. Wet the O-rings with water. 		
<ol style="list-style-type: none"> 7. See the photographs on the next page as a guide. 8. Push in the top of the Q-Gard Pack until it stops. Push in on the bottom of the Q-Gard Pack and hold. 9. The Milli-Q System now recognises that the Q-Gard Pack is installed. See the LCD to the right. Note that the Catalogue Number and the Lot Number may be different. 10. Push the Pack Locking Handle down. If it doesn't go down easily, then make sure the top and the bottom of the Q-Gard Pack are pushed in. 11. Close the left door. 		
<ol style="list-style-type: none"> 12. Press  on the Keypad. Since the Quantum Cartridge is not installed yet, the LCD looks like this. 13. At this time, do not scroll to the right. Do not press the Keypad buttons at this time. 14. See Section 3-8. 		

Plugs.



Q-Gard Pack location.



Pak Locking Handle lifted up.



Q-Gard Pack being pushed in at the top.





Q-Gard Pack pushed in at the bottom.



Pak Locking Handle being pushed down while holding the bottom of the Q-Gard Pack.

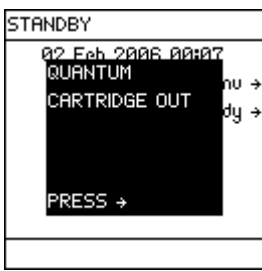
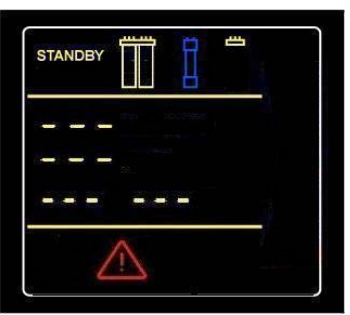
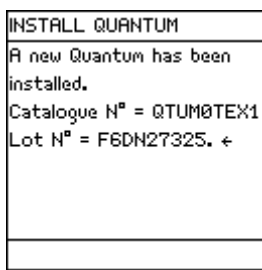
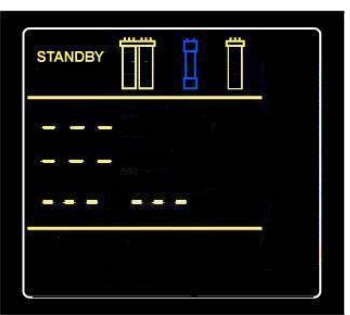

Section 3-8 QUANTUM CARTRIDGE INSTALLATION

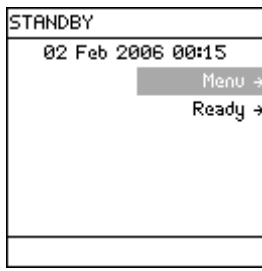
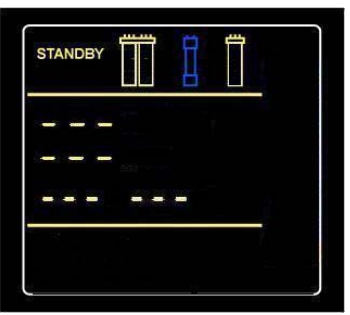
<ol style="list-style-type: none"> 1. Open the right door of the Milli-Q System Cabinet. 2. Locate the small plastic covers used to protect the ports where the Quantum Cartridge is installed. Remove these plugs. 3. Remove the Quantum Cartridge from its shipping box. 4. Remove the plastic covers on the 2 ports of the Quantum Cartridge. There should be O-rings on the middle and left ports as viewed from the front. The right port is not used and does not contain an O-ring. 5. Wet the 2 O-rings with water. 		
<ol style="list-style-type: none"> 6. Install the Quantum Cartridge until it is fully seated. See the photos on the next page. 7. The Milli-Q System recognises that the Quantum Cartridge is installed. See the LCD to the right. Note that the Catalogue Number and the Lot Number may be different. 8. Close the right door. 		
<ol style="list-style-type: none"> 9. Press  on the Keypad. The LCD looks like this. 		

Quantum Cartridge being placed into pack adapter.



Top of Quantum Cartridge being pushed into place



Quantum Cartridge installed.



Section 3-9 RINSING THE MILLI-Q

3-9.1 INSTALLATION OF BARBED FITTING AND CLEAR TUBING

1. Locate the clear tubing and the barbed fitting from the Milli-Q System Accessories Bag.
2. Screw the barbed fitting onto the Q-POD Dispenser.



Do not use any white tape on the threads of the barbed fitting. An O-ring is located inside the Q-POD Dispenser.

3. Push one end of the clear tubing onto the end of the barbed fitting. Place the other end of the clear tubing into a sink.

3-9.2 PURGING AIR FROM THE MILLI-Q SYSTEM

1. At this time you should have installed the Q-Gard Pack, the Quantum Cartridge, the barbed fitting and the clear tubing. The Milli-Q System should be powered. The Main Display and the Q-POD Dispenser should be in **READY Mode**. See Section 4-3 to see how to go from **STANDBY Mode** to **READY Mode**.
2. Verify that you have several Litres of feedwater (i.e. full Reservoir).
3. Push the plunger down on the Q-POD Dispenser. See Section 4-4.1.
4. In a few minutes, water should dispense from the Q-POD Dispenser.
5. Dispense water for about 10 minutes. This flushes out any trapped air in the Milli-Q System. This also rinses off the purification media located in the Q-Gard Pack and the Quantum Cartridge.
6. Push the Q-POD Dispenser Plunger again to stop dispensing water. See Section 4-4.1.

3-9.3 HYDRATING THE MILLI-Q SYSTEM

1. At this time, the POD Pak should not be installed. The barbed fitting and the clear tubing should still be attached to the end of the Q-POD Dispenser.
2. **Leave the Milli-Q System in READY Mode overnight or for several hours (> 6 hours).** Do not leave the Milli-Q System in **STANDBY Mode**. This allows the purification media in the Q-Gard Pack and Quantum Cartridge to hydrate.
3. Afterwards, dispense water for about 10 minutes.
4. **Leave the Milli-Q System in READY Mode when finished.**

Q-POD Dispenser with barbed fitting and clear tubing. Water is about to be dispensed.



Section 3-10 A10 TOC MONITOR CLEANING

The A10 TOC Monitor should be cleaned when the Milli-Q System is installed. Go to Section 5-7 and follow the instructions about cleaning the A10 TOC Monitor.

Section 3-11 INSTALLATION OF THE POD PAK

3-11.1 INSTALLING AND RINSING THE MILLIPAK EXPRESS 40 FILTER

There are two things that need to be done when installing a Millipak Express 40 Filter. First, the Millipak Express 40 Filter needs to be installed on the Q-POD Dispenser. Secondly, you need to register a Millipak Express 40 Filter installation. See Section 3-12 for information on how to register a POD Pak (Millipak Express 40 Filter or BioPak Ultrafilter) installation.

1. Remove the clear tubing and the barbed fitting from the Q-POD Dispenser.
2. There is an O-ring inside the Q-POD Dispenser. Make sure the O-ring remains in-place and does not come out.
3. Remove the new Millipak Express 40 Filter from its packaging.



ATTENTION

Do not use any white tape on the threads of the Millipak Express 40 Filter. An O-ring is located inside the Q-POD Dispenser.

4. Screw the Millipak Express 40 Filter onto the Q-POD Dispenser. **Do not overtighten it.**
5. Place the Milli-Q System into **READY** Mode. Dispense water. Slightly open the vent on the top of the Millipak Express 40 Filter to remove air. Close the vent afterwards.
6. **Dispense water for 5 minutes to flush out the Millipak Express 40 Filter.**

Millipak Filter installed on a Q-POD Dispenser.

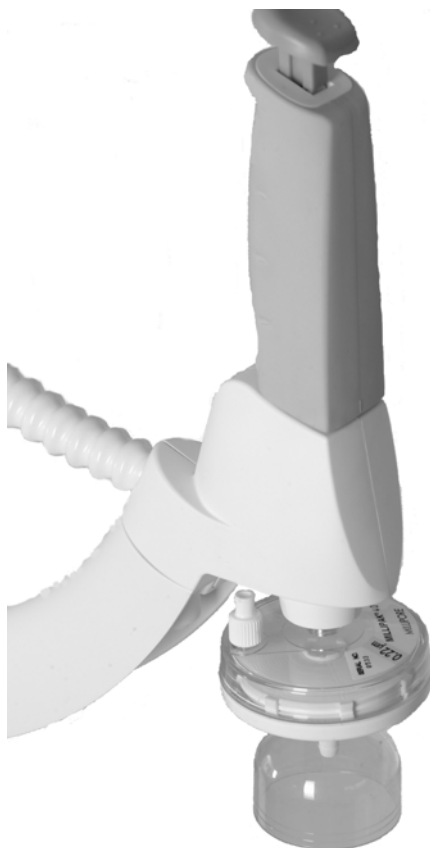

3-11.2 INSTALLATION AND RINSING OF THE BIOPAK ULTRAFILTER

There are two things that need to be done when installing a BioPak Ultrafilter. First, the BioPak Ultrafilter needs to be installed on the Q-POD Dispenser. Secondly, you need to register a BioPak Ultrafilter installation. See Section 3-12 for information on how to register a POD Pak (Millipak Express 40 Filter or BioPak Ultrafilter) installation.

1. Remove the clear tubing and the barbed fitting from the Q-POD Dispenser.
2. There should be an O-ring inside the Q-POD Dispenser. Make sure the O-ring remains in-place and does not come out.









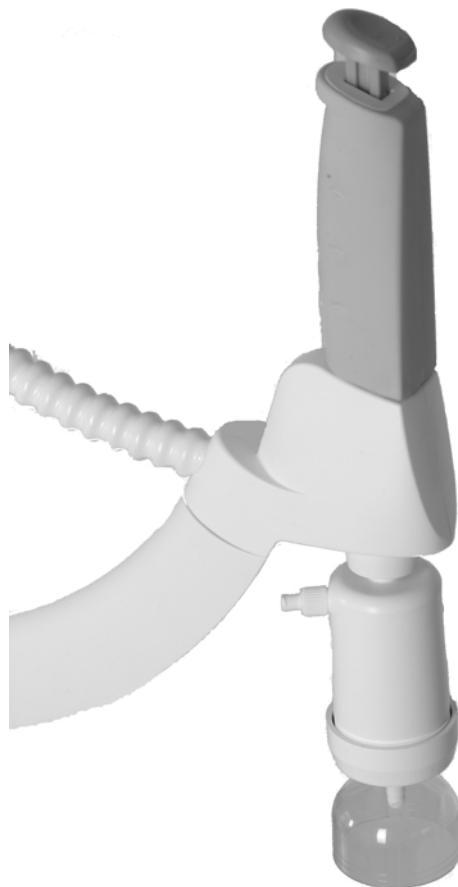







Do not use any white tape on the threads of the BioPak Ultrafilter.
An O-ring is located inside the Q-POD Dispenser.

3. Take the BioPak Ultrafilter auto adhesive label and fill it out with a permanent pen. Indicate the date of installation and the future replacement date (90 days later). Peel off the label and attach it on the BioPak Ultrafilter.
4. Screw the BioPak Ultrafilter onto the Q-POD Dispenser.
5. Dispense water. Slightly open the vent on the top side of the BioPak Ultrafilter to remove air. Close the vent afterwards.
6. **Dispense water for 10 minutes to flush out the BioPak Ultrafilter.**

BioPak Ultrafilter installed on a Q-POD Dispenser.











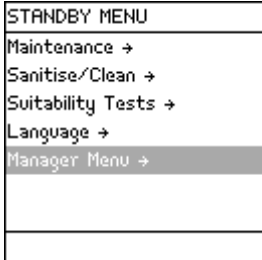





Section 3-12 HOW TO REGISTER A POD PAK BEING INSTALLED

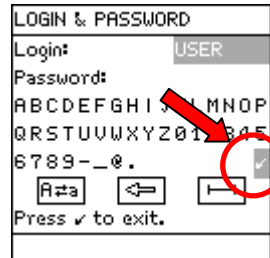



	<p>Select Menu. Press</p>			<p>Select Maintenance. Press</p>	
	<p>Select Install POD Pak 1 (if installing on Q-POD Dispenser 1). Press</p>			<p>Press</p>	
	<p>Press</p>			<p>Select the type of POD Pak you are installing.</p>	
<p>Press</p>			<p>Press</p>		
<p>You have finished registering a POD Pak installation. In this example, the Milli-Q System reminds you in 182 Days to replace the POD Pak.</p>					

Section 3-13 HOW TO ENTER THE MANAGER MENU









The **Manager Menu** is a password-protected feature of the Milli-Q System Firmware. The **Manager Menu** is used to access features that are not used in day-to-day operation. Follow the instructions below to enter the **Manager Menu**.

	<p>Select Manager Menu. Press</p> 		<p>The default LOGIN is USER</p> <p>The default PASSWORD is PASS</p>
<p>Select the letter 'U' using the Keypad.</p> 	<p>Press</p> 	<p>If you need to change to the letter case or if you make a mistake, use the upper/lower case button or the backspace button. These are shown here.</p>	
<p>Repeat the steps above until the LOGIN (USER) is entered.</p>		<p>Select the tick on the LCD using the Keypad.</p> 	
<p>Press</p> 		<p>Now enter in the Password. The Password is PASS</p>	
<p>Select the tick on the LCD using the Keypad.</p> 	<p>Press</p> 		<p>You have entered the MANAGER MENU. Use Change ID and Pass if you want to change the LOGIN and PASSWORD from the default values.</p>

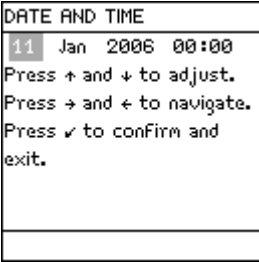
Section 3-14 SELECTING THE LANGUAGE

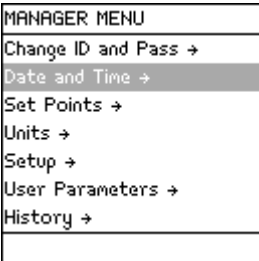
<p>STANDBY 02 Feb 2006 22:18 Menu → Ready →</p>	<p>Select Menu. Press</p>		<p>STANDBY MENU Maintenance → Sanitise/Clean → Suitability Tests → Language → Manager Menu →</p>	<p>Select Language. Press</p>		
<p>LANGUAGE French English ✓ German Japanese Portuguese Chinese Italian</p>	<p>Select the language you want.</p>	<p>Press</p>		<p>STANDBY MENU Maintenance → Sanitise/Clean → Suitability Tests → Language → Manager Menu →</p>	<p>Press</p>	

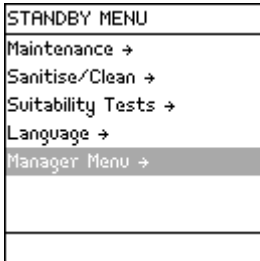

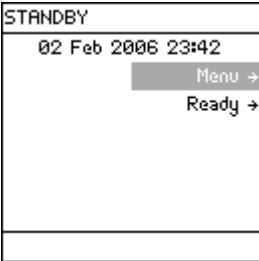



Section 3-15 SETTING THE DATE AND TIME

<p>Go to the MANAGER MENU. See Section 3-12 for information about how to enter the MANAGER MENU.</p>	<p>Select Manager Menu. Press</p> 		<p>Select Date and Time.</p> <p>Press</p> 
	<p>Use the instructions shown on the LCD.</p>		<p>Press</p> 
	<p>Press</p> 		<p>Press</p> 
			

Section 3-16 CALIBRATING THE MILLI-Q WATER FLOWRATE

The Milli-Q Water Flowrate should be calibrated when the system is installed. This calibration should be done with Q-POD Dispenser Number 1 in case there are multiple Q-POD Dispensers. You need a 1 Litre graduated cylinder before starting the Flow Calibration.





The Flow Calibration Software is accessed from the **MANAGER MENU** Mode. See Section 3-12 for information about accessing the **MANAGER MENU**.

<p>MANAGER MENU</p> <p>Change ID and Pass → Date and Time → Set Points → Units → Setup → User Parameters → History →</p>	<p>Select Setup. Press</p> 	<p>SETUP</p> <p>Buzzer → MQ Recirc Mode → POD Flow Stop → Temp Comp Mode → Flow Calibration → UV 185 nm Activation → Network Settings →</p>	<p>Select Flow Calibration. Press</p> 
<p>FLOW CALIBRATION</p> <p>Place a 1.0L graduated cylinder under the Q-POD outlet N°1. Press ✓ to start calibration, press ← to cancel.</p>	<p>After placing a graduated cylinder under Q-POD Dispenser Number 1, press</p> 	<p>FLOW CALIBRATION</p> <p>Press  on Q-POD base to start water delivery. After the water dispensing is complete, measure the collected volume.</p>	<p>Press</p> 
<p>FLOW CALIBRATION</p> <p>The system is now delivering water. Task Completion: 25 %</p>	<p>Water dispenses automatically from Q-POD Dispenser 1. Wait until the Task Completion is completed.</p>	<p>FLOW CALIBRATION</p> <p>The system is now delivering water. Task Completion: 0 %</p>	<p>FLOW CALIBRATION</p> <p>Volume = 900 mL Use + and - keys to register the value of the collected volume. Press ✓ to confirm and exit</p>
<p>Measure the amount of water (in ml) that was dispensed. Suppose 870 ml were collected. Input this using the Keypad.</p>	<p>FLOW CALIBRATION</p> <p>Volume = 870 mL Use + and - keys to register the value of the collected volume. Press ✓ to confirm and exit</p>	<p>Press</p> 	<p>SETUP</p> <p>Buzzer → MQ Recirc Mode → POD Flow Stop → Temp Comp Mode → Flow Calibration → UV 185 nm Activation → Network Settings →</p>
<p>Press 3 times on</p> 	<p>STANDBY</p> <p>02 Feb 2006 23:56</p> <p>Menu → Ready →</p>		

Section 3-17 CHANGING THE SET POINTS

Inside the **MANAGER MENU** is a section called **Set Points**. These are used to trigger the display of various Alerts or Alarms. The **Set Points** are summarised below.

3-17.1 EXAMPLE OF CHANGING A SET POINT

<p>MANAGER MENU</p> <ul style="list-style-type: none"> Change ID and Pass → Date and Time → Set Points → Units → Setup → User Parameters → History → 	<p>Select Set Points.</p> 	<p>SET POINTS</p> <ul style="list-style-type: none"> Milli-Q Inter Res → Milli-Q Product Res → Milli-Q Product TOC → Millipak → BioPak → Other POD Pak A → Other POD Pak B → 	<p>Suppose you want to change the Set Point for the Milli-Q Product TOC.</p>
<p>MILLI-Q PRODUCT TOC</p> <p>Milli-Q Product TOC Setpoint = 500 ppb Press ↑ and ↓ to adjust. Press ✓ to validate. Press ← to exit.</p>	<p>Press either</p>  	<p>MILLI-Q PRODUCT TOC</p> <p>Milli-Q Product TOC Setpoint = 50 ppb Press ↑ and ↓ to adjust. Press ✓ to validate. Press ← to exit.</p>	<p>When the Set Point is changed, press</p> 
<p>SET POINTS</p> <ul style="list-style-type: none"> Milli-Q Feed Cond → Milli-Q Inter Res → Milli-Q Product Res → Milli-Q Product TOC → Millipak → BioPak → Other POD Pak A → 	<p>Press</p> 	<p>MANAGER MENU</p> <ul style="list-style-type: none"> Change ID and Pass → Date and Time → Set Points → Units → Setup → User Parameters → History → 	

3-17.2 SUMMARY OF SET POINTS

MILLI-Q FEED COND

- **PURPOSE**

This set point is related to the maximum feedwater conductivity value. The feedwater to the Milli-Q System can be measured and displayed using an accessory device.

- **LCD MESSAGES RELATED TO THIS SET POINT**

If this value is exceeded, then the Alert **MILLI-Q FEED CONDUCTIVITY > SP** is displayed.

MILLI-Q INTER RES

- **PURPOSE**

This set point is related to the Intermediate Resistivity Sensor measurement. The Intermediate Resistivity Sensor is located between the Q-Gard Pack and the UV 185 nm Lamp. This set point is used to indicate that the resistivity of the post Q-Gard Pack water is decreasing.

- **LCD MESSAGES RELATED TO THIS SET POINT**

If the post Q-Gard Pack resistivity is measured below this set point, then the Alert **MILLI-Q INTER R < SP, PLEASE ORDER Q-GARD AND QUANTUM** is displayed.

MILLI-Q PRODUCT RES

- **PURPOSE**

This set point is used to indicate that the resistivity of the Milli-Q Water is decreasing.

- **LCD MESSAGES RELATED TO THIS SET POINT**

If the Milli-Q Water resistivity is measured below this set point, then the Alarm **MILLI-Q RES < SP, REPLACE Q-GARD AND QUANTUM** is displayed.

MILLI-Q PRODUCT TOC

- **PURPOSE**

This set point is used to indicate that the TOC of the Milli-Q Water is increasing.

- **LCD MESSAGES RELATED TO THIS SET POINT**

If the Milli-Q Water TOC is measured above this set point, then the Alarm **MILLI-Q TOC > SP** is displayed.

MILLIPAK

- **PURPOSE**

This set point is used to indicate that the Millipak Express 40 Filter should be changed.

- **LCD MESSAGES RELATED TO THIS SET POINT**

If the Millipak Express 40 Filter has been installed for x-14 Days (where x is the set point), then the Alert message **REPLACE POD PAK N°1 IN 14 DAYS** is shown. Note that this message could be displayed for POD PAK N°2 or POD PAK N°3 instead.

BIOPAK

- **PURPOSE**

This set point is used to indicate that the BioPak Ultrafilter should be changed.

- **LCD MESSAGES RELATED TO THIS SET POINT**

If the BioPak Ultrafilter has been installed for x-14 Days (where x is the set point), then the Alert message **REPLACE POD PAK N°1 IN 14 DAYS** is shown. Note that this message could be displayed for POD PAK N°2 or POD PAK N°3 instead.

OTHER POD PAK A (or B or C)

- **PURPOSE**

This set point is for a POD Pak other than a Millipak Express 40 Filter or a BioPak Ultrafilter. This set point is used to indicate that the POD Pak should be changed.





- **LCD MESSAGES RELATED TO THIS SET POINT**

If the POD Pak has been installed for x-14 Days (where x is the set point), then the Alert message **REPLACE POD PAK A IN 14 DAYS** is shown. Note that this message could be displayed for POD PAK B or POD PAK C instead.

Section 3-18 OTHER SETTINGS

3-18.1 UNITS

Inside the **MANAGER MENU** is a section called "Units". This is used to change the units of Milli-Q Water quality between $M\Omega.cm$ (units of resistivity) and $\mu S/cm$ (units of conductivity). In addition, the reservoir water level units can be changed here between % full, Litres and Gallons.

<p>MANAGER MENU</p> <ul style="list-style-type: none"> Change ID and Pass → Date and Time → Set Points → Units → Setup → User Parameters → History → 	<p>Select Units.</p> 	<p>UNITS</p> <ul style="list-style-type: none"> Milli-Q Product → Tank Volume → 	<p>Suppose you want to change the Units for the Milli-Q Product.</p>
<p>Press</p> 	<p>MILLI-Q PRODUCT</p> <ul style="list-style-type: none"> $M\Omega.cm$ ✓ $\mu S/cm$ 	<p>Press</p> 	<p>MILLI-Q PRODUCT</p> <ul style="list-style-type: none"> $M\Omega.cm$ ✓ $\mu S/cm$
<p>Press</p> 	<p>UNITS</p> <ul style="list-style-type: none"> Milli-Q Product → Tank Volume → 	<p>If you want to change the Units of Tank Volume, then perform a similar action to that above.</p>	<p>TANK VOLUME</p> <ul style="list-style-type: none"> % ✓ L Gallon
<p>Press 2 times on</p> 	<p>MANAGER MENU</p> <ul style="list-style-type: none"> Change ID and Pass → Date and Time → Set Points → Units → Setup → User Parameters → History → 		

3-18.2 TEMPERATURE COMPENSATION

It is possible to show non-temperature compensated resistivity or non-temperature compensated conductivity. Temperature compensation is a way of standardising resistivity or conductivity to measurements that would be seen if the water temperature was 25°C.

<p>MANAGER MENU</p> <ul style="list-style-type: none"> Change ID and Pass → Date and Time → Set Points → Units → Setup → User Parameters → History → 	<p>Select Setup. Press</p>	<p>SETUP</p> <ul style="list-style-type: none"> Buzzer → MQ Recirc Mode → POD Flow Stop → Temp Comp Mode → Flow Calibration → UV 185 nm Activation → Network Settings → 	<p>Select Temp Comp Mode. Press</p>
<p>TEMP COMP MODE</p> <ul style="list-style-type: none"> TC1 ✓ TC2 NTC 	<p>Select the Temp Comp Mode you want (see below).</p>	<p>TEMP COMP MODE</p> <ul style="list-style-type: none"> TC1 ✓ TC2 NTC 	<p>Press</p>
<p>SETUP</p> <ul style="list-style-type: none"> Buzzer → MQ Recirc Mode → POD Flow Stop → Temp Comp Mode → Flow Calibration → UV 185 nm Activation → Network Settings → 	<p>Press</p>	<p>MANAGER MENU</p> <ul style="list-style-type: none"> Change ID and Pass → Date and Time → Set Points → Units → Setup → User Parameters → History → 	





NTC (Non Temperature Compensation) means that the temperature compensation is off. The displayed resistivity or conductivity is not temperature compensated. The temperature of the water is shown at the same time as the non-temperature compensated resistivity or conductivity value.

TC1 is the normal setting. This setting displays resistivity or conductivity values that are temperature compensated to 25°C. The values are normalised. The Milli-Q System Firmware eliminates small fluctuations of temperature compensated resistivity or conductivity due to the fact that these two parameters are not measured at the same time.

TC2 is a setting that gives actual temperature compensated resistivity or conductivity values. In some operating conditions the feed water can be warmer or cooler than the water temperature inside the Milli-Q System. This can cause small fluctuations of the resistivity and conductivity values. Resistivity values could fluctuate between 18.0 MΩ.cm and 18.4 MΩ.cm @ 25°C while the actual resistivity value is 18.2 MΩ.cm @ 25°C. The TC2 setting should be used in applications that require the detection of trace ionic levels or when performing the verification of the Milli-Q System resistivity meter operation with an independent calibrated resistivity meter.









3-18.3 MQ RECIRC MODE

The **MQ Recirc Mode** parameter is a setting for how many minutes, per hour of **READY** Mode, the Milli-Q System recirculates water internally. This is done to insure optimal water quality.

<p>MANAGER MENU</p> <ul style="list-style-type: none"> Change ID and Pass → Date and Time → Set Points → Units → Setup → User Parameters → History → 	<p>Select Setup. Press</p>		<p>SETUP</p> <ul style="list-style-type: none"> Buzzer → MQ Recirc Mode → POD Flow Stop → Temp Comp Mode → Flow Calibration → UV 185 nm Activation → Network Settings → 	<p>Select MQ Recirc Mode. Press</p>	
<p>MQ RECIRC MODE</p> <p>Automatic Recirculation = 5 min/h</p> <p>Press ↑ and ↓ to adjust. Press ✓ to validate. Press ← to exit.</p>	<p>Change the Automatic Recirculation Time (for example, change it to 10 minutes).</p>	<p>MQ RECIRC MODE</p> <p>Automatic Recirculation = 10 min/h</p> <p>Press ↑ and ↓ to adjust. Press ✓ to validate. Press ← to exit.</p>	<p>Press</p>		
<p>SETUP</p> <ul style="list-style-type: none"> Buzzer → MQ Recirc Mode → POD Flow Stop → Temp Comp Mode → Flow Calibration → UV 185 nm Activation → Network Settings → 	<p>Press</p>		<p>MANAGER MENU</p> <ul style="list-style-type: none"> Change ID and Pass → Date and Time → Set Points → Units → Setup → User Parameters → History → 		

3-18.4 POD FLOW STOP

If you press the Q-POD Dispenser Plunger all the way down and release, then the Q-POD Dispenser is locked while dispensing at high flow. It continues to dispense until it automatically stops. The time it takes to automatically stop is called the **POD Flow Stop** time. This feature is primarily used to prevent undesired dispensing. Note that this is different than using the Volumetric Dispensing function.

<p>MANAGER MENU</p> <p>Change ID and Pass →</p> <p>Date and Time →</p> <p>Set Points →</p> <p>Units →</p> <p>Setup →</p> <p>User Parameters →</p> <p>History →</p>	<p>Select Setup. Press</p> 	<p>SETUP</p> <p>Buzzer →</p> <p>MQ Recirc Mode →</p> <p>POD Flow Stop →</p> <p>Temp Comp Mode →</p> <p>Flow Calibration →</p> <p>UV 185 nm Activation →</p> <p>Network Settings →</p>	<p>Select POD Flow Stop. Press</p> 
<p>POD FLOW STOP</p> <p>This parameter is used to stop the Flow of water from the Q-POD after a specific time at Full Flow. This prevents undesired dispensing. →</p>	<p>Press</p> 	<p>POD FLOW STOP</p> <p>Timer Activation →</p> <p>Adjust Timer →</p>	<p>Select Timer Activation. Press</p> 
<p>TIMER ACTIVATION</p> <p>Yes ✓</p> <p>No</p>	<p>Select No if you do not want the Milli-Q System to set the time to automatically stop dispensing water.</p> <p>Select Yes if you want to set the time to automatically stop dispensing water.</p>	<p>If you Select Yes, then press</p> 	<p>ADJUST TIMER</p> <p>Maximum Flow Time = 40 minutes.</p> <p>Press ↑ and ↓ to adjust. Press ✓ to validate. Press ← to exit.</p>
<p>After adjusting the time, press</p> 	<p>POD FLOW STOP</p> <p>Timer Activation →</p> <p>Adjust Timer →</p>	<p>Press 3 times on</p> 	<p>MANAGER MENU</p> <p>Change ID and Pass →</p> <p>Date and Time →</p> <p>Set Points →</p> <p>Units →</p> <p>Setup →</p> <p>User Parameters →</p> <p>History →</p>
<p>NOTE:</p> <p>If the timer is already set to Yes, then input the timer as shown here.</p>	<p>POD FLOW STOP</p> <p>Timer Activation →</p> <p>Adjust Timer →</p>	<p>ADJUST TIMER</p> <p>Maximum Flow Time = 30 minutes.</p> <p>Press ↑ and ↓ to adjust. Press ✓ to validate. Press ← to exit.</p>	<p>After adjusting the time, press</p> 

3-18.5 BUZZER

The Buzzer sounds when there is an Alarm or Alert message. It is possible to change which type of message turns the Buzzer on. For example, it is possible to turn on the Buzzer only with an Alarm message. It is also possible to never turn on the Buzzer with any message.

<p>MANAGER MENU</p> <ul style="list-style-type: none"> Change ID and Pass → Date and Time → Set Points → Units → Setup → User Parameters → History → 	<p>Select Setup. Press</p> 	<p>SETUP</p> <ul style="list-style-type: none"> Buzzer → MQ Recirc Mode → POD Flow Stop → Temp Comp Mode → Flow Calibration → UV 185 nm Activation → Network Settings → 	<p>Select Buzzer. Press</p> 
<p>BUZZER ACTIVATION</p> <ul style="list-style-type: none"> No <input checked="" type="checkbox"/> Alarm Alarm & Alert 	<p>Select the type of message that should turn on the Buzzer. For example, Select Alarm if you want the Buzzer to turn on only with an Alarm message.</p>	<p>BUZZER ACTIVATION</p> <ul style="list-style-type: none"> No <input checked="" type="checkbox"/> Alarm Alarm & Alert 	<p>Press</p> 
<p>SETUP</p> <ul style="list-style-type: none"> Buzzer → MQ Recirc Mode → POD Flow Stop → Temp Comp Mode → Flow Calibration → UV 185 nm Activation → Network Settings → 	<p>Press</p> 	<p>MANAGER MENU</p> <ul style="list-style-type: none"> Change ID and Pass → Date and Time → Set Points → Units → Setup → User Parameters → History → 	

3-18.6 ID AND PASSWORD

The LOGIN and PASSWORD can be changed. **The default Login is USER. The default Password is PASS.** The LOGIN and PASSWORD have a maximum length of 4 alphanumeric characters.













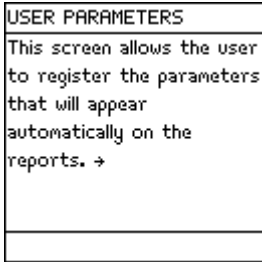

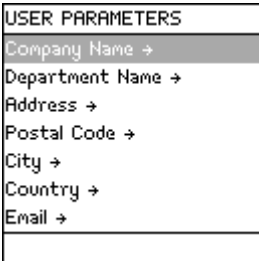
	<p>Select Change ID and Pass. Press</p>		<p>Suppose the Login is to be "john" and the Password is to be "1234".</p>
<p>Select the letter 'j' using the Keypad.</p>		<p>Press</p>	
<p>Repeat the previous steps until the Login is completed. Select the tick on the LCD using the Keypad.</p>		<p>Press</p>	
<p>Now input the new Password. Note that the Password is not actually shown on the LCD. It is shown as "*****".</p>		<p>Select the tick on the LCD using.</p>	
<p>Press</p>		<p>Press</p>	

3-18.7 USER PARAMETERS

The **User Parameters** LCD is used to change various data that appears on reports. An example of a report would be a History Printout from the Milli-Q.



A list of the **User Parameters** is shown here:

- Company Name
- Department Name
- Address
- Postal Code
- City
- Country
- Email
- Manager
- User 1
- User 2
- Telephone
- Application

	<p>Select User Parameters. Press</p> 		<p>Press</p> 
	<p>Select the parameter you want to input. For example, Company Name is chosen.</p> 		
<p>Select the first letter using the Keypad.</p> 		<p>Press</p> 	
<p>Now input the rest of the Company Name.</p>		<p>Select the tick on the LCD using the Keypad.</p> 	

Continued on the next page.





Continued from the previous page.





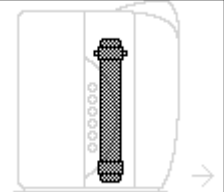
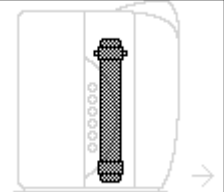
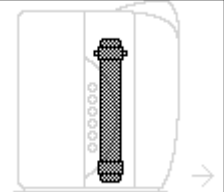

<p>Press</p> 	<table border="1"> <tr><th>USER PARAMETERS</th></tr> <tr><td>Company Name →</td></tr> <tr><td>Department Name →</td></tr> <tr><td>Address →</td></tr> <tr><td>Postal Code →</td></tr> <tr><td>City →</td></tr> <tr><td>Country →</td></tr> <tr><td>Email →</td></tr> <tr><td> </td></tr> </table>	USER PARAMETERS	Company Name →	Department Name →	Address →	Postal Code →	City →	Country →	Email →		<p>The Company Name is now entered. If desired, repeat the previous steps for other parameters.</p>	<p>When you are finished, press 2 times on</p> 
USER PARAMETERS												
Company Name →												
Department Name →												
Address →												
Postal Code →												
City →												
Country →												
Email →												
<table border="1"> <tr><th>MANAGER MENU</th></tr> <tr><td>Change ID and Pass →</td></tr> <tr><td>Date and Time →</td></tr> <tr><td>Set Points →</td></tr> <tr><td>Units →</td></tr> <tr><td>Setup →</td></tr> <tr><td>User Parameters →</td></tr> <tr><td>History →</td></tr> <tr><td> </td></tr> </table>				MANAGER MENU	Change ID and Pass →	Date and Time →	Set Points →	Units →	Setup →	User Parameters →	History →	
MANAGER MENU												
Change ID and Pass →												
Date and Time →												
Set Points →												
Units →												
Setup →												
User Parameters →												
History →												

Section 3-19 REGISTERING UV AND A10 LAMPS LIFETIME

The UV 185 nm Lamp and the A10 Lamp have to be registered during the installation of the Milli-Q System.

NOTE: Before doing this, make sure that the Date and Time have been set.



<table border="1"> <tr><th>STANDBY</th></tr> <tr><td>23 Jun 2006 13:31</td></tr> <tr><td>Menu →</td></tr> <tr><td>Ready →</td></tr> <tr><td> </td></tr> </table>	STANDBY	23 Jun 2006 13:31	Menu →	Ready →		<p>Press</p> 	<table border="1"> <tr><th>STANDBY MENU</th></tr> <tr><td>Maintenance →</td></tr> <tr><td>Sanitise/Clean →</td></tr> <tr><td>Suitability Tests →</td></tr> <tr><td>Language →</td></tr> <tr><td>Manager Menu →</td></tr> <tr><td> </td></tr> </table>	STANDBY MENU	Maintenance →	Sanitise/Clean →	Suitability Tests →	Language →	Manager Menu →		<p>Press</p> 
STANDBY															
23 Jun 2006 13:31															
Menu →															
Ready →															
STANDBY MENU															
Maintenance →															
Sanitise/Clean →															
Suitability Tests →															
Language →															
Manager Menu →															
<p>Choose Install UV 185 nm Lamp</p>	<table border="1"> <tr><th>MAINTENANCE</th></tr> <tr><td>Clean Strainer →</td></tr> <tr><td>Install Q-Gard →</td></tr> <tr><td>Install UV 185 Lamp →</td></tr> <tr><td>Install Quantum →</td></tr> <tr><td>Install A10 Lamp →</td></tr> <tr><td>Install POD Pak 1 →</td></tr> <tr><td>Install POD Pak 2 →</td></tr> <tr><td> </td></tr> </table>	MAINTENANCE	Clean Strainer →	Install Q-Gard →	Install UV 185 Lamp →	Install Quantum →	Install A10 Lamp →	Install POD Pak 1 →	Install POD Pak 2 →		<p>Press</p> 	<table border="1"> <tr><th>INSTALL UV 185 LAMP</th></tr> <tr><td></td></tr> <tr><td> </td></tr> </table>	INSTALL UV 185 LAMP		
MAINTENANCE															
Clean Strainer →															
Install Q-Gard →															
Install UV 185 Lamp →															
Install Quantum →															
Install A10 Lamp →															
Install POD Pak 1 →															
Install POD Pak 2 →															
INSTALL UV 185 LAMP															
															
<table border="1"> <tr><th>INSTALL UV 185 LAMP</th></tr> <tr><td>This procedure should be performed by a Millipore trained service engineer. Press → to continue or ← to exit.</td></tr> <tr><td> </td></tr> </table>	INSTALL UV 185 LAMP	This procedure should be performed by a Millipore trained service engineer. Press → to continue or ← to exit.		<table border="1"> <tr><th>INSTALL UV 185 LAMP</th></tr> <tr><td>The Millipore trained service engineer confirms UV 185 nm Lamp installation by pressing √. ←</td></tr> <tr><td> </td></tr> </table>	INSTALL UV 185 LAMP	The Millipore trained service engineer confirms UV 185 nm Lamp installation by pressing √. ←		<p>Press</p> 	<table border="1"> <tr><th>INSTALL UV 185 LAMP</th></tr> <tr><td>UV 185 nm Lamp installation is registered. Next maintenance in 730 days.←</td></tr> <tr><td> </td></tr> </table>	INSTALL UV 185 LAMP	UV 185 nm Lamp installation is registered. Next maintenance in 730 days.←				
INSTALL UV 185 LAMP															
This procedure should be performed by a Millipore trained service engineer. Press → to continue or ← to exit.															
INSTALL UV 185 LAMP															
The Millipore trained service engineer confirms UV 185 nm Lamp installation by pressing √. ←															
INSTALL UV 185 LAMP															
UV 185 nm Lamp installation is registered. Next maintenance in 730 days.←															

<p>STANDBY</p> <p>23 Jun 2006 13:31</p> <p>Menu →</p> <p>Ready →</p>	<p>Press</p>		<p>STANDBY MENU</p> <p>Maintenance →</p> <p>Sanitise/Clean →</p> <p>Suitability Tests →</p> <p>Language →</p> <p>Manager Menu →</p>	<p>Press</p>	
<p>Choose Install A10 Lamp</p>	<p>MAINTENANCE</p> <p>Clean Strainer →</p> <p>Install Q-Gard →</p> <p>Install UV 185 Lamp →</p> <p>Install Quantum →</p> <p>Install A10 Lamp →</p> <p>Install POD Pak 1 →</p> <p>Install POD Pak 2 →</p>	<p>Press</p>		<p>INSTALL A10 LAMP</p> 	
<p>INSTALL A10 LAMP</p> <p>This procedure should be performed by a Millipore trained service engineer. Press → to continue or ← to exit.</p>	<p>Press</p>		<p>INSTALL A10 LAMP</p> <p>The Millipore trained service engineer confirms A10 Lamp installation by pressing ✓. ←</p>	<p>Press</p>	
<p>INSTALL A10 LAMP</p> <p>A10 Lamp installation is registered. Next maintenance in 365 days. ←</p>					

CHAPTER 4 USING THE MILLI-Q SYSTEM

Section 4-1 MILLI-Q SYSTEM CABINET KEYPAD AND LCD

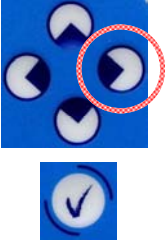
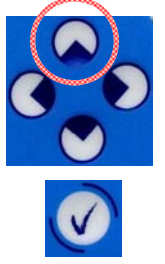
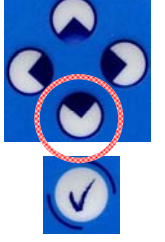
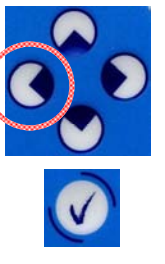
Some examples of using the Milli-Q System Cabinet Keypad and LCD are shown below.

<p>STANDBY</p> <p>03 Feb 2006 21:53</p> <p>Menu →</p> <p>Ready →</p>		<p>READY</p> <p>03 Feb 2006 21:56</p> <p>Menu →</p> <p>Standby →</p>
<p>MILLI-Q PRODUCT TOC</p> <p>Milli-Q Product TOC</p> <p>Setpoint = 50 ppb</p> <p>Press ↑ and ↓ to adjust.</p> <p>Press ✓ to validate. Press ← to exit.</p>		<p>MILLI-Q PRODUCT TOC</p> <p>Milli-Q Product TOC</p> <p>Setpoint = 51 ppb</p> <p>Press ↑ and ↓ to adjust.</p> <p>Press ✓ to validate. Press ← to exit.</p>
<p>STANDBY</p> <p>12 Feb 2006 17:45</p> <p>Menu →</p> <p>Ready →</p>		<p>STANDBY</p> <p>12 Feb 2006 17:45</p> <p>Menu →</p> <p>Ready →</p>
<p>MQ RECIRC MODE</p> <p>Automatic Recirculation = 10 min/h</p> <p>Press ↑ and ↓ to adjust.</p> <p>Press ✓ to validate. Press ← to exit.</p>		<p>SETUP</p> <p>Buzzer →</p> <p>MQ Recirc Mode →</p> <p>POD Flow Stop →</p> <p>Temp Comp Mode →</p> <p>Flow Calibration →</p> <p>UV 185 nm Activation →</p> <p>Network Settings →</p>
<p>MILLI-Q PRODUCT TOC</p> <p>Milli-Q Product TOC</p> <p>Setpoint = 51 ppb</p> <p>Press ↑ and ↓ to adjust.</p> <p>Press ✓ to validate. Press ← to exit.</p>		<p>SET POINTS</p> <p>Milli-Q Feed Cond →</p> <p>Milli-Q Inter Res →</p> <p>Milli-Q Product Res →</p> <p>Milli-Q Product TOC →</p> <p>Millipak →</p> <p>BioPak →</p> <p>Other POD Pak A →</p>

Section 4-2 SOFTWARE MAP

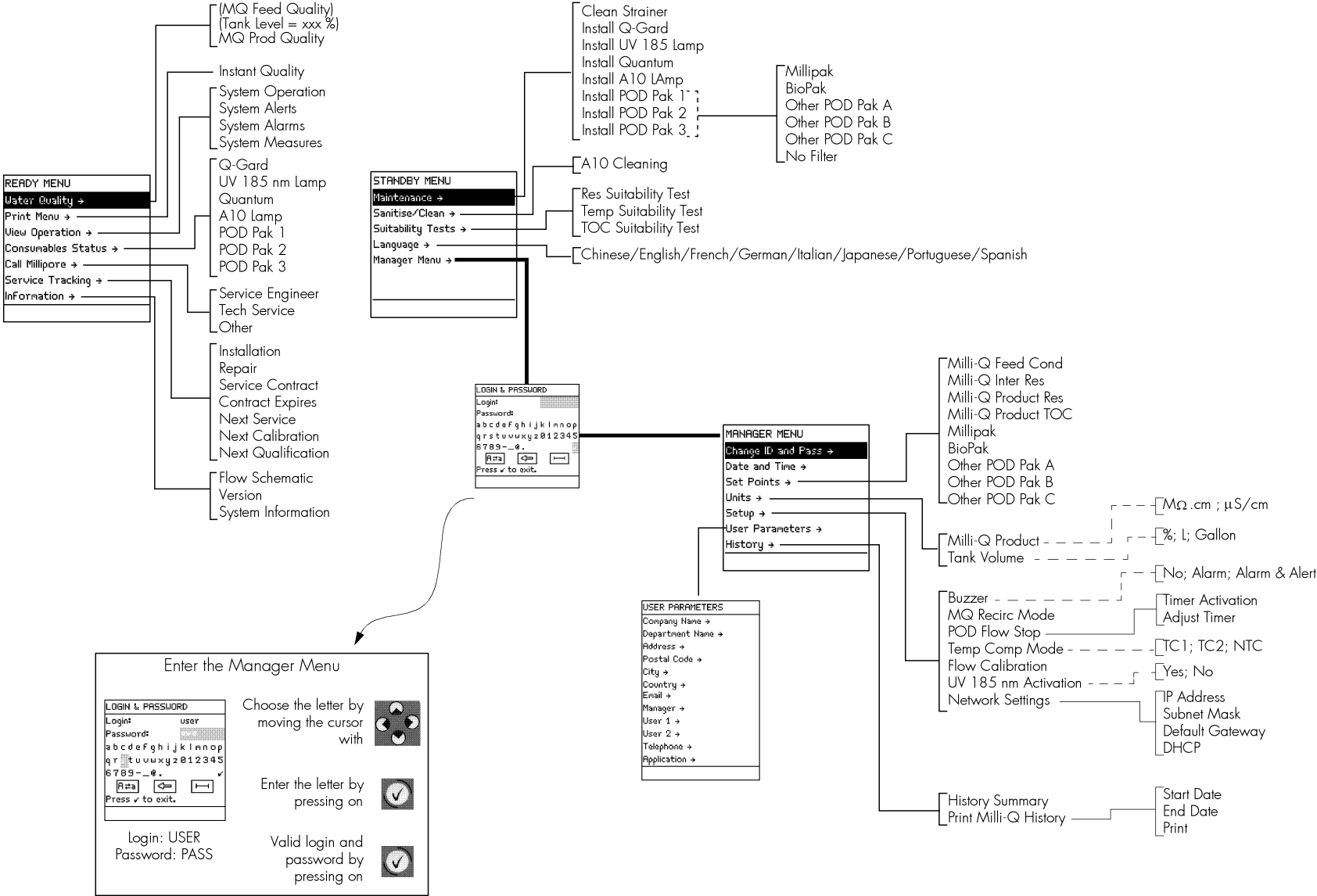

Section 4-3 STANDBY MODE AND READY MODE

4-3.1 WHAT IS STANDBY MODE?

STANDBY Mode is selected before attempting maintenance on the Milli-Q System.

It is not possible to dispense water in **STANDBY** Mode.

In **STANDBY** Mode, pressing the Q-POD Dispenser Plunger down allows the Milli-Q System to depressurise.

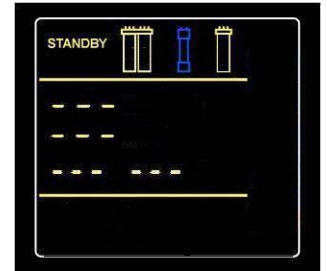
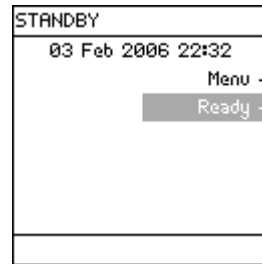

4-3.2 WHAT IS READY MODE?

In READY Mode, water can be dispensed from the Q-POD Dispenser. The Milli-Q System should be left in READY Mode most of the time.

The Milli-Q System should be left in **READY** Mode during the evenings, weekends and other times of non-use.

The Main Display and the Q-POD Dispenser Display in **READY** Mode are shown to the right.

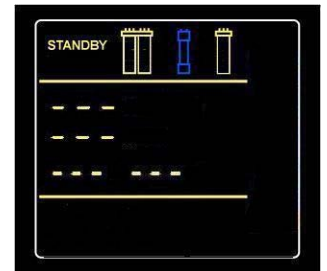
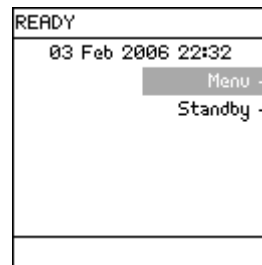

4-3.3 HOW TO GO FROM STANDBY MODE TO READY MODE

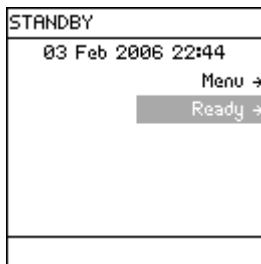

Select **Ready**. Press

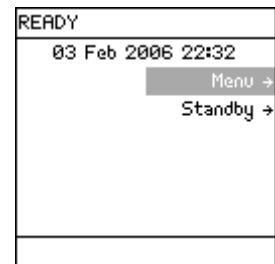

4-3.4 HOW TO GO FROM READY MODE TO STANDBY MODE

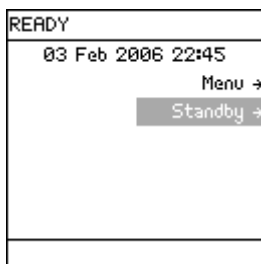

Select **Standby**. Press

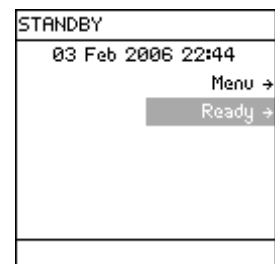

Section 4-4 HOW TO DISPENSE WATER

4-4.1 MANUAL DISPENSING

ADJUSTING THE HEIGHT OF THE Q-POD DISPENSER

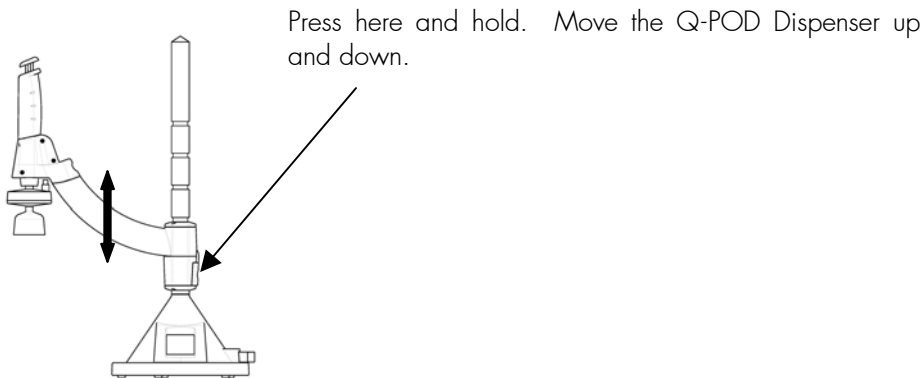

USING THE Q-POD DISPENSER

To dispense water, press down on the Q-POD Dispenser plunger while in **READY** Mode.

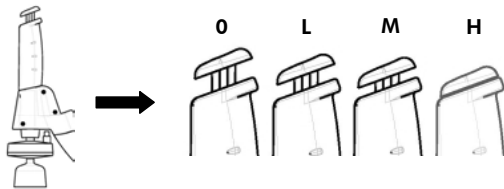

0	No water delivered
L	Low Flow (push slightly)
M	Medium Flow (push 1/2 way down)
H	High Flow (push down and hold or push down and release)

The Q-POD Dispenser has a microswitch inside. When you press the Q-POD Plunger all the way down and then release it, the Q-POD microswitch is in a locked position. When the microswitch is in locked position, water can be continuously dispensed from the Q-POD Dispenser in high flow. **You cannot dispense water from 2 Q-POD Dispensers at the same time or when an alarm has stopped the system. See Section 4-6 for further information.**



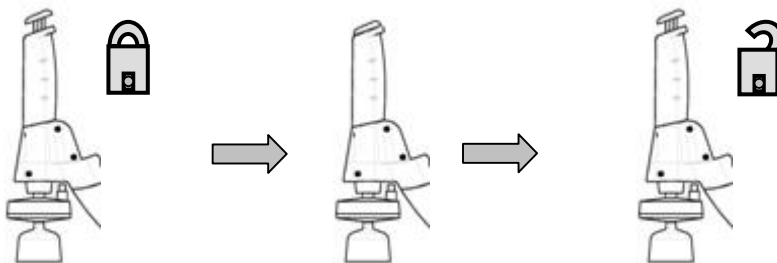



A Q-POD Dispenser has its microswitch unlocked by pressing the Plunger all the way down and releasing it. This is shown below.

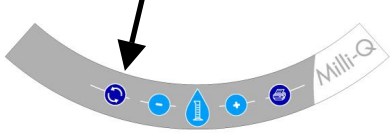

4-4.2 VOLUMETRIC DISPENSING

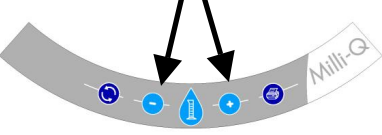
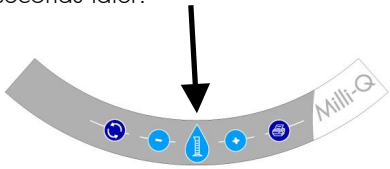
It is possible to have volumetric dispensing with the Q-POD Dispenser. This feature works from any Q-POD Dispenser (i.e. your Milli-Q System has two Q-POD Dispensers).

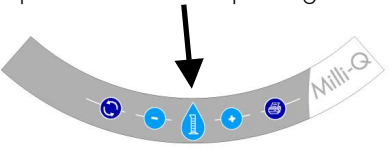
It is possible to volumetrically dispense water from the Q-POD Dispenser in amounts of 0.1 Litre, 0.25 L, 0.5 L, 0.75 L, 1 L, 1.25 L, 1.5 L, 1.75 L, 2 L, 3 L, ..., 60 Litre.

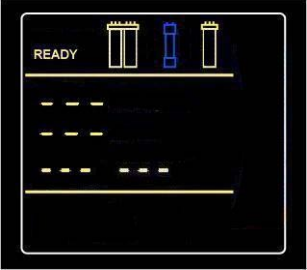
<p>Make sure the Milli-Q System is in READY Mode.</p> <p>Place the Milli-Q System into a forced recirculation mode.</p> <p>To do this, press this button on the Q-POD Keypad.</p> 	<p>The Q-POD Display will look like this. In this example, the desired amount of water is 4 Litres.</p> 	<p>Press these buttons on the Q-POD Keypad to change the desired amount of water.</p> 
<p>Press this button on the Q-POD Keypad. The Q-POD Dispenser will start dispensing water a few seconds later.</p> 	<p>While water is being dispensed, the Q-POD Display will look like this.</p> 	<p>To cancel volumetric dispensing, press this button at any time.</p> <p>Do not press the Q-POD Plunger to stop the volumetric dispensing.</p> 
<p>When volumetric dispensing is finished, the Q-POD Display will look like for 3 minutes.</p> 	<p>After 3 minutes, the Q-POD Display will look like this.</p> 	

4-4.3 FOOTSWITCH

It is possible to use a Footswitch accessory with the Q-POD Dispenser. The Footswitch cable is connected to the Q-POD Base.

The instructions for installing the Footswitch are not supplied in this User Manual. See the Insert supplied with the Footswitch or contact Millipore.

There are 2 ways to use the Footswitch. These are explained below.

- **Press and hold down the Footswitch**

The Milli-Q System dispenses water at high flow until you release the Footswitch.

- **Press and quickly release the Footswitch**





The Milli-Q System dispenses water continuously at high flow. Press the Footswitch again to stop dispensing water.

Section 4-5 VIEWING AND PRINTING WATER QUALITY

4-5.1 VIEWING WATER QUALITY ON THE Q-POD DISPENSER

See Section 4-6.1.

4-5.2 WATER QUALITY ON THE MAIN DISPLAY









<p>READY 03 Feb 2006 21:56 Menu → Standby →</p>	<p>Select Menu. Press</p>	<p>READY MENU Water Quality → Print Menu → View Operation → Consumables Status → Call Millipore → Service Tracking → Information →</p>	<p>Select Water Quality. Press</p>		
		<p>WATER QUALITY MQ Prod Quality →</p>	<p>Select MQ Prod Quality. Press</p>	<p>MQ PROD QUALITY MQ Res= 18.2 MΩ·cm TC MQ T= 24.9 °C MQ TOC = 4 ppb ←</p>	<p>The Milli-Q Water quality values are shown. Note that "TC" means that the resistivity value is temperature compensated.</p>
	<p>Press 3 times on</p>		<p>READY 06 Feb 2006 17:36 Menu → Standby →</p>		

4-5.3 PRINTING THE INSTANT MILLI-Q WATER QUALITY

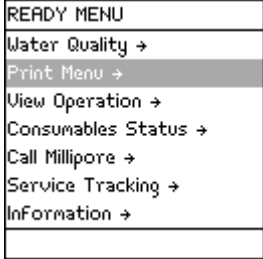
WHERE TO CONNECT THE PRINTER CABLE

The printer cable needs to terminate in a 25 pin male parallel printer port connection. It plugs into the base of the Q-POD Dispenser.

PRINTING FROM THE MAIN DISPLAY

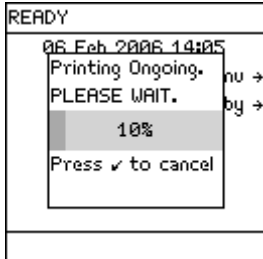
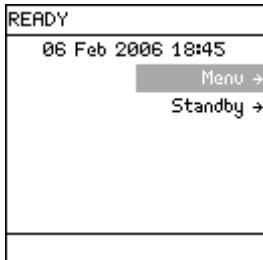
	<p>Select Menu. Press</p> 		<p>Select Print Menu. Press</p> 
	<p>The Milli-Q System should be dispensing water. Press</p> 		<p>Press</p> 
<p>It may take a few minutes for the printout to begin.</p>		<p>The printing has finished.</p>	
<p>Press 3 times on</p> 			

PRINTING FROM THE Q-POD DISPENSER

In **READY** Mode, press the Printer Keypad button on the Q-POD Dispenser. It may take a few minutes for the printout to begin.

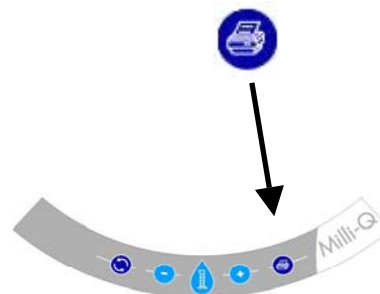

Section 4-6 UNDERSTANDING THE Q-POD DISPENSER DISPLAY AND KEYPAD

4-6.1 Q-POD DISPENSER DISPLAY

1 STANDBY Mode and Ready Mode

- **STANDBY** Mode is used only for Maintenance, Settings or entering the Manager Menu.
- **READY** Mode is used for delivering Milli-Q Water.

2 Reservoir Level

- If the Milli-Q System is fed by a reservoir, then its volume is represented by 10 graphic bars (each bar equals 10% of the total reservoir volume).

3 Displayed values

- **Resistivity** (MΩ.cm or μS/cm) – Milli-Q Water resistivity or conductivity
- **TOC** (ppb) – Milli-Q Water Total Oxidizable Carbon
- **Temperature** (°C) – Milli-Q Water temperature
- **Volume** (L) – Volumetric dispensing value

4 Consumable Status

▪ Q-Gard Pack



Blinking – Pack needs replacement



Pack out



Pack not used



Pack used

▪ Quantum Cartridge



Blinking – Cartridge needs replacement



Cartridge out



Pack not used



Pack used

▪ UV 185 nm Lamp



Blinking - check UV 185 nm Lamp, contact Millipore or Lamp needs replacement



OFF



ON

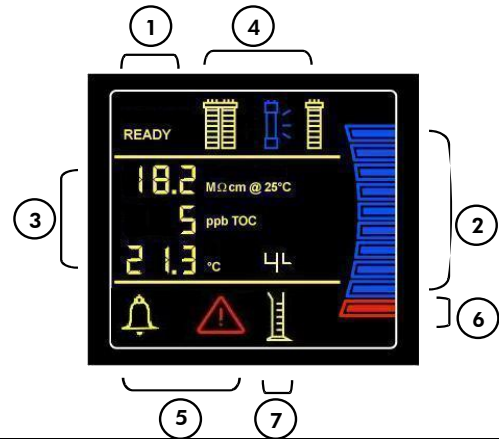

5 Alert and Alarm Symbols



Alert Symbol – maintenance is needed. See MAINTENANCE Chapter.



Alarm Symbol – immediate action required. Water quality out of specification or hardware problem.

6a Water not available



Blinking

- Water dispensing not available. Another Q-POD Dispenser is dispensing.

6b



Blinking



Steady

- Flow Autostop Alarm. Press and release the Q-POD Plunger.

6c



Blinking



Blinking

- Alarm Stop. Check if another Q-POD Dispenser is locked or see main display for further information.

7 Volumetric dispensing



Symbol present during volumetric dispensing.







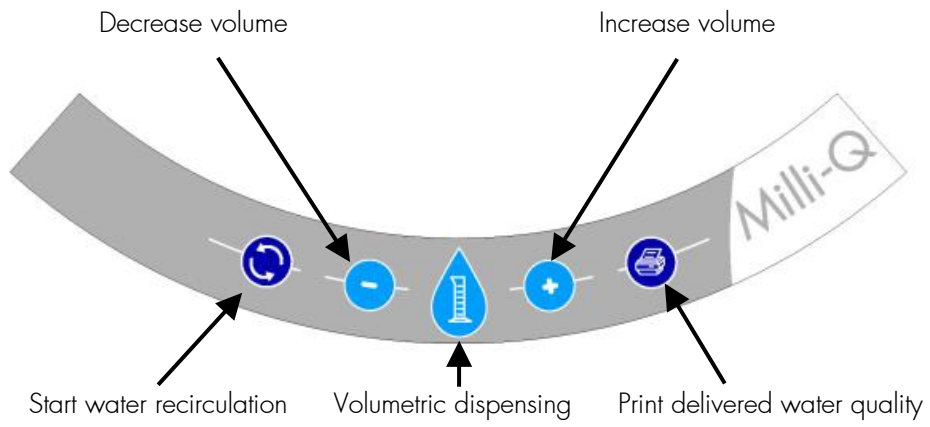

Symbol gone – Milli-Q System is not using volumetric dispensing.

4-6.2 Q-POD DISPENSER KEYPAD





Section 4-7 PRINTING THE SYSTEM HISTORY

<p>Go to the MANAGER MENU. See Section 3-12 for more information.</p>	<pre>MANAGER MENU Change ID and Pass → Date and Time → Set Points → Units → Setup → User Parameters → History →</pre>	<p>Select History. Press</p> 	<pre>HISTORY History Summary → Print Milli-Q History →</pre>
<p>Select Print Milli-Q History. Press</p> 	<pre>MILLI-Q WATER HISTORY Start Date → End Date → Print →</pre>	<p>Select Start Date. Press</p> 	<pre>START DATE 06 Feb 2006 19:09 Press ↑ and ↓ to adjust. Press → and ← to navigate. Press ✓ to confirm and exit.</pre>
<p>Input the date and time. Press</p> 	<pre>MILLI-Q WATER HISTORY Start Date → End Date → Print →</pre>	<p>Input the End Date (not shown here). <u>It is recommended to print a maximum of one month at a time.</u> In this example, the Start Date and End Date are 31 days apart.</p>	<p>Select Print. Press</p> 
<pre>MILLI-Q WATER HISTORY Press ✓ to print 31 days of Milli-Q Water History. We suggest that you print a maximum of one month of history at a time. ←</pre>	<p>Press</p> 	<p>When the printing is done, the LCD looks like this.</p>	<pre>MILLI-Q WATER HISTORY Press ✓ to print 31 days of Milli-Q Water History. We suggest that you print a maximum of one month of history at a time. ←</pre>
<p>Press 3 times on</p> 	<pre>MANAGER MENU Change ID and Pass → Date and Time → Set Points → Units → Setup → User Parameters → History →</pre>		



Section 4-8 VIEW OPERATION

VIEW OPERATION allows you to see the status of major components.

<p>READY MENU</p> <p>Water Quality →</p> <p>Print Menu →</p> <p>View Operation →</p> <p>Consumables Status →</p> <p>Call Millipore →</p> <p>Service Tracking →</p> <p>Information →</p>	<p>Select View Operation. Press</p> 	<p>VIEW OPERATION</p> <p>System Operation →</p> <p>System Alerts →</p> <p>System Alarms →</p> <p>System Measures →</p>	<p>Select the section you would like to see.</p> <p>All four sections are shown in this part of the User Manual.</p>
<p>SYSTEM OPERATIONS</p> <p>MQ Operation: Recirculation</p> <p>Dist Pump: On</p> <p>TOC Meter: On</p> <p>UV 185 NM Lamp: On</p> <p>←</p>	<p>In this example, the Milli-Q System is Dispensing Mode. The status of other components is shown.</p>		
<p>SYSTEM ALERTS</p> <p>Replace UV 185 nm</p>	<p>An example Alert is shown here. This is an Alert that is currently being displayed on the bottom of the Main Display in READY or STANDBY Mode.</p>	<p>When the timer for the UV 185 nm Lamp is reset, then this Alert is no longer shown on the SYSTEM ALERTS LCD.</p>	<p>SYSTEM ALERTS</p> <p>No Alerts</p>
<p>SYSTEM ALARMS</p> <p>Flow Auto Stop</p>	<p>An example Alarm is shown here. This is an Alarm that is currently displayed on the Main Display unless you override the display for one hour.</p>	<p>When the cause of this Alarm is fixed, then this Alarm is no longer listed on the SYSTEM ALARMS LCD.</p>	<p>SYSTEM ALARMS</p> <p>No Alarms</p>
<p>SYSTEM MEASURES</p> <p>Milli-Q Water Production Time:</p> <p>1.2 HOURS</p> <p>Dist Pump:</p> <p>22.5 V DC - 750 mA</p> <p>Dist Flow:</p> <p>2.0 L/mn</p>	<p>Various measurements related to the Milli-Q System are shown here.</p>	<p>To see the UV 185 nm Lamp measurement, press</p> 	<p>SYSTEM MEASURES</p> <p>1.2 HOURS</p> <p>Dist Pump:</p> <p>22.5 V DC - 750 mA</p> <p>Dist Flow:</p> <p>2.0 L/mn</p> <p>UV 185 nm Lamp:</p> <p>130 mA ←</p>
<p>Press 2 times on</p> 	<p>READY MENU</p> <p>Water Quality →</p> <p>Print Menu →</p> <p>View Operation →</p> <p>Consumables Status →</p> <p>Call Millipore →</p> <p>Service Tracking →</p> <p>Information →</p>		



Section 4-9 VIEWING CONSUMABLES STATUS

Consumables Status allows you to see information related to the various consumables.

<table border="1"> <tr><td>READY MENU</td></tr> <tr><td>Water Quality →</td></tr> <tr><td>Print Menu →</td></tr> <tr><td>View Operation →</td></tr> <tr><td>Consumables Status →</td></tr> <tr><td>Call Millipore →</td></tr> <tr><td>Service Tracking →</td></tr> <tr><td>Information →</td></tr> </table>	READY MENU	Water Quality →	Print Menu →	View Operation →	Consumables Status →	Call Millipore →	Service Tracking →	Information →	<p>Select Consumables Status. Press</p> 	<table border="1"> <tr><td>CONSUMABLES STATUS</td></tr> <tr><td>Q-Gard →</td></tr> <tr><td>UV 185 nm Lamp →</td></tr> <tr><td>Quantum →</td></tr> <tr><td>A10 Lamp →</td></tr> <tr><td>POD Pak 1 →</td></tr> <tr><td>POD Pak 2 →</td></tr> <tr><td>POD Pak 3 →</td></tr> </table>	CONSUMABLES STATUS	Q-Gard →	UV 185 nm Lamp →	Quantum →	A10 Lamp →	POD Pak 1 →	POD Pak 2 →	POD Pak 3 →	<p>Select the consumable that you would like to see information about.</p>
READY MENU																			
Water Quality →																			
Print Menu →																			
View Operation →																			
Consumables Status →																			
Call Millipore →																			
Service Tracking →																			
Information →																			
CONSUMABLES STATUS																			
Q-Gard →																			
UV 185 nm Lamp →																			
Quantum →																			
A10 Lamp →																			
POD Pak 1 →																			
POD Pak 2 →																			
POD Pak 3 →																			
<table border="1"> <tr><td>Q-GARD</td></tr> <tr><td>Name: Q-Gard T1</td></tr> <tr><td>Cat N°: QGARDT1X1</td></tr> <tr><td>Lot N°: F6DN27329</td></tr> <tr><td>Installed: 5 Feb 2006</td></tr> <tr><td>Replace In: 182 days</td></tr> <tr><td>Volume: 123L ←</td></tr> </table>	Q-GARD	Name: Q-Gard T1	Cat N°: QGARDT1X1	Lot N°: F6DN27329	Installed: 5 Feb 2006	Replace In: 182 days	Volume: 123L ←	<table border="1"> <tr><td>QUANTUM</td></tr> <tr><td>Name: Quantum</td></tr> <tr><td>Cat N°: QTUM0TEX1</td></tr> <tr><td>Lot N°: F6DN27325</td></tr> <tr><td>Installed: 5 Feb 2006</td></tr> <tr><td>Replace In: 182 days</td></tr> <tr><td>Volume: 123L ←</td></tr> </table>	QUANTUM	Name: Quantum	Cat N°: QTUM0TEX1	Lot N°: F6DN27325	Installed: 5 Feb 2006	Replace In: 182 days	Volume: 123L ←	<p>The Q-Gard Pack status and the Quantum Cartridge status are shown to the left.</p>			
Q-GARD																			
Name: Q-Gard T1																			
Cat N°: QGARDT1X1																			
Lot N°: F6DN27329																			
Installed: 5 Feb 2006																			
Replace In: 182 days																			
Volume: 123L ←																			
QUANTUM																			
Name: Quantum																			
Cat N°: QTUM0TEX1																			
Lot N°: F6DN27325																			
Installed: 5 Feb 2006																			
Replace In: 182 days																			
Volume: 123L ←																			
<table border="1"> <tr><td>UV 185 NM LAMP</td></tr> <tr><td>Name: UV 185 nm Lamp</td></tr> <tr><td>Installed: 5 Feb. 2006</td></tr> <tr><td>Replace In: 730 days ←</td></tr> </table>	UV 185 NM LAMP	Name: UV 185 nm Lamp	Installed: 5 Feb. 2006	Replace In: 730 days ←	<p>The UV 185 nm Lamp status is shown.</p>														
UV 185 NM LAMP																			
Name: UV 185 nm Lamp																			
Installed: 5 Feb. 2006																			
Replace In: 730 days ←																			
<table border="1"> <tr><td>A10 LAMP</td></tr> <tr><td>Name: A10 Lamp</td></tr> <tr><td>Installed: 5 Feb 2006</td></tr> <tr><td>Replace In: 365 days ←</td></tr> </table>	A10 LAMP	Name: A10 Lamp	Installed: 5 Feb 2006	Replace In: 365 days ←	<p>The A10 Lamp status is shown.</p>														
A10 LAMP																			
Name: A10 Lamp																			
Installed: 5 Feb 2006																			
Replace In: 365 days ←																			
<table border="1"> <tr><td>POD PAK 1</td></tr> <tr><td>Name: Millipak</td></tr> <tr><td>Cat N°: MPGP04001</td></tr> <tr><td>Lot N°: See label</td></tr> <tr><td>Installed: 5 Feb 2006</td></tr> <tr><td>Replace In: 182 days ←</td></tr> </table>	POD PAK 1	Name: Millipak	Cat N°: MPGP04001	Lot N°: See label	Installed: 5 Feb 2006	Replace In: 182 days ←	<p>The POD Pak status on Q-POD Dispenser 1 is shown.</p>												
POD PAK 1																			
Name: Millipak																			
Cat N°: MPGP04001																			
Lot N°: See label																			
Installed: 5 Feb 2006																			
Replace In: 182 days ←																			
<p>Press 2 times on</p> 	<table border="1"> <tr><td>READY MENU</td></tr> <tr><td>Water Quality →</td></tr> <tr><td>Print Menu →</td></tr> <tr><td>View Operation →</td></tr> <tr><td>Consumables Status →</td></tr> <tr><td>Call Millipore →</td></tr> <tr><td>Service Tracking →</td></tr> <tr><td>Information →</td></tr> </table>			READY MENU	Water Quality →	Print Menu →	View Operation →	Consumables Status →	Call Millipore →	Service Tracking →	Information →								
READY MENU																			
Water Quality →																			
Print Menu →																			
View Operation →																			
Consumables Status →																			
Call Millipore →																			
Service Tracking →																			
Information →																			



Section 4-10 CALL MILLIPORE

Call Millipore allows you to see contact information. A Millipore Service Representative can put this information into the Milli-Q System.

<p>READY MENU</p> <ul style="list-style-type: none"> Water Quality → Print Menu → View Operation → Consumables Status → Call Millipore → Service Tracking → Information → 	<p>Select Call Millipore. Press</p> 	<p>CALL MILLIPORE</p> <ul style="list-style-type: none"> Service Engineer → Tech Service → Other → 	<p>Select the type of contact you would like information about (i.e. Service Engineer). Press</p> 
<p>SERVICE ENGINEER</p> <p>Name: John Smith</p> <p>Tel: 921 0037</p> <p>Email: John_Smith@Millipore.com ←</p>	<p>Press 2 times on</p> 	<p>READY MENU</p> <ul style="list-style-type: none"> Water Quality → Print Menu → View Operation → Consumables Status → Call Millipore → Service Tracking → Information → 	

Section 4-11 VIEWING SERVICE TRACKING



Service Tracking allows you to see service information about the Milli-Q System. A Millipore Service Representative can put this information into the Milli-Q System.

<p>READY MENU</p> <ul style="list-style-type: none"> Water Quality → Print Menu → View Operation → Consumables Status → Call Millipore → Service Tracking → Information → 	<p>Select Service Tracking. Press</p> 	<p>SERVICE TRACKING</p> <ul style="list-style-type: none"> Installation → Repair → Service Contract → Contract Expires → Next Service → Next Calibration → Next Qualification → 	<p>Select the type of Service you would like information about. Press</p> 
<p>INSTALLATION DATE</p> <p>Installation performed by John Smith Date 5 Feb 06. ←</p>	<p>Press 2 times on</p> 	<p>READY MENU</p> <ul style="list-style-type: none"> Water Quality → Print Menu → View Operation → Consumables Status → Call Millipore → Service Tracking → Information → 	

Section 4-12 VIEWING INFORMATION

Information allows you to see:

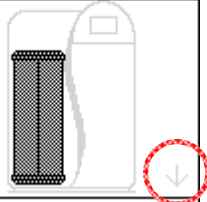
- Flow Schematic information
- Version information
- Serial Number and other information

<p>READY MENU</p> <p>Water Quality → Print Menu → View Operation → Consumables Status → Call Millipore → Service Tracking → Information →</p>	<p>Select Information. Press</p> 	<p>INFORMATION</p> <p>Flow Schematic → Version → System Information →</p>	<p>Select the section you would like to see information about.</p>
<p>FLOW SCHEMATIC</p> <p>This system produces and delivers ultra pure (type 1) Milli-Q water available at the Q-PODs. To understand the sequence of purification and control techniques used in this</p>	<p>FLOW SCHEMATIC - 1</p> 	<p>FLOW SCHEMATIC - 1</p> <p>Step 1 - Pre-treated water within specifications enters the Milli-Q through a Solenoid Valve and goes through a Q-Gard purification pack adapted to the Feed water quality.</p>	<p>The Flow Schematic information is a display of the major components of the Milli-Q System.</p>
<p>VERSION</p> <p>Boot Loader: V 1.02 System: v7 EPLD: v1.0 Measure: v1.0 Power Supply: v1.0 Q-POD 1: v1.0 Q-POD 2: v1.0</p>	<p>The various versions for the Milli-Q System are shown here.</p>	<p>The System (second line on the LCD) is something you should reference when you contact Millipore.</p>	
<p>SYSTEM INFORMATION</p> <p>Milli-Q Advantage A10 Cat N°: Z00Q0U0T0 Serial N°: F6DN27327B MFG Date: 1 Oct 2005 Inst Date: 5 Feb 2006←</p>	<p>The Catalogue Number, Serial Number and other information are shown here.</p>	<p>The Serial Number is something you should reference when you contact Millipore.</p>	
<p>Press 2 times on</p>  <p>unless you are viewing the Flow Schematic section.</p>	<p>READY MENU</p> <p>Water Quality → Print Menu → View Operation → Consumables Status → Call Millipore → Service Tracking → Information →</p>		

CHAPTER 5 MAINTENANCE**Section 5-1 MAINTENANCE SCHEDULE**

See Chapter 7 for Consumables ordering information.			
Item	Maintenance needed	When	How to
Q-Gard Pack	Replacement	When prompted to by an LCD message.	See Section 5-2.
Quantum Cartridge	Replacement	When prompted to by an LCD message.	See Section 5-3.
POD Pak	Replacement	When prompted to by an LCD message or as necessary.	See Section 5-4.
UV 185 nm Lamp	Replacement	When prompted to by an LCD message.	See Section 5-5.
A10 TOC Monitor	A10 Lamp Replacement	When prompted to by an LCD message.	See Section 5-6.
A10 TOC Monitor	Cleaning	When a new Q-Gard Pack or a new Quantum Cartridge is installed. When TOC values fluctuate.	See Section 5-7.
Inlet Strainer	Cleaning	When prompted to by an LCD message or as necessary.	See Section 5-8.

Section 5-2 HOW TO REPLACE THE Q-GARD PACK

5-2.1 WHEN TO REPLACE THE Q-GARD PACK?

The Q-Gard Pack should be replaced when one of the following Alert or Alarm messages is displayed. See Sections 6-2 and 6-3 for more information about how Alert and Alarm messages are displayed.

- **Alert message = REPLACE Q-GARD PACK**
- **Alarm message = MILLI-Q RES < SP, REPLACE Q-GARD AND QUANTUM**

5-2.2 DEPRESSURISE THE MILLI-Q SYSTEM



While in STANDBY Mode, push the Q-POD Dispenser Plunger down once to depressurise the Milli-Q System. After water stops being dispensed, push down the Q-POD Dispenser Plunger again. Do not attempt to remove the Q-Gard Pack or the Quantum Cartridge without depressurising the Milli-Q System first.

5-2.3 MAIN DISPLAY

The Milli-Q System Main Display will prompt you to read the information below. To see this, look at the displays below.

	<p>Select Menu.</p> <p>Press</p>		<p>Select Maintenance.</p> <p>Press</p>
	<p>Select Install Q-Gard.</p> <p>Press</p>		<p>The location of the Q-Gard Pack is shown.</p> <p>Press</p>
	<p>Press 4 times on</p>		

5-2.4 REMOVING THE USED Q-GARD PACK

Refer to the pictures after the next page when reading the instructions below.

1. **Make sure the Milli-Q System is in STANDBY Mode.** See Section 4-3.4 for information about going from **READY** Mode to **STANDBY** Mode.
2. **Make sure the Milli-Q System is depressurised** (see information above). Open the Milli-Q System left door.
3. Lift up the Pack Locking Handle.
4. Remove the used Q-Gard Pack.
5. The LCD should indicate that the Q-Gard Pack has been removed.



5-2.5 INSTALLING THE NEW Q-GARD PACK

1. Remove the new Q-Gard Pack from its shipping box.
2. Remove the plastic covers on the 2 ports of the Q-Gard Pack. Look inside the ports to locate the black rubber O-rings. Make sure these are firmly in-place.
3. Wet the O-rings with water.

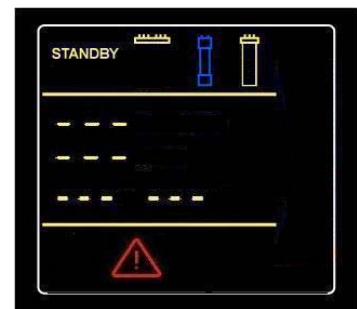
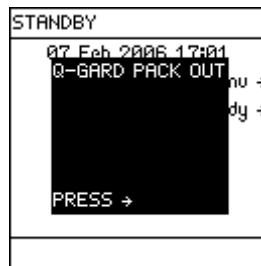

4. See the photographs on the next page as an illustrative guide. Push the top of the Q-Gard Pack into the ports on the Milli-Q System. Push on the bottom of the Q-Gard Pack.
5. Push the Pack Locking Handle down. If it doesn't go down easily, then make sure the top and the bottom of the Q-Gard Pack are pushed in.
6. Close the left door of the Milli-Q System Cabinet.

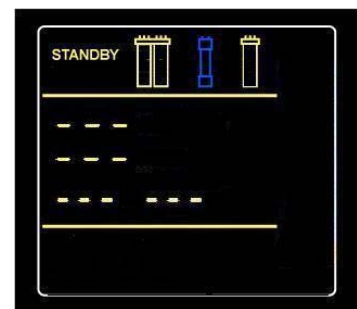

7. Press

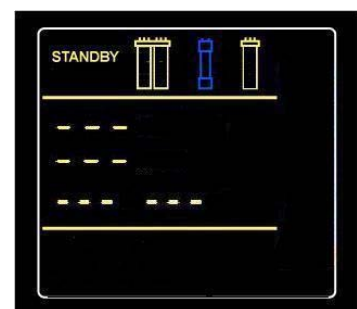
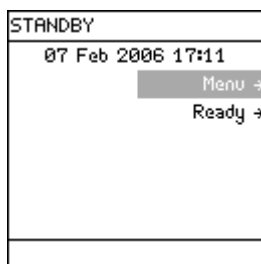

5-2.6 RINSING THE NEW Q-GARD PACK

The Q-Gard Pack needs to be rinsed out after it is installed. See Section 5-3.4 for more information.

5-2.7 A10 TOC MONITOR CLEANING AFTER Q-GARD PACK INSTALLATION

The A10 TOC Monitor should be cleaned when a new Q-Gard Pack is installed. Go to Section 5-7 and follow the instructions about cleaning the A10 TOC Monitor. If a new Quantum Cartridge is also being installed, then perform the A10 Cleaning after both the Q-Gard Pack and the Quantum Cartridge are installed.

Since the Quantum Cartridge is replaced whenever a Q-Gard Pack is replaced, see Section 5-3.

Pak Locking Handle being lifted up.

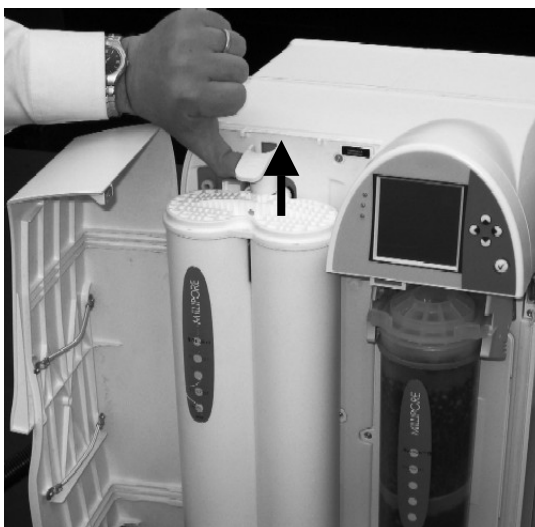

Q-Gard Pack being pulled out.



Pak Locking Handle lifted up.



Q-Gard Pack being pushed in at the top.



Q-Gard Pack pushed in at the bottom.



Pak Locking Handle being pushed down while holding the bottom of the Q-Gard Pack.



Section 5-3 HOW TO REPLACE THE QUANTUM CARTRIDGE

5-3.1 WHEN TO REPLACE THE QUANTUM CARTRIDGE?

The Quantum Cartridge should be replaced when one of the following Alert or Alarm messages is displayed. See Sections 6-2 and 6-3 for more information about how Alert and Alarm messages are displayed.

- **Alarm message = MILLI-Q RES < SP, REPLACE Q-GARD AND QUANTUM**
- **Alert message = REPLACE QUANTUM CARTRIDGE**

5-3.2 DEPRESSURISE THE MILLI-Q SYSTEM



ATTENTION

While in STANDBY Mode, push the Q-POD Dispenser Plunger down once to depressurise the Milli-Q System. After water stops being dispensed, push down the Q-POD Dispenser Plunger again. Do not attempt to remove the Q-Gard Pack or the Quantum Cartridge without depressurising the Milli-Q System first.

5-3.3 MAIN DISPLAY

The Milli-Q System Main Display will prompt you to read the information below. To see this, look at the displays immediately below.

	<p>Select Menu.</p> <p>Press</p>		<p>Select Maintenance.</p> <p>Press</p>
	<p>Select Install Quantum.</p> <p>Press</p>		<p>The location of the Quantum Cartridge is shown.</p> <p>Press</p>
	<p>Press 4 times on</p>		

5-3.4 REMOVING THE USED QUANTUM CARTRIDGE

Refer to the pictures on the next page when reading the instructions below.

1. **Make sure the Milli-Q System is in STANDBY Mode.** See Section 4-3.4 for information about going from **READY** Mode to **STANDBY** Mode.
2. **Make sure the Milli-Q System is depressurised** (see information above). Open the Milli-Q System right door.
3. Remove the used Quantum Cartridge.
4. The LCD should indicate that the Quantum Cartridge has been removed.

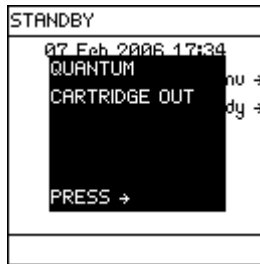

5-3.5 INSTALLING THE NEW QUANTUM CARTRIDGE

1. Remove the Quantum Cartridge from its shipping box.
2. Remove the plastic covers on the 2 ports of the Quantum Cartridge. There should be O-rings on the front view middle and left ports. The right port is not used and does not contain an O-ring.
3. Wet the 2 O-rings with water.

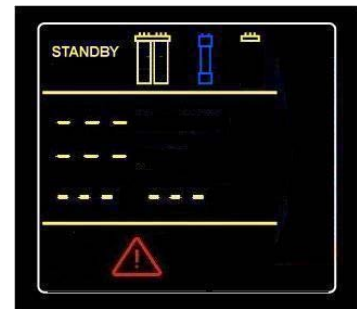
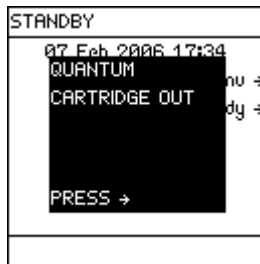

4. Install the Quantum Cartridge until it is fully seated into the ports as shown on the next page.
5. Close the right door of the Milli-Q System Cabinet.

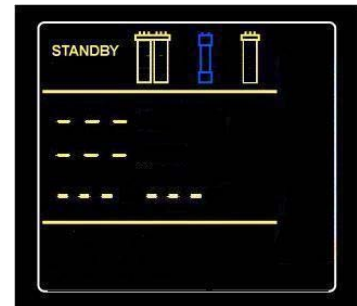
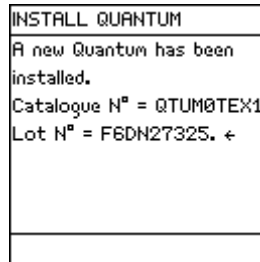

6. Press

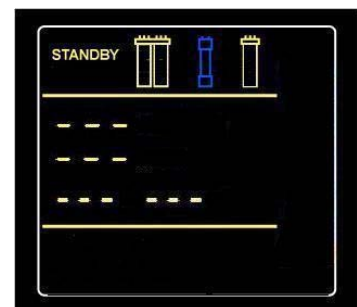
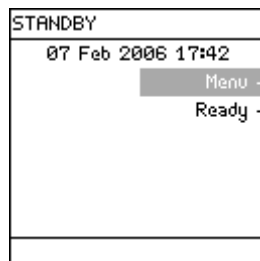

Quantum Cartridge being pulled out. Note use of fingers.



Quantum Cartridge being pulled out from the pack adapter.



Quantum Cartridge being placed into the pack adapter.



Top of Quantum Cartridge being pushed into place



Quantum Cartridge installed.



5-3.6 RINSING THE NEW QUANTUM CARTRIDGE (AND Q-GARD PACK)

A new Quantum Cartridge and a new Q-Gard Pack need to be rinsed out when they are installed.

1. Locate the clear tubing and the barbed fitting from the Accessories Bag.
2. Remove any POD Pak on the Q-POD Dispenser. Screw the barbed fitting onto the bottom end of the Q-POD Dispenser.



Do not use any white tape on the threads of the Barbed Fitting. An O-ring is located inside the Q-POD Dispenser.

3. Push one end of the clear tubing onto the end of the barbed fitting. Place the other end of the clear tubing in a sink.
4. Place the Milli-Q System into **READY** Mode.
5. Dispense water for about 10 minutes to the sink. This flushes out any trapped air in the Milli-Q System. This also rinses off the purification media located in the Q-Gard Pack and in the Quantum Cartridge.
6. Perform an A10 Cleaning at this time (see Section 5-3.7).
7. Leave the Milli-Q System in **READY** Mode overnight or for several hours (> 6 hours). Do not leave the Milli-Q System in **STANDBY** Mode.
8. Dispense water for about 10 minutes after the Milli-Q System has been left overnight or at least for several hours (> 6 hours).
9. Leave the Milli-Q System in **READY** Mode when finished.

5-3.7 A10 TOC MONITOR CLEANING AFTER QUANTUM CARTRIDGE INSTALLATION

The A10 TOC Monitor should be cleaned when a new Quantum Cartridge is installed. Go to Section 5-7 and follow the instructions about cleaning the A10 TOC Monitor. If a new Q-Gard Pack is also being installed, then perform the A10 Cleaning after both the Q-Gard Pack and the Quantum Cartridge are installed.

Q-POD Dispenser with barbed fitting and clear tubing. Water is about to be dispensed.



Section 5-4 HOW TO REPLACE A POD PAK

5-4.1 WHEN TO REPLACE A POD PAK?

REPLACEMENT BASED ON FLOWRATE

One possible reason for a decrease in Milli-Q Water flowrate is a clogged POD Pak. The POD Pak should be replaced when it appears to be clogged. Make sure the POD Pak is not air-locked. Dispense water and open the vent to see if there is any trapped air. Close the vent after this.

REPLACEMENT BASED UPON LCD MESSAGE

The POD Pak should be replaced when the following Alert message is displayed. See Section 6-2 for more information about how Alert messages are displayed.

- **Alert message = REPLACE POD PAK N° 1.**

Note that the POD Pak Number can also be 2 or 3 (i.e. REPLACE POD PAK N° 2 or REPLACE POD PAK N° 3).

5-4.2 REPLACING AND RINSING THE NEW MILLIPAK EXPRESS 40 FILTER

1. Stop dispensing water. Remove the used Millipak Express 40 Filter.
2. There should be an O-ring inside the Q-POD Dispenser. Make sure the O-ring remains in-place and does not come out.
3. Remove the new Millipak Express 40 Filter from its packaging.



Do not use any white tape on the threads of the Millipak Express 40 Filter. An O-ring is located inside the Q-POD Dispenser.

4. Screw the Millipak Express 40 Filter onto the Q-POD Dispenser. **Do not overtighten it.**
5. Register the POD Pak installation. See Section 5-4.4 for information.
6. Dispense water. Slightly open the vent on the top of the Millipak Express 40 Filter to remove air. Close the vent afterwards.
7. **Dispense water for approximately 5 minutes to flush out the Millipak Express 40 Filter.**

5-4.3 REPLACING AND RINSING THE NEW BIOPAK ULTRAFILTER









1. Stop dispensing water. Remove the used BioPak Ultrafilter.
2. There should be an O-ring inside the Q-POD Dispenser. Make sure the O-ring remains in-place and does not come out.



Do not use any white tape on the threads of the BioPak Ultrafilter. An O-ring is located inside the Q-POD Dispenser.

3. Take the BioPak Ultrafilter auto adhesive label and fill it with a permanent pen. Indicate the date of installation and the future replacement date (90 days later). Peel off the label and attach it on the BioPak Ultrafilter.
4. Screw the BioPak Ultrafilter onto the Q-POD Dispenser.
5. Register the POD Pak installation. See Section 5-4.4 for information.
6. Dispense water. Slightly open the vent on the top side of the BioPak Ultrafilter to remove air. Close the vent afterwards.
7. **Dispense water for approximately 10 minutes to flush out the BioPak Ultrafilter.**

5-4.4 HOW TO REGISTER A POD PAK BEING INSTALLED

<p>STANDBY</p> <p>02 Feb 2006 20:38</p> <p>Menu →</p> <p>Ready →</p>	<p>Select Menu. Press</p> 	<p>STANDBY MENU</p> <p>Maintenance →</p> <p>Sanitise/Clean →</p> <p>Suitability Tests →</p> <p>Language →</p> <p>Manager Menu →</p>	<p>Select Maintenance. Press</p> 
<p>MAINTENANCE</p> <p>Clean Strainer →</p> <p>Install Q-Gard →</p> <p>Install UV 185 Lamp →</p> <p>Install Quantum →</p> <p>Install A10 Lamp →</p> <p>Install POD Pak 1 →</p> <p>Install POD Pak 2 →</p>	<p>Select Install POD Pak 1 (if installing on Q-POD Dispenser 1). Press</p> 	<p>INSTALL POD PAK 1</p> 	<p>Press</p> 
<p>INSTALL POD PAK 1</p> <p>Select the POD Pak that you wish to install at Q-POD N°1. →</p>	<p>Press</p> 	<p>INSTALL POD PAK 1</p> <p>Millipak →</p> <p>BioPak →</p> <p>Other POD Pak A →</p> <p>Other POD Pak B →</p> <p>Other POD Pak C →</p> <p>No Filter →</p>	<p>Select the type of POD Pak you are installing.</p>
<p>Press</p> 	<p>INSTALL POD PAK 1</p> <p>Follow the instructions delivered with the new POD Pak and press √. ←</p>	<p>Press</p> 	<p>INSTALL POD Pak 1</p> <p>POD Pak installation is registered. Next maintenance in 182 days. ←</p>

You have finished registering a POD Pak installation.

Section 5-5 HOW TO REPLACE THE UV 185 NM LAMP

5-5.1 REPLACING THE UV 185 NM LAMP

It is recommended to have a Millipore Field Service Representative change the UV 185 nm Lamp. The replacement of the UV 185 nm Lamp involves removing the cover of the system. The instructions for replacing the UV 185 nm Lamp are not included in this User Manual. The instructions are included with the replacement UV 185 nm Lamp.

5-5.2 WHEN TO REPLACE THE UV 185 NM LAMP?

The UV 185 nm Lamp should be replaced when the following Alert message is displayed. See Section 6-2 for more information about how Alert messages are displayed.

- **Alert message = REPLACE UV 185 NM LAMP.**

Section 5-6 HOW TO REPLACE THE A10 LAMP

5-6.1 REPLACING THE A10 LAMP

It is recommended to have a Millipore Field Service Representative change the A10 Lamp. The replacement of the A10 Lamp involves removing the cover of the system. The instructions for replacing the A10 Lamp are not included in this User Manual. The instructions are included with the replacement A10 Lamp.

5-6.2 WHEN TO REPLACE THE A10 LAMP?

The A10 Lamp should be replaced when the following Alert message is displayed. See Section 6-2 for more information about how Alert messages are displayed.

- **Alert message = REPLACE A10 LAMP.**

Section 5-7 CLEANING THE A10 TOC MONITOR

The A10 TOC Monitor may need to be cleaned sometimes. This cleaning is initiated with the Milli-Q System Keypad and is simple to perform.

The Milli-Q System does not display any type of message indicating that a cleaning is needed.

The A10 TOC Monitor cleaning takes 60 minutes to complete.





PURPOSE OF CLEANING THE A10 TOC MONITOR

The A10 TOC Monitor cleaning is recommended when:

- A new Q-Gard Pack or Quantum Cartridge is installed or
- The TOC values are fluctuating or
- The TOC values are higher than normally seen.

PERFORMING A CLEANING OF THE A10 TOC MONITOR

Follow these steps below to perform an A10 TOC Monitor cleaning.

<p>STANDBY 07 Feb 2006 20:16 Menu → Ready →</p>	<p>Select Menu. Press</p> 	<p>STANDBY MENU Maintenance → Sanitise/Clean → Suitability Tests → Language → Manager Menu →</p>	<p>Select Sanitise/Clean. Press</p> 
<p>SANITISE / CLEAN A10 Cleaning →</p>	<p>Press</p> 	<p>A10 CLEANING See Section 5-7 in the User Manual for more information. Press ✓ to start A10 cleaning or ← to exit.</p>	<p>Press</p> 
<p>A10 CLEANING A10 cleaning procedure in progress. Remaining time: 60 min. Press → to cancel.</p>	<p>A10 CLEANING A10 cleaning procedure in progress. Remaining time: 5 min. Press → to cancel.</p>	<p>When the A10 CLEANING Mode has finished, the Milli-Q System automatically goes into READY Mode.</p>	<p>READY 07 Feb 2006 20:19 Menu → Standby →</p>

Section 5-8 HOW TO CLEAN THE INLET STRAINER

The purpose of the Inlet Strainer is to prevent a large particle from entering the Inlet Solenoid Valve of the Milli-Q System. If the Inlet Strainer becomes clogged, then feedwater does not flow freely to the Milli-Q System.

Note that the Inlet Strainer is used only when the Milli-Q System is fed by a loop.

5-8.1 WHEN TO CLEAN THE INLET STRAINER?

The Inlet Strainer should be cleaned when the following Alert message is displayed. See Section 6-2 for more information about how Alert messages are displayed.

The Inlet Strainer should also be cleaned whenever you suspect it is clogged.





- **Alert message = EXAMINE INLET STRAINER**

5-8.2 CLEANING THE INLET STRAINER

1. Make sure the Milli-Q System is in **READY** Mode.
2. Locate the feedwater supply valve. Turn off the valve.
3. Press the Q-POD Plunger. Dispense water for a few seconds. This depressurises the feedwater tubing. Press the Q-POD Plunger again.
4. Place the Milli-Q System into **STANDBY** Mode.
5. Locate the Inlet Strainer.
6. Unscrew the Inlet Strainer from the feedwater supply. Detach the tubing on the other end of the Inlet Strainer.
7. Flush tap water backward through the Inlet Strainer. Any trapped debris is flushed out.
8. Apply 3 to 4 turns of new white tape to the threads of the feedwater pipe. Apply the tape in a clockwise direction.
9. Screw the Inlet Strainer back onto the feedwater pipe.
10. Attach the tubing to the other end of the Inlet Strainer.
11. Open the feedwater supply valve.
12. Place the Milli-Q System into **READY** Mode. Dispense some water. During this time, check the setting of the feedwater pressure regulator. It should be set to a value between 0.1 bar and 0.3 bar.
13. Leave the Milli-Q System in **READY** Mode.

5-8.3 HOW TO TELL THE MILLI-Q SYSTEM THAT THE INLET STRAINER HAS BEEN CLEANED

The Milli-Q System needs to know that the Inlet Strainer has been cleaned. This resets the **Examine Inlet Strainer** message.

<p>STANDBY 07 Feb 2006 20:29 Menu → Ready →</p>	<p>Select Menu. Press</p>		<p>STANDBY MENU Maintenance → Sanitise/Clean → Suitability Tests → Language → Manager Menu →</p>	<p>Select Maintenance. Press</p>	
<p>MAINTENANCE Clean Strainer → Install Q-Gard → Install UV 185 Lamp → Install Quantum → Install A10 Lamp → Install POD Pak 1 → Install POD Pak 2 →</p>	<p>Select Clean Strainer. Press 2 times on</p>		<p>CLEAN STRAINER See Section 5-8 in the User Manual For more information. Press ✓ after cleaning or ← to exit.</p>	<p>Press</p>	
<p>CLEAN STRAINER The strainer cleaning date is registered. Next maintenance in 182 days. ←</p>	<p>Press 3 times on</p>		<p>STANDBY 07 Feb 2006 20:29 Menu → Ready →</p>		

CHAPTER 6 ALERT AND ALARM MESSAGES

Section 6-1 WHAT ARE ALERT AND ALARM MESSAGES?

6-1.1 WHAT IS AN ALERT MESSAGE?

An Alert message corresponds to a maintenance request. Most of the Alert messages are related to the changing of a consumable.

A list of Alert messages can be found in Section 6-4 of this User Manual.

MINOR ALERT MESSAGE

A minor Alert message corresponds to an early maintenance request. Minor Alert messages usually indicate that a maintenance action is needed within a number of days. An example of a Minor Alert message would be **REPLACE A10 LAMP IN 14 DAYS, REPLACE A10 LAMP IN 13 DAYS** and so forth. If you cancel this Alert message, then it is not shown again, the Yellow LED turns off and the Q-POD Dispenser yellow flashing symbol stops flashing. See Section 6-2 for information about how Alert messages are shown.

See Section 6.2.6 for specific information about cancelling Alert messages.

A cancelled Minor Alert message appears again when the maintenance action is overdue. For example, the Alert message **SERVICE VISIT OVERDUE 1 DAY** automatically appears if this maintenance action is not done.

MAJOR ALERT MESSAGE

A major Alert message corresponds to an immediate maintenance request. See Section 6-2 for information about how Alert messages are shown.

6-1.2 WHAT IS AN ALARM MESSAGE?

An Alarm message is a way of informing you that immediate attention is needed for the Milli-Q System.

A list of Alarm messages can be found in Section 6-5 of this User Manual.

The Milli-Q System can respond in two different ways depending upon the type of Alarm message that is shown. These are described below.

ALARM DOES NOT STOP MILLI-Q SYSTEM

Some Alarms, when displayed, do not automatically stop the Milli-Q System from dispensing water. An example of this is the Alarm message **MILLI-Q INTER T < MIN**. This type of Alarm message can be cancelled for 1 hour by using the Keypad.

ALARM STOPS MILLI-Q SYSTEM

Some Alarms, when displayed, automatically stop the Milli-Q System from dispensing water. An example of this is the Alarm message **QUANTUM CARTRIDGE OUT**. This type of Alarm message can not be cancelled for 1 hour by using the Keypad.

Section 6-2 HOW TO SEE AND CANCEL ALERT MESSAGES

6-2.1 ALERT MESSAGE SHOWN ON THE MAIN DISPLAY

The LCD on the right shows **READY** Mode without an Alert message.

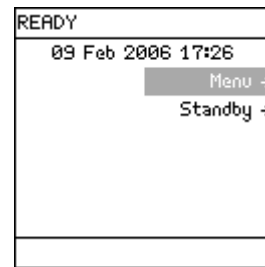

An Alert message is shown on the bottom of the Main Display. In this example, the Alert message **REPLACE A10 LAMP IN 15 DAYS** scrolls across the bottom of the LCD.

The yellow LED is lit steadily when an Alert message is shown.

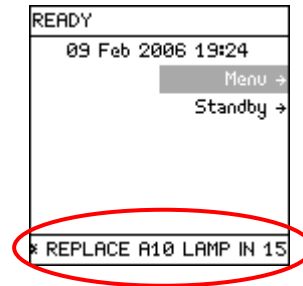

6-2.2 HOW TO READ ABOUT AN ALERT MESSAGE

	<p>Press </p> <p>(2 times in this example) until the Alert message (on the bottom of the LCD) is highlighted.</p>		<p>Press </p> <p>to read about the highlighted Alert message.</p>
	<p>Press </p> <p>to see more of the Alert message text.</p>		<p>Press </p> <p>to exit without cancelling the display of the Alert message.</p>
	<p>See Section 6-2.6 for information about how to cancel the display of an Alert message.</p>		

6-2.3 ALERT SYMBOL SHOWN ON THE Q-POD DISPENSER

The Q-POD Dispenser has a flashing yellow symbol indicating an Alert. The symbol appears in the lower left-hand corner. For your reference, the symbol is circled in the Q-POD Dispenser display shown to the right.

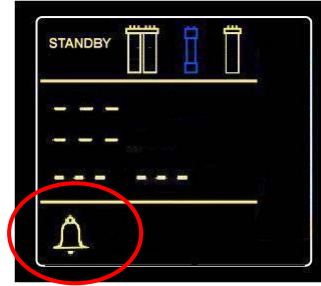

6-2.4 ALERT MESSAGE SHOWN UNDER SYSTEM ALERTS

When an Alert message is shown, then it is listed under the **System Alerts** LCD. To access the System Alerts LCD, see Section 4-8 (**View Operation**) for more information.

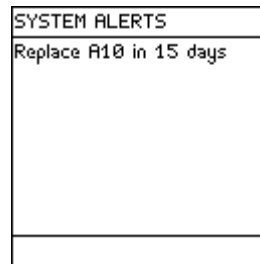

6-2.5 WHAT TO DO WHEN AN ALERT MESSAGE IS SHOWN?

A list of all Alert messages is shown in Section 6-4. This list contains information about how to resolve the Alert message. You can also access some information about an Alert using the Main Display.



You may continue to use the Milli-Q System if an Alert message is shown. The Milli-Q System continues to function normally if an Alert message is shown. If the Alert message indicates that a consumable needs to be replaced, then contact Millipore about ordering a new consumable.

6-2.6 CANCELLING AN ALERT MESSAGE

CANCELLING A MINOR ALERT MESSAGE

A Minor Alert message can be cancelled by:

1. Performing the Maintenance Action (i.e. replace consumable) or
2. Using the Keypad CONFIRM Button (see below) or
3. A Major Alert message is shown. This eliminates the Minor Alert message.

In this example, the Minor Alert message is **Replace A10 Lamp in 15 days**.

<p>The A10 Lamp in the TOC Analyser should be replaced in 15 days. Please make sure to replace it on time for optimal water quality monitoring. See Section 5-6 in the User Manual for more information. Press ✓</p>		<p>Press</p>	<p>The display of the Minor Alert is cancelled.</p>
<p>Now suppose you replace the A10 Lamp.</p>			

Alert and Alarm messages

CANCELLING A MAJOR ALERT MESSAGE

A Major Alert message can be cancelled by:

1. Performing the Maintenance Action (i.e. replace consumable) or
2. Using the Tick Keypad Button (see below). This cancels the display of the Major Alert message for 24 hours.

In this example, the Major Alert message is **Replace A10 Lamp**.

<p>READY 09 Feb 2006 20:53 Menu → Standby →</p> <p>* REPLACE A10 LAMP ***</p>	<p>READY</p>		<p>SYSTEM ALERTS Replace A10 Lamp</p>
<p>The useful lifetime of the A10 Lamp in the TOC Analyser has expired. Please replace it for optimal TOC monitoring operation. See Section 5-6 in the User Manual for more information. Press ✓</p>		<p>Press</p>	<p>The display of the Major Alert is cancelled for 24 hours. It appears again after 24 hours unless the maintenance action is performed.</p>
<p>READY 09 Feb 2006 21:25 Menu → Standby →</p>	<p>READY</p>		<p>SYSTEM ALERTS Replace A10 Lamp</p>
<p>Now suppose you replace the A10 Lamp.</p>			
<p>READY 09 Feb 2006 20:35 Menu → Standby →</p>	<p>READY</p>		<p>SYSTEM ALERTS No Alerts</p>

Section 6-3 HOW TO SEE AND CANCEL ALARM MESSAGES

6-3.1 ALARM MESSAGE SHOWN ON THE MAIN DISPLAY

The LCD on the right shows **READY** Mode without an Alarm message.

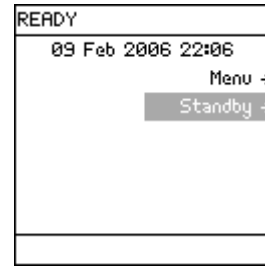

The Alarm message is shown superimposed on the Main Display. In this example, the Alarm message **MILLI-Q T > MAX** is shown.

The red LED is lit steadily when an Alarm message is shown.

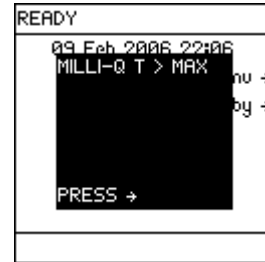

6-3.2 HOW TO READ ABOUT AN ALARM MESSAGE

<p>The LCD display shows the word "READY" at the top. Below it is the date and time "09 Feb 2006 22:06". A large black box is superimposed over the center of the screen, containing the text "MILLI-Q T > MAX" in white. At the bottom of the screen, there is a "PRESS →" prompt. The "Menu →" and "Standby →" options are partially visible behind the black box.</p>	<p>Press</p>	<p>See Section 6-5 in the User Manual for more information. Press \blacktriangledown to cancel the display of this alarm for one hour or press \leftarrow to exit.</p>	<p>Section 6-5 in this User Manual describes the meaning of each Alarm message.</p>
<p>Press</p>	<p>The LCD display shows the word "READY" at the top. Below it is the date and time "09 Feb 2006 22:06". A large black box is superimposed over the center of the screen, containing the text "MILLI-Q T > MAX" in white. At the bottom of the screen, there is a "PRESS →" prompt. The "Menu →" and "Standby →" options are partially visible behind the black box.</p>	<p>See Section 6-3.6 for information about how to cancel an Alarm message.</p>	
<p>to exit without cancelling the Alarm message.</p>			

6-3.3 ALARM SYMBOL SHOWN ON THE Q-POD DISPENSER

The Q-POD Dispenser has a flashing symbol indicating an Alarm. The symbol appears near the lower left-hand corner. For your reference, it is circled in the Q-POD Dispenser display shown to the right.



6-3.4 ALARM MESSAGE SHOWN UNDER SYSTEM ALARMS

When an Alarm message is shown, then it is listed under the **System Alarms** LCD. To access the **System Alarms** LCD, see Section 4-8 (**View Operation**) for more information.

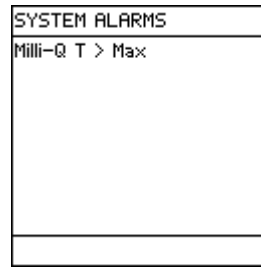

6-3.5 WHAT TO DO WHEN AN ALARM MESSAGE IS SHOWN?

A list of all Alarm messages is shown in Section 6-5. This list contains information about how to understand the cause of the Alarm message.



It is not recommended to use to the Milli-Q System when an Alarm message is shown. See Section 6-5 or contact Millipore when an Alarm message is shown.

6-3.6 CANCELLING AN ALARM STOP MESSAGE

The display of an Alarm Stop message (i.e. **Q-GARD PACK OUT**) can only be cancelled by fixing the cause of the Alarm. **It is not possible to cancel the display of an Alarm Stop message with the Keypad for 1 hour.** For example, the display of the Alarm Stop message **Q-GARD PACK OUT** can not be cancelled for 1 hour by using the Keypad. The Q-Gard Pack would need to be put back in place in order to eliminate this Alarm message.

6-3.7 CANCELLING AN ALARM MESSAGE (MESSAGES THAT DO NOT STOP THE MILLI-Q SYSTEM)

The display of an Alarm message can be cancelled by:

1. Fixing the cause of the Alarm or
2. Using the Keypad CONFIRM Button (see below). **This cancels the display of the Alarm message for 1 hour.** Note that you can not cancel the display of an Alarm that automatically stops the Milli-Q System.

In this example, the Alarm message is **MILLI-Q T > MAX**.

<p>See Section 6-5 in the User Manual for more information. Press ✓ to cancel the display of this alarm for one hour or press ← to exit.</p>	<p>Press</p>	<p>The display of the Alarm is cancelled for 1 hour. It appears again after 1 hour unless the cause of the Alarm message is fixed.</p>	<p>Go to STANDBY Mode and then back to READY Mode. If this is not done, then the Milli-Q System does not dispense water with a cancelled Alarm message.</p>
<p>Now suppose a Millipore Service Representative fixes the Alarm. Go to STANDBY Mode and then back to READY Mode. If this is not done, then the Milli-Q System does not dispense water with a cancelled Alarm message</p>			

Alert and Alarm messages

Section 6-4 SUMMARY OF ALERT MESSAGES AND WHAT TO DO

LCD Messages	Minor or Major Alert	1. What it means. 2. What to do.
CALIBRATION VISIT OVERDUE X DAYS	Major	<ol style="list-style-type: none"> 1. The Milli-Q System has determined that a Calibration Visit is overdue. 2. Contact Millipore.
CHECK UV 185 NM LAMP	Major	<ol style="list-style-type: none"> 1. The UV 185 nm Lamp is not turning on. 2. Contact Millipore.
EXAMINE INLET STRAINER	Major	<ol style="list-style-type: none"> 1. The Milli-Q System has determined that it is time to clean the Inlet Strainer. 2. See Section 5-8.
MILLI-Q FEED CONDUCTIVITY > SP	Major	<ol style="list-style-type: none"> 1. The measured feedwater conductivity is > Set Point. 2. Check the source of feedwater. Check its conductivity. See Section 4-5 for information about viewing the Feed conductivity. See Section 3-16 for Set Point information.
MILLI-Q INTER R < SP, PLEASE ORDER Q-GARD AND QUANTUM	Minor	<ol style="list-style-type: none"> 1. The measured resistivity after the Q-Gard Pack is < Set Point. 2. The Q-Gard Pack and Quantum Cartridge are replaced together. Contact Millipore about ordering a replacement Q-Gard Pack and Quantum Cartridge.
NEXT CALIBRATION VISIT IN XX DAYS	Minor	<ol style="list-style-type: none"> 1. The Milli-Q System is prompting you that a Calibration Visit should be scheduled. 2. Contact Millipore.
NEXT QUALIFICATION VISIT IN XX DAYS	Minor	<ol style="list-style-type: none"> 1. The Milli-Q System is prompting you that a Qualification Visit should be scheduled. 2. Contact Millipore.
NEXT SERVICE VISIT IN XX DAYS	Minor	<ol style="list-style-type: none"> 1. The Milli-Q System is prompting you that a Service Visit should be scheduled. 2. Contact Millipore.
QUALIFICATION VISIT OVERDUE XX DAYS	Major	<ol style="list-style-type: none"> 1. The Milli-Q System has determined that a Qualification Visit is overdue. 2. Contact Millipore.
REPLACE A10 LAMP	Major	<ol style="list-style-type: none"> 1. The Milli-Q System has determined that the A10 Lamp should be replaced. 2. See Section 5-6.
REPLACE A10 LAMP IN XX DAYS	Minor	<ol style="list-style-type: none"> 1. The Milli-Q System is prompting you that the A10 Lamp should be replaced in XX Days. 2. Contact Millipore about ordering a replacement A10 Lamp.

Alert and Alarm messages

LCD Messages in alphabetical order	Minor or Major Alert	1. What it means. 2. What to do.
REPLACE POD PAK N° 1 (or 2 or 3)	Major	<ol style="list-style-type: none"> 1. The Milli-Q System has determined that POD PAK N° 1(or 2 or 3) should be replaced. 2. See Section 5-4.
REPLACE POD PAK N° 1 IN XX DAYS	Minor	<ol style="list-style-type: none"> 1. The Milli-Q System is prompting you that POD Pak N° 1(or 2 or 3) should be replaced in XX Days. 2. Contact Millipore about ordering a replacement POD Pak.
REPLACE Q-GARD PACK	Major	<ol style="list-style-type: none"> 1. The Milli-Q System has determined that the Q-Gard Pack should be replaced. 2. See Section 5-2.
REPLACE Q-GARD PACK IN XX DAYS	Minor	<ol style="list-style-type: none"> 1. The Milli-Q System is prompting you that the Q-Gard Pack should be replaced in XX Days. The Quantum Cartridge should be replaced at the same time. 2. Contact Millipore about ordering a replacement Q-Gard Pack and Quantum Cartridge.
REPLACE QUANTUM CARTRIDGE	Major	<ol style="list-style-type: none"> 1. The Milli-Q System has determined that the Quantum Cartridge should be replaced. 2. See Section 5-3.
REPLACE QUANTUM CARTRIDGE IN XX DAYS	Minor	<ol style="list-style-type: none"> 1. The Milli-Q System is prompting you that the Quantum Cartridge should be replaced in XX Days. 2. Contact Millipore about ordering a replacement Quantum Cartridge.
REPLACE UV 185 NM LAMP	Major	<ol style="list-style-type: none"> 1. The Milli-Q System has determined that the UV 185 nm Lamp should be replaced. 2. See Section 5-5.
REPLACE UV 185 NM LAMP IN XX DAYS	Minor	<ol style="list-style-type: none"> 1. The Milli-Q System is prompting you that the UV 185 nm Lamp should be replaced in XX Days. 2. Contact Millipore about ordering a replacement UV 185 nm Lamp.
SERVICE VISIT OVERDUE XX DAYS	Major	<ol style="list-style-type: none"> 1. The Milli-Q System has determined that a Service Visit is overdue. 2. Contact Millipore.

Alert and Alarm messages

Section 6-5 SUMMARY OF ALARM MESSAGES AND WHAT TO DO

LCD Messages	Alarm stops or does not stop Milli-Q System	1. What it means. 2. What to do.
A10 ERROR 0	Not Alarm Stop	<ol style="list-style-type: none"> A10 PCB E²Prom defective. Unplug the power cord, then plug it in to power on the Milli-Q System. Dispense water for several minutes. If the message continues, then contact Millipore.
<div style="display: flex; align-items: center;"> <div style="border: 1px solid black; padding: 5px; margin-right: 10px;">  <p>ATTENTION</p> </div> <div> <p>If you cancel any A10 ERROR (i.e. A10 ERROR 3) using the Keypad (see Section 6-3.6), go to STANDBY Mode and then back to READY Mode. Dispense water for at least 9 minutes. A new TOC Analysis can not be done during this time. If the new TOC value is satisfactory, then proceed to use the Milli-Q Water. Contact Millipore if the A10 ERROR returns after 1 hour.</p> </div> </div>		
A10 ERROR 1	Not Alarm Stop	<ol style="list-style-type: none"> A10 PCB A/D converter defective. Unplug the power cord, then plug it in to power on the Milli-Q System. Dispense water for several minutes. If the message continues, then contact Millipore.
A10 ERROR 2	Not Alarm Stop	<ol style="list-style-type: none"> A10 Thermistor defective. Unplug the power cord, then plug it in to power on the Milli-Q System. Dispense water for several minutes. If the message continues, then contact Millipore.
A10 ERROR 3	Not Alarm Stop	<ol style="list-style-type: none"> Problem occurred with temperature compensation. Unplug the power cord, then plug it in to power on the Milli-Q System. Dispense water for several minutes. If the message continues, then contact Millipore.
A10 ERROR 4	Not Alarm Stop	<ol style="list-style-type: none"> The water entering the A10 is < 4°C. If the problem can not be resolved, then contact Millipore.
A10 ERROR 5	Not Alarm Stop	<ol style="list-style-type: none"> The water entering the A10 is > 41°C. If the problem can not be resolved, then contact Millipore.
A10 ERROR 6	Not Alarm Stop	<ol style="list-style-type: none"> The conductivity of the water entering the A10 is > 1.1 μS/cm. If the problem can not be resolved, then contact Millipore.

Alert and Alarm messages

LCD Messages	Alarm stops or does not stop Milli-Q System	1. What it means. 2. What to do.
A10 ERROR 7	Not Alarm Stop	<ol style="list-style-type: none"> 1. The temperature inside the A10 during its Analysis Mode exceeded 55°C. Unplug the power cord, then plug it in to power on the Milli-Q System. Dispense water for several minutes. 2. If the message continues, then contact Millipore.
<div style="display: flex; align-items: center; justify-content: center;"> <div style="border: 1px solid black; padding: 5px; margin-right: 10px;">  ATTENTION </div> <div style="text-align: center;"> <p>If you cancel any A10 ERROR (i.e. A10 ERROR 3) using the Keypad (see Section 6-3.6), go to STANDBY Mode and then back to READY Mode. Dispense water for at least 9 minutes. A new TOC Analysis is done during this time. If the new TOC value is satisfactory, then proceed to use the Milli-Q Water. Contact Millipore if the A10 ERROR returns after 1 hour.</p> </div> </div>		
A10 ERROR 8	Not Alarm Stop	<ol style="list-style-type: none"> 1. The TOC sample oxidation was not completed in the allotted time. 2. If the message continues, then contact Millipore.
A10 ERROR 9	Not Alarm Stop	<ol style="list-style-type: none"> 1. The A10 is not detecting a TOC value. This can be caused by: <ul style="list-style-type: none"> • The A10 Solenoid Valve is not closing and could have a particle stuck in it or • The A10 Lamp is not turning on. <p>Perform an A10 Cleaning Mode. This might dislodge a stuck particle or replace the A10 Lamp.</p>
CHECK A10 COM	Not Alarm Stop	<ol style="list-style-type: none"> 1. The communication between the A10 TOC Monitor and the Milli-Q System PC Board is interrupted. The TOC value is no longer reported. 2. Contact Millipore. When this is fixed, dispense water for at least 9 minutes. A new TOC Analysis is done during this time. If the new TOC value is satisfactory, then proceed to use the Milli-Q Water.
FLOW AUTO STOP	Alarm Stop	<p>There are two different reasons for this Alarm. These are listed below.</p> <ol style="list-style-type: none"> 1. The Q-POD Dispenser is not available for dispensing. See Section 4-6. Or The Milli-Q System has automatically stopped dispensing water. The POD FLOW STOP timer has reached 0 minutes. 2. Push the Q-POD Dispenser Plunger all the way down and release. This resets the dispenser timer and makes the Q-POD Dispenser available for dispensing. See Section 3-18.4 for information about changing this timer. See Section 4-6 for more information.

Alert and Alarm messages

LCD Messages	Alarm stops or does not stop Milli-Q System	<ol style="list-style-type: none"> 1. What it means. 2. What to do.
INCORRECT Q-GARD PACK	Alarm Stop	<ol style="list-style-type: none"> 1. The Milli-Q System does not recognise the type of Q-Gard Pack being installed. 2. Contact Millipore.
INCORRECT QUANTUM CARTRIDGE	Alarm Stop	<ol style="list-style-type: none"> 1. The Milli-Q System does not recognise the type of Quantum Cartridge being installed. 2. Contact Millipore.
<div style="display: flex; align-items: center;"> <div style="border: 1px solid black; padding: 5px; margin-right: 10px;">  ATTENTION </div> <div> <p>If you cancel any Alarm related to temperature, resistivity or conductivity measurements (i.e. MILLI-Q FEED C < MIN) using the Keypad (see Section 6-3.6), go to STANDBY Mode and then back to READY Mode. These types of Alarm messages indicate a parameter is measured out of range. It is important to realise the displayed water quality values may be in error. It is your decision to use the Milli-Q Water in this case.</p> </div> </div>		
MILLI-Q FEED C > MAX	Not Alarm Stop	<ol style="list-style-type: none"> 1. The feedwater conductivity is out of measurement range. 2. Contact Millipore.
MILLI-Q FEED T < MIN	Not Alarm Stop	<ol style="list-style-type: none"> 1. The feedwater temperature is out of measurement range. 2. Contact Millipore.
MILLI-Q FEED T > MAX	Not Alarm Stop	<ol style="list-style-type: none"> 1. The feedwater temperature is out of measurement range. 2. Contact Millipore.
MILLI-Q INTER T < MIN	Not Alarm Stop	<ol style="list-style-type: none"> 1. The Intermediate temperature is out of measurement range. 2. Contact Millipore.

Alert and Alarm messages

LCD Messages	Alarm stops or does not stop Milli-Q System	<ol style="list-style-type: none"> 1. What it means. 2. What to do.
<div style="display: flex; align-items: center;"> <div style="border: 1px solid black; padding: 5px; margin-right: 10px;">  ATTENTION </div> <div> <p>If you cancel any Alarm related to temperature, resistivity or conductivity measurements (i.e. MILLI-Q FEED C > MAX) using the Keypad (see Section 6-3.6), go to STANDBY Mode and then back to READY Mode. These types of Alarm messages indicate a parameter is measured out of range. It is important to realise the displayed water quality values may be in error. It is your decision to use the Milli-Q Water in this case.</p> </div> </div>		
MILLI-Q INTER T > MAX	Not Alarm Stop	<ol style="list-style-type: none"> 1. The Intermediate temperature is out of measurement range. 2. Contact Millipore.
MILLI-Q INTERM R > MAX	Not Alarm Stop	<ol style="list-style-type: none"> 1. The Intermediate resistivity is out of measurement range. 2. Contact Millipore.
MILLI-Q RES < SP, REPLACE Q-GARD AND QUANTUM	Not Alarm Stop	<ol style="list-style-type: none"> 1. The Milli-Q Water resistivity is < set point. 2. Replace the Quantum Cartridge and the Q-Gard Pack.
MILLI-Q RES > MAX	Not Alarm Stop	<ol style="list-style-type: none"> 1. The Milli-Q Water resistivity is out of measurement range. 2. Contact Millipore.
MILLI-Q T < MIN	Not Alarm Stop	<ol style="list-style-type: none"> 1. The Milli-Q Water temperature is out of measurement range. 2. Contact Millipore.
MILLI-Q T > MAX	Not Alarm Stop	<ol style="list-style-type: none"> 1. The Milli-Q Water temperature is out of measurement range. 2. Contact Millipore.
MILLI-Q TOC > SP	Not Alarm Stop	<ol style="list-style-type: none"> 1. The TOC is > set point. 2. Contact Millipore.

Alert and Alarm messages

LCD Messages	Alarm stops or does not stop Milli-Q System	<ol style="list-style-type: none"> 1. What it means. 2. What to do.
Q-GARD PACK OUT	Alarm Stop	<ol style="list-style-type: none"> 1. The Q-Gard Pack is not installed correctly or it has been removed. The Milli-Q System stops operating. 2. Verify that the Q-Gard Pack is installed correctly. See Section 5-2.
QUANTUM CARTRIDGE OUT	Alarm Stop	<ol style="list-style-type: none"> 1. The Quantum Cartridge is not installed correctly or it has been removed. The Milli-Q System stops operating. 2. Verify that the Quantum Cartridge is installed correctly. See Section 5-3.
TANK EMPTY	Alarm Stop	<ol style="list-style-type: none"> 1. The Milli-Q System has detected an empty tank. 2. Refill the tank. Verify that the tank level sensor is plugged into the Milli-Q System Cabinet.
WATER DETECTED	Alarm Stop	<ol style="list-style-type: none"> 1. A Water Sensor (an accessory connected to the Milli-Q System) has detected water. The Milli-Q System stops operating. 2. Clean up the spilled water. Make sure the source of the leak is fixed. Go to STANDBY Mode and then go to READY Mode.

CHAPTER 7 ORDERING INFORMATION**Section 7-1 CATALOGUE NUMBERS FOR CONSUMABLES**

CONSUMABLE ITEM	CATALOGUE NUMBER	COMMENTS
A10 Lamp	ZFA10UVM1	1/box
BioPak Ultrafilter	CDUFB1001	1/box
Millipak Express 40 Filter	MPGP04001	1/box (¼ inch GAZ female connection)
Q-Gard T1 Pack	QGARDT1X1	1/box, used for RO, Elix, Milli-RX™, Milli-RO®, distilled feedwaters
Q-Gard T2 Pack	QGARDT2X1	1/box, used for DI, Service DI feedwaters
Q-Gard T3 Pack	QGARDT3X1	1/box, used for DI, Service DI feedwaters with a Fouling Index > 5
Quantum TEX Cartridge	QTUMOTEX1	1/box, Millipak Express 40 Filter not included, used for applications needing trace levels of ions and trace levels of organic species.
Quantum TIX Cartridge	QTUMOTIX1	1/box, Millipak Express 40 Filter not included, used for applications needing trace levels of ions.
UV 185 nm Lamp	ZMQUVLP01	1/box (gloves included)

Section 7-2 CATALOGUE NUMBERS FOR ACCESSORIES

ACCESSORY	CATALOGUE NUMBER
Drop by Drop Device	FLORDC001
Feedwater Conductivity Cell	ZFCONDCL1
Footswitch	ZMQSFTS01
Pressure Regulator	ZFMQ000PR
Q-POD Dispenser for Milli-Q Water (2 nd or 3 rd Q-POD Dispenser)	ZMQSP0D01
Wall Mounting Bracket for Q-POD Dispenser	WMBQPOD01
Wall Mounting Bracket for Water System Cabinet	WMBSMT002
Water Sensor	ZFWATDET4

Section 7-3 CATALOGUE NUMBERS FOR MILLI-Q ADVANTAGE A10 SYSTEM

SYSTEM	CATALOGUE NUMBER
Milli-Q Advantage A10 System	Z00Q0V0T0

A Milli-Q Advantage A10 Water Purification System is designed to use universal voltage (100-230 V ±10%).