



# Streamline

## Watershed Management Bulletin

Volume 8 Number 2 Spring 2005

Introduction to Salt Dilution Gauging for Streamflow Measurement Part III:

## Slug Injection Using Salt in Solution

R.D. (Dan) Moore

### Introduction

Previous Streamline articles introduced the general principles of stream gauging by salt dilution (Moore 2004a) and the procedure for constant-rate injection (Moore 2004b). While constant-rate injection is best suited for use in small streams at low flows (discharges less than about 100 L/s or 0.1 m<sup>3</sup>/s), slug injection can be used to gauge flows up to 10 m<sup>3</sup>/s or greater, depending upon channel characteristics. Slug injection works well in steep, highly turbulent streams, such as the bouldery mountain channel shown in Figure 1. This article introduces the conceptual basis and field procedures for slug injection using salt in solution.

*Slug injection works well in steep, highly turbulent streams.*

### Conceptual Basis

In this approach, a volume of salt solution,  $V$  (m<sup>3</sup>), is injected as a near-instantaneous slug or gulp at one location in the stream. Following injection, the salt solution mixes rapidly throughout the depth of the stream and less rapidly across the stream width as it travels downstream with the general flow of water. Because some portions of a stream flow faster than others (e.g., flow tends to be faster in the centre than near the banks), the cloud of salty water "stretches" downstream in a process called *longitudinal dispersion*. This dispersion results in the cloud having a leading edge with relatively low concentrations of salt solution, a central zone of high concentrations, followed by a trailing edge of decreasing concentration.

If the electrical conductivity (EC) is recorded at some point downstream, where the tracer has been completely mixed across the stream width, the passage of the salt

cloud will cause EC to increase from its background value to a peak value, corresponding to the passage of the core of the cloud, followed by a decline to background EC as the trailing edge of the cloud passes, resulting in a characteristic *salt wave* (Figure 2). Longitudinal dispersion reduces the peak EC of the salt wave as it travels downstream. The time required for the peak of the wave to move past an observation point will depend inversely on the mean velocity of the streamflow, while the duration of the salt wave will depend

*Continued on page 2*

### Inside this issue:

**Introduction to Salt Dilution Gauging for Streamflow Measurement Part III: Slug Injection Using Salt in Solution**

**An Inexpensive, Automatic Gravity-fed Water Sampler for Investigating Water Quality in Small Streams**

**Live Gravel Bar Staking Channel Stabilization in the Lower Elk River**

**A Qualitative Hydro-Geomorphic Risk Analysis for British Columbia's Interior Watersheds: A Discussion Paper**

**Re-creating Meandering Streams in the Central Oregon Coast Range, USA**

**Results of Streamline Reader Survey 2004 Update**

Published by:

**FORREX–Forest Research  
Extension Partnership**  
Suite 702, 235 1st Avenue  
Kamloops, BC V2C 3J4

Project Manager:  
**Robin Pike**  
Tel: (250) 387-5887

Distribution/Mailing List:  
**Janet Jeffery**  
Tel: (250) 371-3923

Technical review committee:  
**R. Scherer, R.D. Moore, R. Pike**

Technical reviewers this issue:  
**S. Babakaiff, L. Barr, R. Doucet, B. Eaton,  
T. Giles, B. Grainger, D. Hutchinson, P.  
Jordan, M. Miles, R.D. Moore, R. Pike, D.  
Polster, P. Raymond, R. Scherer, M.  
Schnorbus, K. Swift, P. Teti, R. Winkler**

Publication and Web Site Support:  
**Jesse Piccin, Satnam Brar, Julie Schooling**

Graphic Layout: **SigZag Design**

Editing: **Ros Penty**

Cover Illustration: **William McAusland**  
McAusland Studios, Kamloops, B.C.

Streamline is published twice a year by FORREX. All articles published in Streamline are reviewed to ensure reliable and technically sound information is extended to our readers. Content published in Streamline reflects the opinions and conclusions of the contributing author(s), not those of FORREX, our editorial staff, or our funding partners. Please contact Robin Pike, Streamline Project Manager, for further guidelines on article submission or with your comments and suggestions.

**This publication is funded in part by the  
British Columbia Ministry of Forests  
through the Forest Investment Account,  
Forest Science Program, and by the  
USDA Forest Service.**

ISSN 1705-5989

Printed in Canada

© FORREX–Forest Research Extension  
Partnership

Printed on recycled paper

<http://www.forrex.org/streamline>



John Heinonen

Figure 1. Place Creek at high flow during summer glacier melt.

on the amount of longitudinal dispersion, which, in turn, depends on how variable the stream velocities are across the stream. The author has found that the time required for the salt wave to pass typically varies from a couple of minutes (e.g., Figure 2) to over 20 minutes. Under low-flow conditions with low velocities, the duration can be longer than desired for accurate measurements (e.g., well over 30 minutes).

At any time ( $t$ ) during the salt wave passage, the discharge of tracer solution  $q(t)$  (L/s or m<sup>3</sup>/s) past the point will be approximated by:

$$q(t) = Q \cdot RC(t) \quad [1]$$

where  $Q$  is the stream discharge (L/s or m<sup>3</sup>/s) and  $RC(t)$  is the relative concentration of tracer solution (L/L) in the flow at time ( $t$ ). Equation [1] assumes that  $q(t)$  is much smaller than  $Q$ , which should be true in virtually all cases. If the tracer discharge is integrated over the duration of the salt wave, and if the stream discharge is constant over that time, then the following equation should hold for a conservative tracer (i.e., one that does not react with other chemicals in the water, bind to sediment, or otherwise change as it flows downstream):

$$V = \int_T q(t) dt = Q \int_T RC(t) dt \quad [2]$$

where  $T$  represents the salt wave duration (s). Equation [2] can be rearranged to solve for  $Q$ :

$$Q = \frac{V}{\int_T RC(t) dt} \quad [3]$$

In practice,  $RC(t)$  is determined at the downstream measurement point at a discrete time interval  $\Delta t$  (e.g., 1 or 5 s), and the integral is usually approximated as a summation:

$$\int_T RC(t) dt \cong \sum_n RC(t) \Delta t \quad [4]$$

where  $n$  is the number of measurements during the passage of the salt wave. The relative concentration can be determined from EC:

$$RC(t) = k[EC(t) - EC_{bg}] \quad [5]$$

where  $EC(t)$  is the electrical conductivity measured at time  $t$ ,  $EC_{bg}$  is the background electrical conductivity of the stream, and  $k$  is a calibration constant. The calibration constant,  $k$ , depends primarily on the salt concentration in the injection solution and secondarily on the chemical characteristics of the streamwater. Combining Equations [3], [4], and [5], the following practical equation can be derived for computing discharge:

$$Q = \frac{V}{k\Delta t \sum_{n} [EC(t) - EC_{bg}]} \quad [6]$$

To apply Equation [6], we need to know  $V$ , the volume of salt solution injected; measure the resulting changes in  $EC$  at intervals of  $\Delta t$  until  $EC$  returns to background levels; and determine the calibration constant,  $k$ .

## Field Procedures

### Choice of a Measurement Reach

Successful application of the slug injection technique requires a stream reach that generates complete lateral mixing in a short distance. Selected reaches should have as little pool volume as possible because the slow exchange of tracer between the pool volume and the flowing portion of the stream will greatly increase the time required for the salt wave to pass. An ideal reach begins with an injection site upstream of a flow constriction (e.g., where the flow narrows around a boulder, promoting rapid lateral

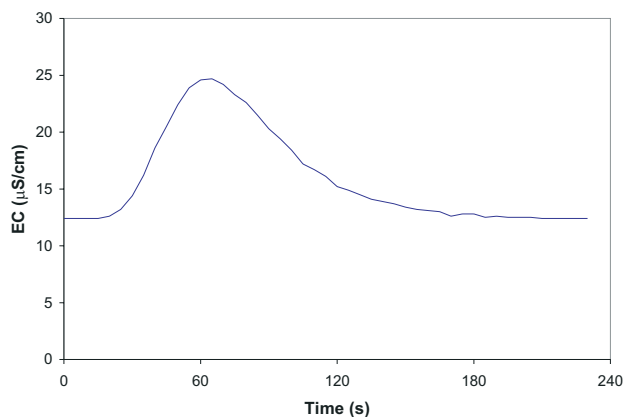

Figure 2. Example of salt wave in Place Creek.

mixing) and contains no pools or backwater areas below the constriction. A rough guideline is that the mixing length should be at least 25 stream widths, but complete mixing may require much longer or shorter distances, depending on stream morphology (Day 1976).

### Mixing the Injection Solution

We use NaCl (table salt) as a tracer because it is inexpensive and readily

available. In addition, the salt concentrations and durations of exposure normally involved in discharge measurement are less than thresholds associated with deleterious effects on organisms (Moore 2004a). Wood and Dykes (2002) observed transient increases in invertebrate drift during slug injection, but concluded that salt injection had a relatively short-term effect and is unlikely to have any long-term deleterious impacts on invertebrate communities at most locations.

The salt concentration in the injection solution should be high enough to increase  $EC$  reasonably when using volumes of solution that can be easily handled, but it also needs to remain less than the solubility. Given the low temperatures often associated with field conditions, the maximum concentration that will dissolve readily is about 20%, or about 1 kg of salt in 5 L of water (Østrem 1964; Kite 1993). We have found that a mixture of 1 kg of salt with 6 L of water (roughly a 17% solution) provides a

suitable compromise between strength and ease of dilution.

The injection solution does not need to be mixed from local streamwater. Where access to the stream does not involve a long hike, it is often convenient to pre-mix the

injection solution to allow generous time for dissolution and to minimize time spent at the field site.

Note that the volume of the injection solution will be greater than the volume of water used to mix it. We have found that when a 1-kg box of salt is mixed with 6 L of water, the resulting solution has a volume of 6.36 L ( $\pm 0.01$  L). Commonly, the salt

solution is mixed in one container then decanted into a second, pre-calibrated container (e.g., Østrem 1964). This procedure ensures that the salt in the injection solution is completely dissolved, and allows accurate measurement of the injection volume.

### Required Volumes of Injection Solution

The accuracy of a measurement depends on how much  $EC$  increases above background during the salt wave passage, relative to the accuracy of the conductivity probe. The change in  $EC$  during the salt wave passage depends, in turn, on the volume of salt solution and its concentration, as well as the mixing characteristics of the stream. Those streams with less longitudinal dispersion will exhibit a more peaked salt wave with higher concentrations, and will require lower injection volumes.

Kite (1993) suggested that peak  $EC$  should be 50% higher than background, while Hudson and Fraser (2002) suggested that peak  $EC$  should be at least 5 times higher than background. Background  $EC$  in B.C. streams typically ranges from about 10  $\mu\text{S}/\text{cm}$  for stormflow conditions in streams draining catchments underlain by granitic bedrock, to over 400  $\mu\text{S}/\text{cm}$  for low-flow conditions in streams sustained by groundwater discharge. The author suggests that increasing  $EC$  by 100–200% of background should be adequate for streams with low background  $EC$  (less than about 50  $\mu\text{S}/\text{cm}$ ), while Kite's (1993) guideline should be reasonable for streams with background  $EC$  greater than about 100  $\mu\text{S}/\text{cm}$ .

Table 1 summarizes the masses/volumes of injected salt/salt solution used by various authors. The range reflects the diversity of channel morphologies and discharges encountered in the different studies. The author recommends starting with 1 L of 15–20% solution per  $\text{m}^3/\text{s}$ . Greater volumes of injected salt

Continued on page 4

solution may be appropriate for wider streams that require longer mixing reaches, while lower volumes may work for narrower streams. To avoid excessive salt concentrations in the stream, one or more trial injections should be conducted with low volumes, working up to larger volumes as required.

placed cobbles) so that it will not move during the measurement. To position the probe in a strong current, it may be useful to attach the probe to a rod weighted at the end that is placed in the water.

In some cases, the background EC may vary. One possible cause is an overly sensitive conductivity meter.

detailed description of the procedure and the calculation of  $k$ .

Although ideally the calibration is performed in the field, particularly to maintain water temperature as close to stream temperature as possible, it can also be conducted in the laboratory. To perform the calibration off site, two 1-L samples of streamwater should be measured accurately into sample bottles using a volumetric flask. A sample of the injection solution should also be taken in a small glass (not plastic) bottle to avoid potential problems with salt sorbing onto the walls of a plastic bottle. The calibration can then be conducted following the procedure described by Moore (2004b).

## Summary of Field Procedures

Table 2 lists the equipment required. Suggested steps for conducting field measurements are as follows:

1. Mix injection solution (either at office or on site).
2. Select measurement reach.
3. Use a pipette to extract a known volume of injection solution (e.g., 10 mL) and add to the secondary solution bottle. Cap the bottle and store upright.
4. Record background EC and water temperature at the downstream end of the measurement reach, and upstream of the injection point.
5. Set up the conductivity probe at the downstream end of the mixing reach. Record the background EC and water temperature. If you have a data logger, start recording EC.
6. Inject a known volume of salt solution at the upstream end of the mixing reach.
7. Record the passage of the salt wave, continuing until EC returns to background. If EC does not return to background, measure EC upstream of the injection point again to determine whether the background changed.

Author	Mass of salt injected per m <sup>3</sup> /s streamflow (kg)	Equivalent volume (L) of 20% salt solution (1 kg salt in 5 L water)
Østrem (1964)	0.5	2.5
Church and Kellerhals (1970)	0.2	1
Day (1976)	0.3	1.5
Elder <i>et al.</i> (1990)	5	25
Hudson and Fraser (2002)	2	10

Figure 2 illustrates a salt wave for Place Creek, where the author has found the salt waves to be highly reproducible. Injecting 6.35 L of a roughly 17% solution into a flow of 2.66 m<sup>3</sup>/s produced a peak EC about 100% higher than background.

### Recording Electrical Conductivity

Ideally, a data logger should be used to record the passage of the salt wave. Some conductivity meters have built-in data logging, while others can output a signal that can be recorded using a separate data logger. If you do not have data logging capacity, record EC manually at 5-s intervals. Although this approach may not be as accurate as using a data logger and a 1-s recording interval, it can produce satisfactory results. In most cases, two people are required to conduct a salt dilution measurement with manual recording, while the use of a data logger allows a single person to make the measurement.

The conductivity probe should be placed within the main part of the flow, not in a backwater. Avoid locations with substantial aeration, as air bubbles passing through the probe cause spurious drops in conductivity. The probe should be firmly emplaced (e.g., by wedging it between carefully

Another cause of varying background EC is incomplete mixing of streamwater and groundwater (which typically has higher EC than the streamwater) within and immediately downstream of groundwater discharge zones. Similar problems with incomplete mixing can occur downstream of tributaries. In these latter cases, find an observation point where background EC is uniform across the channel and constant in time.

### Determining $k$ by Calibration

To determine  $k$ , a known volume of injection solution (typically 5 or 10 mL) is added to a known volume of streamwater (typically 1 L) to produce a secondary solution. Known increments of this secondary solution are then added to a second known volume of streamwater (typically 1 L), to generate a set of EC values corresponding to different values of relative concentration. The slope of the relation between relative concentration and EC provides the required value for  $k$ . This two-step procedure dilutes the injection solution to the relative concentrations observed during the salt wave without using large volumes of streamwater. See Moore (2004b) for a more



**8.** Measure a volume  $V_0$  (e.g., 1 L) of streamwater using the volumetric flask and pour into the secondary solution bottle, which already contains the sample of injection solution. Cap the bottle and shake vigorously to mix the streamwater and injection solution. This mixture is the secondary solution.

**9.** Measure a volume  $V_c$  (e.g., 1 L) of streamwater using the volumetric flask and pour into the calibration tank. Immerse the calibration tank in a shallow pool at the stream's edge. Keep the temperature in the tank as close to stream temperature as possible (Moore 2004b). To help hold the calibration tank in place, position a "corral" of cobbles around it.

**10.** Perform the calibration and determine  $k$  using the procedure described by Moore (2004b), then compute the discharge using Equation [6].

### Errors and Limitations

Under suitable conditions, streamflow measurements made by slug injection can be precise to within about  $\pm 5\%$  (Day 1976). Accurate measurements require that (1) the salt in the injection solution be completely dissolved, and (2) the injection solution be fully mixed across the channel at the location

*Under suitable conditions, streamflow measurements made by slug injection can be precise to within about  $\pm 5\%$ .*

streamwater, injection solution, and secondary solution. These errors can be effectively minimized if a volumetric flask is used to measure streamwater and glass pipettes used to measure the injection and secondary solutions. However, take

where the salt wave is recorded. In addition, discharge should not change appreciably during the injection trial.

Errors may arise through inaccuracies in measuring the volumes of

plasticware into the field as a backup in case of breakage.

If it is raining during the measurement, ensure that the calibration tank is sheltered. Otherwise, rain falling into the tank may dilute the concentrations below the calculated values, producing biased calibrations.

The slug injection method may not be appropriate when the channel contains ice and (or) snow. In such cases, low velocities may result in poor lateral mixing and excessively long salt wave durations, particularly if salt solution flows into slush zones within the measurement reach.

The method will be subject to substantial errors if the measurement

*Continued on page 6*

### Worked Example

Figure 2 shows a salt wave recorded during a slug-injection measurement at Place Creek, located about 30 km northeast of Pemberton, B.C. Place Creek, a steep, bouldery mountain stream, would be impossible to gauge accurately using a current meter (Figure 1). The volume of injection solution was 6.35 L. This volume resulted from mixing 1 kg of salt with 6 L of water (to produce 6.36 L of solution), followed by extracting 10 mL (0.01 L) of injection solution for use in the calibration procedure. The stream EC data were logged at 1-s intervals, and the calibration constant was  $2.99 \cdot 10^{-6} \text{ cm}/\mu\text{S}$ .

$$Q = \frac{V}{k \Delta t \Sigma [EC(t) - EC_{bg}]} = \frac{6.35 \cdot 10^{-3} \text{ m}^3}{(2.99 \cdot 10^{-6} \text{ cm}/\mu\text{S})(1 \text{ s})(797 \mu\text{S}/\text{cm})} = 2.66 \text{ m}^3/\text{s}$$

**Table 2. Equipment list for field measurement of streamflow using slug injection of salt**

Item	Purpose
1-L volumetric flask	Measuring streamwater
1-L plastic graduated cylinder	Backup in case volumetric flask breaks
Plastic measuring cup with handle	Pouring streamwater into volumetric flask
Squirt bottle	Topping up streamwater in volumetric flask
5- and 10-mL pipettes <sup>1,2</sup>	Measuring injection solution to mix secondary solution
Pipette filler (rubber squeeze bulb)	Drawing water into pipettes
1- or 2-L wide-mouth Nalgene water bottle	Mixing the secondary solution
1- or 2-L Nalgene beaker or pail	Calibration tank
2-, 5-, and 10-mL pipettes <sup>1,2</sup>	Measuring secondary solution
Plexiglas rod or tubing, 30 cm long	Stir stick for calibration tank
Conductivity probe and meter	Measuring EC during salt wave passage and for calibration
Data logger (desirable but optional)	Recording EC during salt wave passage

<sup>1</sup>Separate sets of pipettes need to be used for measuring the injection and secondary solutions.

<sup>2</sup>Spare pipettes should be carried in case of breakage in the field. In addition, 10-mL plastic graduated cylinders or graduated pipettes could be carried as backups

reach is not sufficiently long to ensure complete lateral mixing. Unlike constant-rate injection, where lateral mixing can be verified once steady-state conditions have been achieved, assessing mixing is more difficult with slug injection. If two probes are available, then the salt wave can be recorded at two downstream distances or on either side of the stream. If mixing is complete, discharge calculated from both probes should be in reasonable agreement. If this is not the case, a longer mixing reach is required. Alternatively, if only one probe is available, successive measurements can be made during periods of steady flow using different distances.

Problems can occur if the conductivity does not return to background. If the measurements taken upstream show that the background has truly changed, then an average of the original and final background values may be used in Equation [6]. It is more problematic if EC has not returned to background due to a slow release of stored salt solution within the mixing reach, as can occur in reaches with pools, particularly at lower flows. In such cases, one solution would be to extend the tail of the salt wave by fitting an exponential decline to the values, although the actual form of the decline will still be uncertain (Elder *et al.* 1990). Ideally, one should find a reach with minimal storage.

### Injection of Salt in Solution Versus Injection of Dry Salt: A Comparison

A number of authors have advocated the use of dry salt injection as an alternative to injection of salt in solution (Hongve 1987; Elder *et al.* 1990; Kite 1993; Hudson and Fraser 2002). A future *Streamline* article will focus on streamflow measurement by dry salt injection. The key advantage of the method is that, for gauging

higher flows (e.g., >5–10 m<sup>3</sup>/s), it is easier to inject dry salt than to mix and inject adequate volumes of solution. However, a disadvantage of the dry salt method is that an accurate scale to measure the mass of salt or an adequate supply of pre-weighed salt in a range of quantities is needed. Where an accurate scale and pre-weighed quantities of salt are unavailable (e.g., at a remote site over an extended field season), the slug injection method using salt solution would still be possible because the precise mass of salt in the injection solution does not need to be known, just the volume of the solution (Equation [6]).

### Summary

Streamflow measurement by slug injection of salt solution has been successfully applied in many locations around the world. It is particularly suitable for steep, bouldery mountain streams, which are unsuitable for gauging by conventional current metering techniques. This article has described procedures that the author has found useful at sites throughout British Columbia. However, there is great scope to vary the details to suit individual circumstances and users are encouraged to experiment with the outlined procedure.

### Acknowledgements

George Richards helped me experiment with variations on the slug injection method while working at Place Creek. Tim Giles, Dave Hutchinson, Scott Babakaiff, and John Heinonen helped refine the methods by asking valuable questions and bringing relevant articles to my attention. Comments on earlier versions of this article by John Heinonen, Russell White, Michael Church, Robin Pike, and four anonymous reviewers helped improve its clarity. However, any errors remain my sole responsibility. ~

### For further information, contact:

**Dan Moore, Ph.D., P.Geo.**

Associate Professor  
Departments of Geography and Forest Resources Management

1984 West Mall  
University of British Columbia  
Vancouver, BC V6T 1Z2

**Tel: (604) 822-3538**

**E-mail: rdmoore@geog.ubc.ca**

### References

- Church, M. and R. Kellerhals. 1970. *Stream gauging techniques for remote areas using portable equipment*. Department of Energy, Mines and Resources Inland Waters Branch, Ottawa, Canada. Technical Bulletin No. 25.
- Day, T.J. 1976. *On the precision of salt dilution gauging*. *Journal of Hydrology* 31:293–306.
- Elder, K., R. Kattelmann, and R. Ferguson. 1990. *Refinements in dilution gauging for mountain streams*. In *Hydrology in Mountainous Regions. I - Hydrological Measurements; the Water Cycle*. International Association for Hydrological Science (Proceedings of two Lausanne symposia, August 1990). IAHS Publication No. 193, pp. 247–254.
- Hongve, D. 1987. *A revised procedure for discharge measurements by means of the salt dilution method*. *Hydrological Processes* 1:267–270.
- Hudson, R. and J. Fraser. 2002. *Alternative methods of flow rating in small coastal streams*. B.C. Ministry of Forests, Vancouver Forest Region. Extension Note EN-014 Hydrology. 11 p.
- Kite, G. 1993. *Computerized streamflow measurement using slug injection*. *Hydrological Processes* 7:227–233.
- Moore, R.D. 2004a. *Introduction to salt dilution gauging for streamflow measurement: Part 1. Streamline Watershed Management Bulletin* 7(4):20–23.
- Moore, R.D. 2004b. *Introduction to salt dilution gauging for streamflow measurement Part II: Constant-rate injection*. *Streamline Watershed Management Bulletin* 8(1):11–15.
- Østrem, G. 1964. *A method of measuring water discharge in turbulent streams*. *Geographical Bulletin* 21:21–43.
- Wood, P.J. and A.P. Dykes. 2002. *The use of salt dilution gauging techniques: ecological considerations and insights*. *Water Research* 36:3054–3062.

# An Inexpensive, Automatic Gravity-fed Water Sampler for Investigating Water Quality in Small Streams

Chad D. Luider, P. Jefferson Curtis, Rob A. Scherer, and David J. Arkininstall

## Introduction

Water samples are commonly collected, either manually (grab samples) or with automated samplers, in many environmental monitoring and research programs (e.g., Toews and Gluns 2003; Winkler *et al.* 2004). Manual sampling in remote areas can be labour intensive and time consuming, whereas the price of automated samplers (around \$4,000) may be prohibitive to many monitoring programs.

This article describes a low-cost (< \$600 per unit), gravity-fed, automated water sampler (auto-sampler) that can collect water samples from small streams less than 5 m in bankfull width. The auto-sampler is best suited to collect samples for analyses of water quality measures in the dissolved phase, such as pH, conductivity, carbon, phosphorus, and ammonia. Sediment samples have not yet been collected with the auto-sampler, and therefore sediment sampling is not considered in this article.

## Auto-Sampler Components and Design

A simple, lightweight gravity-fed auto-sampler can be constructed from commonly available irrigation supplies. The sampler consists of a water intake system, a valve manifold system, and a series of standard sample bottles (Figures 1 and 2). The water intake system (Figure 3) is

constructed from a PVC pipe with a piece of screen mesh secured on the intake end to minimize large debris from clogging the lines and valves. The opposite end of the PVC intake pipe is connected to a 3–6 m length of polyethylene pipe that forms the main water supply line. The valve manifold system distributes streamwater from the intake pipe through electronically controlled valves into individual sample bottles (Figure 3). A plastic cargo box is used to contain the valves, the sample containers, and the sealed battery-operated control timer, which is programmed to control the electronic valves. Flexibility in sampling depends on the number of valves in the manifold and the features associated with the control timer. Electronic control timers typically control 4–12 valves, and can be connected in series to increase the number of samples that the auto-sampler can collect. For example, two timers controlling 12 valves each could be connected in series and programmed to collect a total of 24 samples from the same sample site.

Desirable features in a control timer include the ability to independently program each valve, a 30-day programmable clock, and a master valve option. Independent programming for each valve is essential because each valve

represents one sample. A 30-day programmable clock allows for flexibility in sample scheduling (e.g., daily, weekly, or monthly). The master valve option (a valve that opens whenever a sample valve is opened) is adaptable to control small pumps where a gravity-fed approach is not feasible (e.g., lakes, ponds, large rivers). We are presently developing an automated pump sampler for this purpose.

## Installation

The auto-sampler should be installed outside of bankfull width to avoid damage during high flows. The intake should be installed securely (e.g., wedged between rocks, fastened to rebar) within the streambed upslope from the auto-sampler, with enough hydraulic head (e.g., 1–2 m of vertical rise) for the gravity-fed intake system to function properly. For our

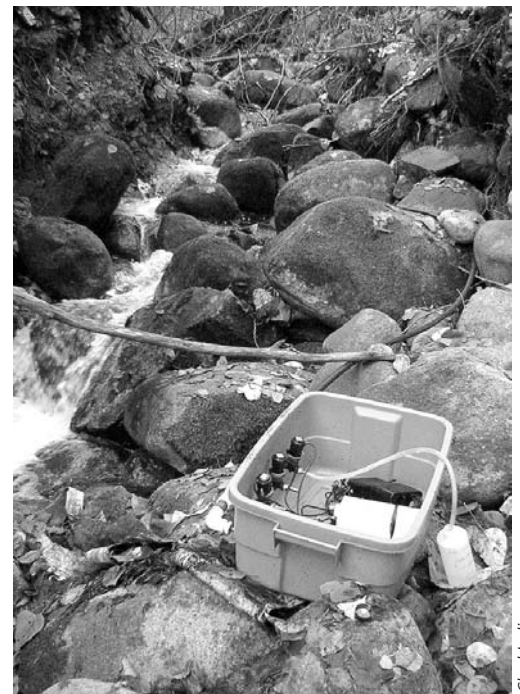

Figure 1. Auto-sampler setup adjacent to creek.

applications we have chosen ¼-inch valves although ½- or ¾-inch valves can be used. Less hydraulic head is required for smaller valves compared with the larger valves, which require higher minimum operating pressures,

*Continued on page 8*

and therefore more hydraulic head. Except for the valves and the solenoid plungers, the entire system could be made from stainless steel, polyethylene, or Teflon where these materials are recommended for use in sampling different water quality parameters.

Upon securing the intake within the stream, the following points should be considered to minimize the potential for air locks in the water supply line

the internal plumbing of the system with sample water. As the manual flush valve is larger than the ¼-inch sample valves, the flow rate is higher and thus the intake system flushes thoroughly.

Due to the design of the sampler, clogged intake screens can significantly affect the operability of the unit. Clogged intake screens can be minimized by positioning the intake screen perpendicular to

bottles will depend on the flow rate through the intake system. Similarly, the automated flush valve should be set to rinse the entire volume of the system at least 5 times immediately before sample collection. The amount of time required to flush the intake system can be calculated empirically by measuring flow rate through the system and the length of the main water supply line that is required for installation. For example, it would take 5 minutes to completely flush the volume of the intake line once given a flow rate of 1 L/min through 10 m of ½-inch intake line (volume of intake line is about 5 L; i.e., flushing time = volume of pipe/flow rate). The time required for sample collection can be calculated using the same approach (i.e., sample collection time = bottle volume/flow rate), but it is best to set the clock for more time than is required to account for decreases in flow rates. This approach ensures that sample bottles are completely filled and are flushed with sample water. Any excess water spilling from the sample bottles drains via holes in the bottom of the plastic cargo box.

### Sample Collection Protocol

We designed and deployed the auto-sampler to collect specific water quality parameters. Therefore, this article will not detail sampling protocol, which varies with water quality parameter of interest. For further information regarding the design of reliable monitoring programs using automated samplers, refer to the *Automated Water Quality Monitoring Field Manual* (Resource Inventory Committee 1999).

### Unit Performance

We used two quality control (QC) measures to evaluate the precision and performance of the auto-sampler. The first QC measure included the direct collection of water samples (i.e., grab samples) at the auto-sampler intake in conjunction with samples being collected with the auto-sampler. The second QC measure was used to

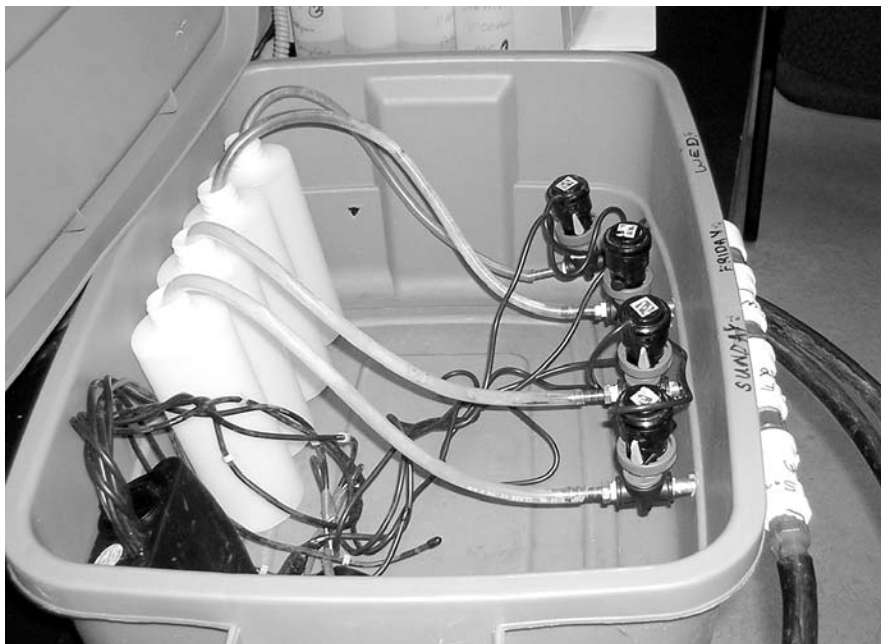

Figure 2. Auto-sampler components and parts.

and clogging of the intake screen. Air locks tend to occur in high points of the main intake line, particularly in highly aerated sections of stream. Intake lines should therefore be installed with a constant slope to the valve manifold, thus avoiding loops in the line that trap air. In addition, the intake screen should be submerged in non-turbulent, uniformly flowing water to minimize air bubbles entering the system. A ball valve at the lower end of the valve manifold should also be installed so that the intake lines can be manually flushed after installation and when changing the sample bottles (Figure 3). This flush allows water to flow through the intake lines to remove air and rinse

streamflow and by designating one valve to flush the system immediately before activating the sample valves. Flushing the intake system immediately before sample collection greatly reduces the risk of the intake becoming plugged or blocked with debris by comparison to a continuous flow setup. The system flush is programmed to be completed within less than 1 minute before activating the valve for sample collection.

After the unit has been installed and the control timer set, sample bottles are connected to the spouts of the valves designated for sample collection with a piece of tubing and a two-holed stopper. The time required on the control timer to fill the sample



evaluate whether leaching from and adsorption to the water intake system was contaminating water quality samples. We checked this by flushing deionized water through the auto-sampler at the end of the sample season. We then compared these samples with control samples of

deionized water. Analyses of pH, conductivity, dissolved organic carbon, and dissolved nutrients ( $\text{PO}_4$  and  $\text{NH}_4$ ) indicate no significant difference between the grab samples, the deionized water, and samples from the auto-sampler ( $p < 0.05$ ).

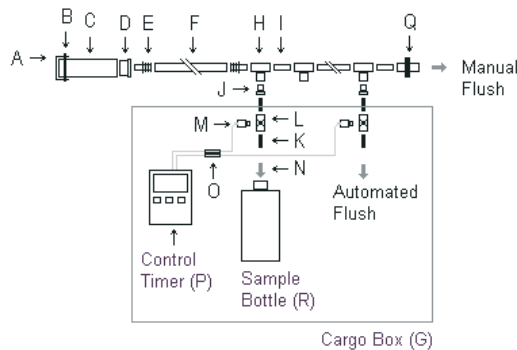

Figure 3. Schematic view of the auto-sampler. The labelled parts are listed in Table 1.

Table 1. Equipment list for a five-bottle auto-sampler

Water intake system		
Item		Quantity
A	Screen mesh (10 x 10 cm)	1
B	2" gear clamp	1
C	2" PVC pipe	~30 cm
D	2" x 1/2" reducer bushing	1
E	1/2" threaded x 1.5 cm (1/2") barbed coupler	1
F	1/2" polyethylene pipe	3–6 m
Valve manifold system		
Item		Quantity
G	Plastic cargo container with lid	1
H	1/2" PVC threaded tee	6
I	1/2" x 2" threaded coupler	6
J	1/2" x 1/8" reducer bushing	6
K	1/8" x 2" brass nipple	12
L	1/4" valve	6
M	Solenoid	6
N	1/4" vinyl tubing	100–150 cm
O	1/4" thick-walled heat shrink	25–30 cm
P	Battery-operated control timer	1
Q	1/2" threaded PVC manual ball valve	1
R	500-mL polyethylene sample bottle	1–6

## Applications and Constraints of the Auto-Sampler

In our study, we deployed and tested three auto-samplers for seven months (April to October 2004) in the Southern Interior of British Columbia. Units were installed in boulder–cobble streams with bankfull widths ranging between 1 and 4 m and gradients between 5 and 15%.

Samples were collected from the units at a rate of 2–3 samples per week and during our field trials we found that required maintenance to the auto-samplers was minimal. Only one repair was required to a broken fitting, which caused the loss of one sample. On average, the two 9V batteries in each control timer were depleted by only 20% throughout the entire operation. All three auto-samplers were removed in late October due to freezing of the valves and intake lines.

The auto-sampler unit is aptly suited for our monitoring purposes (i.e., chemical water quality parameters, low summer flows, ice free conditions). However, the auto-sampler has not been tested or used under the following conditions that would warrant further

investigation and possibly design modifications: (1) high flows and freshet, (2) sediment sampling, (3) freezing conditions, and (4) streams greater than 5 m bankfull width.

In summary, the auto-sampler has allowed us to collect water samples at a higher frequency relative to manual sampling and at a reduced cost compared with commercially available auto-sampler units. Our auto-sampler performed very well during low summer flows and allowed us to collect and analyze water samples for several dissolved water quality parameters. The auto-sampler was reliable, cost effective, and easy to maintain. Future testing and improvements to the design of the auto-sampler will likely increase its suitability to more diverse sampling environments and a greater variety of water quality parameters.

### For further information, contact:

#### P. Jeff Curtis

Department of Earth and Environmental Sciences  
Okanagan University College

3333 University Way  
Kelowna, BC  
V1V 1V7

Tel: (250) 762-5445, Ext 7521

E-mail: jcurtis@ouc.bc.ca

### References

- Resource Inventory Committee. 1999. *Automated water quality monitoring, field manual. Unpublished report prepared for B.C. Ministry of Environment, Lands and Parks, Water Management Branch for the Aquatic Inventory Task Force.* 61 p. Available from: <http://srmwww.gov.bc.ca/risc/pubs/aquatic/index.htm>
- Toews, D. and D. Gluns. 2003. *Water quality sampling: an effective way to monitor watershed condition? Streamline Watershed Management Bulletin 7(2):15–21.*
- Winkler, R., D. Spittlehouse, T. Giles, B. Heise, G. Hope, and M. Schnorbus. 2004. *Upper Pentiction Creek: how forest harvesting affects water quantity and quality. Streamline Watershed Management Bulletin 8(1):18–20.*

# Live Gravel Bar Staking Channel Stabilization in the Lower Elk River

Iain D. Cuthbert and Ian D. Redden

During the past 70 years, the Elk River on northern Vancouver Island has evolved from a narrow, single-thread, stable channel to a wide multi-thread, laterally unstable, aggraded channel. This change was in response to several factors including: valley-bottom logging; channel relocation due to road construction; a large landslide in the river's headwaters; and increased flows resulting from the diversion of water into the Elk River from the adjacent Heber River watershed. The net result: a 4–7 times increase in the unvegetated channel width in the lower 13 km of river and degraded fish habitat because pools infilled, banks eroded, and cover was lost.

Previous channel morphology studies (e.g., M. Miles and Associates 1999) demonstrated the need to restore channel processes in the lower Elk River to expedite the re-formation of a stable, single channel. This project addresses this recommendation and does not incorporate any upland restoration activities that likely will be part of future restoration plans. Based on successful treatments of rivers with similar conditions, such as the San Juan (Switzer 1999), we chose the soil bioengineering technique of live gravel bar staking as the preferred restoration method to achieve our objective. This article describes the application of and lessons learned from live gravel bar staking in the lower Elk River.

## Live Gravel Bar Staking: Background

Live staking of gravel bars using willow (*Salix* spp.) and other plant species such as red-osier dogwood (*Cornus stolonifera*) and black cottonwood (*Populus trichocarpa*) can be used to treat river channels that have become aggraded and braided. In live staking, cuttings (stakes) from the selected pioneering species are planted at high density into the gravel bars.

During high flows, the treated areas are inundated; the friction caused by the protruding stakes traps very small woody debris and leads to local deposition of sediment. Each winter, once enough sediment is deposited to cover the protruding stakes, streamflow will top the bars without resistance. In the next growing season, the cuttings will grow and protrude above the gravel bar. This seasonal process of growth followed by sediment and debris accumulation causes the gravel bars to progressively stabilize and elevate (Figure 1). At the same time, the accumulation of fines and organics, such as small woody debris, promotes the establishment of additional riparian vegetation, further stabilizing the bars. Over time the gravel bars elevate, and become inundated less frequently. The streamflow becomes increasingly confined to the main channel, redirecting the river's energy to scouring a narrower and deeper

mainstem channel. Polster (1999) discusses live gravel bar staking and other soil bioengineering techniques in detail.

## Site Selection

The Elk River, a tributary to Upper Campbell Lake, is located on northern Vancouver Island near the town of Gold River, B.C. The potential treatment sites were first selected by analyzing historical air photos from 1931 to 1995. The main site selection criteria were gravel bars (1) with easy equipment access, (2) in incipiently stable depositional areas, and (3) outside of the most active channel sections that convey high flows. Criteria 2 and 3 were extremely important as live gravel bar staking of the more active channel sections could reduce flood conveyance capacity and possibly accelerate bank erosion or channel shifting (M. Miles and Associates 2004).

### Ongoing Riparian Establishment & Sand and Gravel Storage

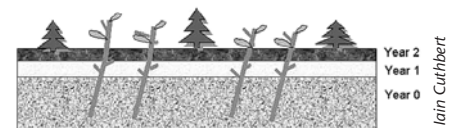

Figure 1. Function of live gravel bar staking.

A June reconnaissance trip finalized restoration site selection, determined site access, and located suitable stock donor and soaking sites. During this trip we discovered that the natural recovery of many of the potential sites identified on the air photos was significant, and included deciduous trees older than 5 years. We theorized that this recovery, the greatest in the previous 45 years, was due to several years with unusually wet summers and smaller than average flood flows. The natural recovery observed was vigorous enough to eliminate several of the potential treatment sites. Thus, three additional sites not identified in



Ian Redden

**Figure 2. Assembling limbed poles into bundles.**

the office review were investigated in the field.

While many areas would have benefitted from live gravel bar staking, site access became the largest limiting factor. Although Highway 28 parallels much of the river, steep banks from the highway prevented equipment from accessing the river. The only other road in the area that would have provided access to the river had been deactivated for much of its length. As most of the lower river lies within Strathcona Provincial Park, excavator access trail building needed to be minimized to preserve ecological values. In total, three sites were selected for treatment.

### Collecting and Preparing the Stakes

The project began in September 2004 with the collection of donor stock from areas close to the restoration sites in Strathcona Park. Stock was collected by cutting down small deciduous trees close to the ground with chainsaws. The donors would coppice and regenerate in the following year. The stakes collected were comprised of 85% willow (Scouler's and Sitka), 6% black cottonwood, and 9% red-osier dogwood. Crew members then

collected, topped, and limbed the cut trees. Using high quality, relatively expensive pruning and lopping shears was invaluable, as smaller shears tended to break, disrupting production. The topped and limbed "poles," which ranged from 2 to 4 m in length, were then placed on sawhorses and tied with biodegradable sisal baling twine into bundles of 7–10 stems (Figure 2). Flagging tape was attached to each bundle, with a different colour used for each day. When the weather conditions were cool and wet, bundles were loaded into trucks and taken to the soaking site at the end of each day. During warmer, sunny weather, bundles were taken to the soaking sites throughout the day to prevent desiccation (wilting) and death. The use of a Silva cool-tarp to cover the bundles during collection would have been beneficial during hot, dry weather. Production averaged 2840 stakes per day for a seven-person crew.

The target size for stake collection was 2 cm in diameter or larger. This size is often referred to as the "rule of thumb" as typically anything greater in diameter than your thumb is the desired size. After several days of harvesting it became apparent that

the main cutting site would not provide enough stock to plant the treatment areas, and two additional donor sites were located. Also, a limited quantity of stock at the main donor site met the diameter criteria. Due to the shortage of large stock, cuttings that were slightly smaller than 2 cm in diameter were also collected and were referred to as "undersize stock."

The cuttings need to be soaked in fresh water for 7–10 days to remove rooting inhibitors before planting (D. Polster, pers. comm., 2004). One challenge of this project was finding adequate soaking sites, as nearby ponds were shallow and water levels dropped during the soaking period due to warm, dry weather. As a result, bundles had to be repositioned several times to avoid drying out. Beavers added another challenge: they raided the soaking area; removed some of the largest cuttings, stripping the bark and cambium layers from others; and sometimes took entire bundles.

Once most of the donor stock had been collected, the crew split up: one crew continued cutting, while the second crew began planting stakes. The planting crew collected the bundles from the soaking sites, taking the earliest cuttings first; and then transported them to the treatment sites where they were cut with lopping shears into 1 m length stakes in preparation for planting.

### Stake Planting

Due to the inherent difficulty of planting in gravel, an excavator with a digging bucket was used to install the cuttings in the coarse gravel bars. The use of the excavator minimized damage to the stock during planting, and ensured that the cuttings were planted deep enough to survive the dry summer. The excavator did not dig holes, but rather inserted the bucket into the gravel and pulled back the material, creating a 1 m wide gap into which the stakes were placed by

*Continued on page 12*



Ian Redden

Figure 3. Crew member instructing student on planting stakes.

an average density of 17 200 stems per hectare. Planting took an average of 4.5 days per hectare, with a crew of four people working with the excavator.

With the live staking of gravel bars completed, the success of the project will depend on a number of factors, including the growth and survival of the stakes, mortality or stunting due to elk browse, and the response of the treated areas to peak flows.

### Monitoring

Long-term monitoring will allow us to assess the success of the live gravel bar staking in achieving the project goals. This information can also be used to help direct future restoration activities. The following measures

hand (Figure 3). The excavator then withdrew its bucket allowing the gravel to settle back in place. The stakes were planted with about three-quarters of their length in the gravel at a 45° or greater downstream angle (Figure 4). Four large stakes and three to five undersized stakes, if available, were placed into each opening, taking about one minute for each opening. While the undersized stakes may not flourish as well as the large stakes, they significantly increased the overall number of stakes planted, which should improve the chances of the project in overcoming mortality due to elk browse.

The excavator worked by backing upstream while planting in successive rows spaced 1.5–2 m apart and staggered to prevent large open patches within the planted areas. The first pass of planting occurred nearest the river channel with the excavator positioned at the edge of the zone to be planted. This ensured that the edge of the row nearest the river was planted parallel to the flow. The excavator then reached as far as possible upland from the river. To



Ian Redden

Figure 4. Planted stakes.

maximize the area covered with the available stock, the stakes were planted with tighter spacing and at higher densities on the first pass nearest the mainstem channel where they would likely receive the greatest flows.

Live staking planting began on September 29, 2004, and was completed on October 12. In total, 1.86 ha was planted at three sites at

were taken to assist in gauging project success.

The perimeters of the treated areas as well as longitudinal and cross-sectional profiles were surveyed at each site using a total station survey instrument. Benchmarks were established at each site for future reference during surveys and monitoring. Fifty-one monitoring plots, including seven control plots,

were established at various locations within the project area. Each research plot had a 3-m radius (28.3 m<sup>2</sup>). A subset of 16 research plots was established to monitor changes in substrate composition. Within each of these 16 plots the substrate in three 0.5-m<sup>2</sup> squares was photographed and documented. Vegetation surveys at each of the 51 monitoring plots included recording the number, species, and size of stakes planted in each plot. Finally, three permanent photo points were established at each treatment site for future monitoring. In 2005, the areas treated in 2004 will be monitored and additional live staking of gravel bars in the Elk River will take place.

*While securing funding to study the success of restoration treatments is difficult, monitoring of the live gravel bar staking project is needed to continually improve the selection and successful application of restoration techniques in British Columbia.*

## Summary of Lessons Learned

- Often spring planting offers several benefits in soil bioengineering. Due to funding timelines, we planted in the fall.
- Use the most recent air photos available for preliminary site selection and reconnaissance.
- Have several stock donor sites selected before beginning cutting. A local Ministry of Forests office or forest company may offer some advice on donor sites.
- Use high-quality lopping shears and hand pruners. The loss in productivity due to the use of poor equipment will cost more than the initial expense of purchasing quality equipment.
- Use lopping shears rather than a chainsaw to cut stakes to length. The chainsaw tended to make rougher cuts and “shred” the bark near the cut end.
- Avoid soaking sites near known beaver populations. The loss of bundled donor stock due to beavers was much higher than we had expected. Using beaver protection such as a rodent fence around the soaking bundles would have prevented some loss.
- Ensure soaking sites have stable water levels. The sudden change from wet weather to several days of dry weather caused one soaking site to dry up, and the bundles required repositioning several times during the soaking period. Covering soaking bundles with Silva cool-tarps may be beneficial in hot, sunny weather.
- Flag bundles collected each day with a different colour flagging tape. This system allows for quick and easy identification of the bundles when collecting them from the soaking site. Use bundles in the order that they were cut.
- While securing funding to study the success of restoration treatments is difficult, monitoring of the live gravel bar staking project is needed to continually improve the selection and successful application of restoration techniques in British Columbia. ~

## Acknowledgements

Mike Miles, a fluvial geomorphologist, assisted the project team by selecting suitable sites for live staking. David Polster, who largely pioneered this soil bioengineering technique in British Columbia, trained the crew to cut stakes to length. A core team of Mowachaht–Muchalaht First Nation forestry workers, supported by volunteers from the Gold River Streamkeepers and Gold River Secondary School, completed this work. The BC Hydro Bridge Coastal Fish and Wildlife Restoration Program funded this project.

## For further information, contact:

**Iain Cuthbert, M.Sc., R.P.Bio.**

Streamline Environmental Consulting Ltd.

786 Quilchena Crescent  
Nanaimo, BC V9T 1P6

**Tel: (250) 758-7980**

**Fax: (250) 758-8505**

**E-mail: [icuthbert@shaw.ca](mailto:icuthbert@shaw.ca)**

## References

- M. Miles and Associates. 1999. *Preliminary assessment of the effects of the Crest Creek and Heber River diversions on channel morphology. Consultant's report prepared for BC Hydro and Power Authority, Burnaby, B.C.*
- M. Miles and Associates. 2004. *Selection of sites for live gravel bar staking: Lower Elk River in Strathcona Park. Consultant's report prepared for BC Hydro, Bridge Coastal Fish and Wildlife Restoration Program, Burnaby, B.C.*
- Polster, D. 1999. *Soil bioengineering for steep/unstable slopes and riparian restoration. Streamline Watershed Restoration Technical Bulletin Volume 4, Number 4, Winter 1999. Available from: <http://www.forrex.org/streamline/issue.asp?issue=14>*
- Switzer, G. 1999. *Observations of the success of the willow planting on the sand, gravel and cobble bars of the lower San Juan River. Streamline Watershed Restoration Technical Bulletin Volume 4, Number 4, Winter 1999. Available from: <http://www.forrex.org/streamline/issue.asp?issue=14>*

# A Qualitative Hydro-Geomorphologic Risk Analysis for British Columbia's Interior Watersheds: A Discussion Paper

Kim Green, M.Sc., P.Geo.

## Editor's Notes:

A preliminary version of this article was published in ASPECT, May 2004. Since then, the article has been revised, based on numerous technical reviews. This article is intended to stimulate discussion among forest hydrologists about the development of a qualitative hydro-geomorphic risk analysis for B.C. watersheds. As a discussion paper, the author acknowledges some limitations in the material presented below in attempting to develop the framework.

## Introduction

Under British Columbia's new *Forest and Range Practices Act*, forest management is moving towards risk management and professional reliance. In this new regime, forest managers must understand potential risks to aquatic values associated with existing or proposed development in a watershed.

To date, industry and government professionals have had minimal discussions about a standard approach to hydrological risk analysis. Inconsistencies in methods, terminology, and elements being considered in hydrological risk analyses are causing significant differences in the way professionals estimate risk (e.g., Carver 2001; B.C. Ministry of Forests 2001; Uunila 2004).

Recently, the Association of Professional Engineers and Geoscientists of B.C. (2003) and the

B.C. Ministry of Forests (Wise *et al.* [editors] 2004) have developed provincial standards for landslide risk analysis. These efforts have given professionals an understanding of the terms and methods of risk analysis needed for detailed terrain stability mapping. Similar efforts to standardize methods and terminology are needed if hydrologic risk analyses are to become a widely accepted and valued component of forest management in British Columbia.

The author developed this hydro-geomorphic risk analysis for use in Southern Interior B.C. watersheds and presents it to open discussion regarding a consistent methodology for risk analysis. Terminology used in this risk analysis is generally consistent with definitions in *Risk Management: Guideline for Decision-Makers* (CSA 1997) and *Landslide Risk Case Studies in Forest Development Planning and Operations* (Wise *et al.* [editors] 2004).

## Natural Variability and Channel Response

Low-order watersheds (<100 km<sup>2</sup>) in British Columbia's Southern Interior have been shaped by their geology,

glacial history, and climate over the past 10 000 years (Clague [compiler] 1989). The physical, chemical, and biological characteristics of low-order streams are closely linked to hillslope (hydro-geomorphic) processes and riparian function (Montgomery and Buffington 1998; Gomi *et al.* 2002).

Natural disturbance events such as wildfire, pest epidemics, and floods routinely affect watersheds and constitute an intricate part of the dynamic and evolving landscape of the Southern Interior (Bragg 2000; Benda *et al.* 2003; Gayton 2003). Changes to streamflow, sediment delivery rates, and riparian function (collectively referred to as *watershed processes*) following natural disturbance define the natural variability of a watershed over time (Gomi *et al.* 2002; Miller *et al.* 2003). While natural disturbance events typically have substantial, immediate

*Under British Columbia's new Forest and Range Practices Act, forest managers must understand potential risks to aquatic values associated with existing or proposed development in a watershed.*

impacts on channel structure and aquatic values such as water quality and aquatic habitat (Rinne 1996), the influx of nutrients, sediment, and woody debris in the decades following the event can play a vital role in maintaining the aquatic ecosystem of a watershed (Benda *et al.* 2003; Figure 1).

A channel's response to disturbance events (i.e., the variability of channel morphology in time and space) depends on the disturbance regime of a watershed, which is a function of its geographic location (i.e., within British Columbia's hydro-climatic and physiographic regions) and physical attributes including bedrock geology and glacial/paraglacial history (B.C. Ministry of Transportation and Highways 1996; Montgomery and Buffington 1998; Hallett and Walker 2000; Obedkoff 2002; Miller *et al.* 2003).



Kim Green

**Figure 1.** Woody debris recruitment and sediment influx following fire are key factors in maintaining aquatic ecosystems in many Southern Interior watersheds. Photos are from similar low-order streams in Caven Creek, southeastern British Columbia. Stream (A) burned during the 2003 Plumbob fire. Stream (B) experienced a similar fire about 70 years ago.

Streams draining steep mountain slopes in the interior wet belt of British Columbia have larger peak discharges per unit area and experience a higher frequency of channel-forming events (e.g., debris flows, snow avalanches) than watersheds in arid, lowland regions (Jakob and Jordan 2001; Obedkoff 2002). As a result, the morphology of channels in the interior wet belt typically have greater natural spatial and temporal variability than channels in arid and semi-arid regions where less frequent events such as wildfire and floods define the disturbance regime.

Forest development in a watershed can cause changes to watershed processes including increased hillslope runoff and stream discharge (Troendle *et al.* 2001; Wemple and Jones 2003; Schnorbus and Alila 2004); increased rate of sediment delivery to streams (Roberts and Church 1986; Gomi and Sidle 2003); and reduced riparian function through removal of streamside vegetation and direct impacts to channel bed and banks (Bragg 2000; Faustini and Jones 2003). The potential for significant (observable, long-term) change to aquatic values in a watershed due to changes in watershed processes associated with forest development will be greater in channels that have

less natural variability in channel morphology.<sup>1</sup>

Maintaining or improving aquatic values of watersheds while maximizing harvesting opportunities is a primary management objective of forest development in British Columbia. Understanding watershed processes and the natural variability in channel condition and aquatic values allows forest managers to apply management practices to reduce the risk of direct negative impacts to low-order streams. In turn, this reduces the risk for cumulative impacts in higher-order streams.

### Hydro-geomorphic Risk Analysis

A qualitative risk analysis offers (1) a framework for forest hydrologists and geomorphologists to document critical watershed processes (i.e., stream discharge, rate of sediment delivery, and riparian function) that are linked to aquatic values; and (2) recommendations for sustaining or improving aquatic values within a watershed. This reconnaissance-level analysis is intended to help forest managers identify areas where a more detailed level of assessment is required.

Simply stated, estimation of risk to aquatic values from forest

development considers two independent factors: the potential response of the channel to changes in watershed processes and the potential impact of forest development on watershed processes. It is expressed as the product of two components: *channel sensitivity* (C) and *hydrologic hazard* (H).

$$Risk = C \times H$$

Hydro-geomorphic risk is determined for the main stem and significant tributary channels upstream of a point of interest (POI), such as a water intake structure or a specific fish habitat (elements at risk) for each watershed process or, where appropriate, for each identified aquatic value at the point of interest (e.g., water quality at the intake, channel stability on the fan). A simple matrix such as shown in Table 1 can be used to determine risk in this qualitative analysis.

Channel sensitivity, a measure of the vulnerability (robustness or fragility) of the channel given changes to watershed processes, depends on the physical attributes of the channel. Channel sensitivity is equivalent to consequence in the conventional equation of Risk = Hazard × Consequence.<sup>2</sup> The ratings of “low”, “moderate” and “high” sensitivity express the potential size of change to

<sup>1</sup>In general, channel types associated with transport-limited, alluvial valley segments (e.g., step-pool or riffle-pool channels) or those in supply-limited colluvial valleys dominated by forced alluvial reaches (LWD step-pool or step-bed channels) will have a greater potential for change than channel types in colluvial or bedrock valley segments (Montgomery and Buffington 1998).

Continued on page 16

**Table 1. Hydro-geomorphic risk matrix (B.C. Ministry of Forests 2002)**

Hydro-geomorphic risk <sup>a</sup>		Likelihood of a hydrologic hazard		
		Low	Moderate	High
Channel sensitivity	Low	Very low	Low	Moderate
	Moderate	Low	Moderate	High
	High	Moderate	High	Very high

<sup>a</sup>A rating of "negligible" can also be added to the matrix if channel condition is independent of a watershed process, or forest development does not affect watershed process.

the channel structure and associated aquatic values (collectively referred to as channel condition) and are assessed for each of the watershed processes separately. What each sensitivity rating implies in terms of probable level of impact to the channel/aquatic values is specific to a watershed and should be defined in the report. Example definitions are in the footnotes to Table 2.

Channel sensitivity to increases in peak discharge considers the potential for increased bedload transport, which is estimated by considering mean grain size, grain size distribution, channel gradient, and hydraulic roughness (O'Connor and Harr 1994; Buffington and Montgomery 1999; Church 2002). For example, a stream that has a cobble-boulder cascade morphology will have a smaller change to channel condition due to a given increase in peak discharge than a low-gradient, gravel, riffle-pool channel.

Channel sensitivity to increases in sediment delivery considers the capacity of the channel to transport sediment as determined by channel gradient and sediment storage opportunities. Due to increases in sediment delivery in the headwater reaches, a low-gradient (<5%) meandering channel with intervening wetland segments will have a smaller change to channel condition over the length of the channel network than a moderate gradient (5–15%) channel with limited sediment storage opportunities (Lisle 2000).

Channel sensitivity to disturbances of riparian function considers the past,

present, and future dependence of channel condition on riparian vegetation (Montgomery 2003). A channel with deciduous riparian species such as alder and willow, which are indicative of frequent flooding and snow avalanches, will be less sensitive to disturbance of riparian function than a channel with mature coniferous riparian species supplying large woody debris that contributes to channel bed and bank stability. Where stream temperature is a concern, the dependence of a channel on riparian function considers channel orientation, hillslope gradient, and riparian species (Brown 1980).

Channel sensitivity is estimated for the main stem channel and larger tributary channels through a combination of field assessment, interpretation of current and historical air photos, and analysis of regional hydrometric and climate information. Montgomery and MacDonald (2002) describe in detail a similar approach to assessment of channel condition and sensitivity.

Key channel attributes that contribute to the estimation of channel sensitivity for the three watershed processes are summarized in Table 2.

A *hydrologic hazard* is a harmful sustained change to a watershed process. The hydrologic hazards considered in this analysis are increased peak discharge ( $H_p$ ), increased rate of sediment delivery ( $H_s$ ), and decreased riparian function ( $H_r$ ) associated with proposed and existing development. The variability of watershed processes resulting from

past natural disturbance in a watershed forms a baseline for the assessment of hydrologic hazard.<sup>3</sup> In this assessment the likelihood of a hydrological hazard is expressed qualitatively as "low," "moderate," and "high." These ratings indicate that the likelihood of a harmful or potentially harmful change to a watershed process occurring within the time span of the development is "negligible," "not likely but possible," and "probable," respectively.

When detailed information such as flood frequency, annual sediment budgets, and the frequency of disturbance to riparian function is available, the risk analysis can be adapted to be more quantitative. This is done by expressing and contrasting the likelihood of a hydrologic hazard in the undeveloped (baseline) condition and developed (disturbed) condition as the annual probability ( $P_a$ ) and the long-term probability ( $P_x$ ) for the lifespan of the proposed development.

For example, a stream that experiences a major channel-forming flood event once every 50 years (1:50) has an annual probability of 0.02 (2%). If the development in question has a lifespan of 20 years the long-term probability ( $P_{20}$ ) of a channel-forming flood event is

$$P_x = 1 - (1 - (P_a))^x$$

$$\text{so } P_{20} = 1 - (1 - (1/50))^{20} = 0.33 \text{ (33\%).}^4$$

If development is estimated as potentially increasing the annual probability of a major channel-forming flood from a 1:50 to 1:20 return period (e.g., Schnorbus and Alila 2004, scenario 2/3U, Table 3) the long-term probability ( $P_{20}$ ) of a major channel-forming flood is increased to 0.64 (64%). In this case the proposed development increases the probability of a channel-forming flood event from 33 to 64% ( $\Delta 31$  percentage points). Professionals

<sup>3</sup>In this case, channel sensitivity (consequence) equals vulnerability because the spatial and temporal probabilities of the elements being considered (channel structure and aquatic values) are both equal to 1 (e.g., Wise *et al.* [editors] 2004, p. 16).

<sup>4</sup>For example, the frequency of channel-forming floods, return period of fire or forest health epidemics, distribution and frequency of occurrence of mass wasting or erosion events.

<sup>5</sup>See Wise *et al.* (editors, 2004), pp. 13–14, and Table, A4.2.





**Table 2. Channel sensitivity**

Watershed process	Channel sensitivity <sup>a</sup>	Typical channel attributes that contribute to channel sensitivity <sup>b</sup>
Increased peak discharge	Low	<ul style="list-style-type: none"> <li>Experiences frequent large, rapid peak flows: banks and floodplain vegetated with alder and willow, bright, scoured channel bed and banks, historically active fan; typical of channels draining watersheds with steep alpine headwaters</li> <li>Coarse-textured bedload, not the result of a single anomalous flood event or an anthropogenic disturbance; numerous boulder cascade or bedrock reaches</li> <li>Well-vegetated, overhanging banks (e.g., mature coniferous species with well-developed root system) and abundant functioning large woody debris (LWD) and debris jams that provide channel and bank stability</li> <li>Often includes channels in supply-limited, colluvial, or bedrock valley segments</li> </ul>
	Moderate	<ul style="list-style-type: none"> <li>Experienced larger flood events in the past, indicated by numerous, multi-aged vegetated bank sloughs, levees, or old woody debris jams at obstructions with minimal long-term changes to channel stability</li> <li>Some inherent capacity to withstand higher flows, such as overflow channels or an entrenched channel with resilient banks or non-alluvial segments</li> <li>Banks and riparian area vegetated with species that have well-developed root systems that protect the banks and forest floor from erosion</li> <li>Often includes forced alluvial channels in colluvial or bedrock valley segments or transitional morphologies in alluvial valley segments</li> </ul>
	High	<ul style="list-style-type: none"> <li>Does not experience frequent flood events; bed is dark and mossy, banks are overhanging, vegetated to bankfull, and show no or little evidence of old scour or overbank deposits</li> <li>Contains fine-textured bedload that is susceptible to erosion</li> <li>Partially or entirely confined and lacks structures, such as overflow channels, low gradient marshy reaches, and abundant functioning LWD that help reduce flow velocity</li> <li>Generally includes fine-textured, transport-limited plane-bed to riffle-pool channels or forced alluvial channels</li> </ul>
Increased sediment delivery <sup>c</sup>	Low	<ul style="list-style-type: none"> <li>Abundant locations for sediment storage, such as frequent functioning LWD jams or frequent low gradient unconfined sections (e.g., alluvial valley segments with riffle-pool channels)</li> <li>Contains slow-flowing, meandering stream (e.g., flows through marsh or wetland segments) and lacks the power to transport bedload (i.e., decoupled systems where source areas are isolated from downstream channels)</li> <li>Headwaters are steep snow avalanche and (or) debris flow gullies that deliver large volumes of sediment annually</li> </ul>
	Moderate	<ul style="list-style-type: none"> <li>Colluvial valley segments with some storage capacity, such as some long (&gt;100–200 m), low gradient sections (&lt;15%) that allow bedload sediment to settle out</li> <li>Bordered by currently inactive, but relatively numerous natural landslide scars or debris flow gullies</li> </ul>
	High	<ul style="list-style-type: none"> <li>Laterally confined, forced alluvial and riffle-pool to cascade-pool systems that will become aggraded</li> <li>Channel has little or no storage capacity so that increases in sediment delivery are likely to cause lateral avulsion or channel aggradation</li> <li>Additional sediment input will be rapidly transported through system to P.O.I. due to steep headwater tributaries and ephemeral channels (&gt;10%) with minimal opportunity for storage of sediment</li> </ul>
Decreased riparian function	Low	<ul style="list-style-type: none"> <li>Not dependent on LWD to control rate of sediment transport, such as a steep colluvial or bedrock channels or snow avalanche chutes</li> <li>Low gradient, braided, or anastomosing channels, situated on a wide valley bottom vegetated with shrubs</li> </ul>
	Moderate	<ul style="list-style-type: none"> <li>Requires some LWD in a number of reaches to offer long-term storage, moderate bedload transport rate, or shade and cover for aquatic habitat (e.g., forced alluvial, LWD step-pool, or step-bed channels in colluvial valley segments)</li> <li>Has tendency to migrate laterally across valley bottom and is unentrenched so that migration could be accelerated if valley bottom is disturbed and banks destabilized (e.g., meandering step-pool to riffle-pool channel in alluvial valley segment)</li> <li>Some reaches are oriented such that the riparian canopy produces shade and moderates water temperatures</li> </ul>
	High	<ul style="list-style-type: none"> <li>Entirely dependent on LWD to control bedload transport rates and maintain bank integrity</li> <li>Appears to migrate over floodplain/valley bottom frequently and requires a wide effective riparian area for long-term stability (typically LWD forced alluvial step-pool to cascade pool channels in colluvial valley segments)</li> <li>Dependent on riparian canopy to maintain water temperature and habitat values</li> </ul>

Notes:

<sup>a</sup>“High,” “moderate,” or “low” channel sensitivity is a measure of the size of observable, sustained impacts to channel morphology/aquatic values in response to a change in a watershed process. “High” implies extensive observable sustained negative impacts. “Moderate” implies local extensive or widespread moderate negative impacts. “Low” implies local moderate to no observable negative impacts.

<sup>b</sup>The list of channel attributes here is incomplete and is only for illustration. The attributes must be considered and interpreted in a temporal, spatial, and cumulative context, not in isolation.

<sup>c</sup>The sensitivity of the channel to increases in bedload sediment and increases in suspended sediment should be considered separately. In small headwater streams, suspended sediment is typically transported through the system rapidly, resulting in short-term negative changes to water quality.

*Continued on page 18*

undertaking the analysis must use their judgment to define the hazard ratings in terms of change in probability (see Wise *et al.* [editors] 2004, Chapter 3, Table 2).

The likelihood of a hydrologic hazard is estimated by considering the extent and location of existing or proposed development in a watershed with respect to elevation, aspect, hillslope gradient, and hillslope-channel connectivity. The biophysical conditions of the watershed, including forest canopy and terrain characteristics are also considered.

The likelihood of occurrence of increased peak discharge ( $H_p$ ) associated with existing or proposed development depends on the amount and distribution of the development; the current and historical forest cover characteristics; and the extent that basin physiography, such as the amount of alpine area or the variation of elevations and aspects, allows for de-synchronization of snowmelt runoff and controls streamflow (Schnorbus and Alila 2004). A low level of development (<20%) that is distributed over a range of different elevations and aspects in a forested watershed has a low likelihood of increasing peak discharge. A moderate level of development (20–40%) in a watershed that has an alpine-dominated peak discharge will also have a low likelihood of increasing peak discharge (Schnorbus and Alila 2004).

The likelihood of occurrence of increased sediment delivery ( $H_s$ ) in a watershed associated with development considers the location of existing or proposed development

with respect to unstable or potentially unstable slopes, the connectivity of hillslopes and channels, and the mechanism and frequency of natural sediment delivery events. Proposed development on or above unstable or potentially unstable slopes adjacent to the channel in a watershed with few natural sediment sources could have a high likelihood of increasing sediment delivery if roads or trails are proposed (Jordan 2002).

*A qualitative approach to hydro-geomorphic risk analysis is an effective tool to identify the key processes affecting aquatic values within a watershed and develop practical recommendations to minimize risks to aquatic values from forest development.*

The likelihood of occurrence of harmful changes to riparian function ( $H_r$ ) considers the location of existing or proposed development with respect to the functioning riparian area and the degree of natural variability (both spatial and temporal) in riparian function through the watershed. A moderate amount of development in a riparian area where immature coniferous and deciduous species offer limited riparian function will have a lower likelihood of development-related impacts than a similar level of development in a riparian area with a climax stand of mature coniferous species providing channel bed and bank stability.

The likelihood of occurrence of a hydrological hazard is determined through field assessment (focusing on observations that give information on past disturbance history of the watershed); observations of historical and recent air photos; and information from terrain stability, soil erosion, forest cover, and development maps. Examples of watershed attributes and development factors that contribute to the qualitative assessment of hydrologic hazard are presented in Table 3.

## Summary

Under British Columbia's new *Forest and Range Practices Act*, forest management is moving towards risk analysis and professional reliance. In this new regime, forest managers must thoroughly understand potential risks to aquatic values associated with existing or proposed development. Results of a hydro-geomorphic risk analysis can guide new forest development, identify areas where more detailed assessments are required, or direct mitigative work. The results can also be used to identify aquatic values and locations in the watershed that are suitable for monitoring.

The hydrologic risk analysis suggested here is ideally suited for low-order watersheds (<50 km<sup>2</sup>) but can be adapted for use in smaller first-order watersheds (<100 ha) as well as larger landscape-level watersheds (≥500 km<sup>2</sup>). In a detailed analysis, watershed processes are adjusted to reflect hillslope processes and more detailed, site-specific information is required such as likelihood of landslides, terrain and soil information, the nature of surface and subsurface runoff, slope gradient and aspect, and forest canopy characteristics. The potential for cumulative hydro-geomorphic impacts can be estimated in larger watersheds by dividing the landscape into smaller, hydrologically meaningful sub-basins and determining risk at each fan or confluence along the main stem channel. Applying this risk analysis to watersheds larger than about 50 km<sup>2</sup> could result in meaningless risk ratings due to the increased variability in basin response at large scales (Bunte and MacDonald 1999; Miller *et al.* 2003).

Risks to aquatic values exist regardless of forest development. Therefore, such development should not automatically be excluded from areas of higher risk. In these cases forest managers can adapt management practices to reduce the potential



**Table 3. Hydrological hazard**

Watershed process	Likelihood <sup>a</sup>	Watershed attributes and development factors contributing to hazard rating <sup>b</sup>
Increased peak discharge	Low	<ul style="list-style-type: none"> <li>Watershed has significant alpine area and peak flows dominated by alpine snowmelt</li> <li>Watershed has wide elevation/aspect component and openings are appropriately distributed</li> <li>Minimal existing/proposed development</li> <li>Minimal road density and ditches are not concentrating runoff</li> </ul>
	Moderate	<ul style="list-style-type: none"> <li>Moderate existing/proposed development in moderate to steep gradient, non-alpine watershed</li> <li>Moderate road density and ditches are concentrating and delivering runoff to stream network</li> <li>Development is limited in distribution and (or) focused on 1 or 2 elevation/aspect zones that could influence peak flows</li> </ul>
	High	<ul style="list-style-type: none"> <li>Watershed is forested to the headwaters and has an upper broad basin or plateau where development is concentrated</li> <li>Limited elevation/aspect distribution and development are concentrated in one or two areas that likely control peak flows</li> <li>Extensive existing/proposed development</li> <li>High road density and ditches are carrying intercepted and concentrated runoff to stream network.</li> </ul>
Increased sediment delivery	Low	<ul style="list-style-type: none"> <li>Low connectivity (coupling) between hillsides and valley bottom</li> <li>Large watershed with the capacity to dilute local forestry related sedimentation events</li> <li>Stable and non-erodible terrain is adjacent to channel</li> <li>Low road density and few stream crossings</li> </ul>
	Moderate	<ul style="list-style-type: none"> <li>Some coupling between valley sides and stream channel with moderate density of roads/trails on or above unstable or potentially unstable slopes adjacent to channel</li> <li>Moderate road density and number of stream crossing on steep slopes with erodible soils</li> </ul>
	High	<ul style="list-style-type: none"> <li>Channels are directly coupled to valley sides with high road/trail density located on or above unstable terrain</li> <li>Watershed is small with no opportunity for sediment dilution</li> <li>High road density with numerous stream crossings on moderate to steep slopes with erodible soils</li> </ul>
Decreased riparian function	Low	<ul style="list-style-type: none"> <li>No development in riparian zone</li> <li>Appropriately sized riparian buffers in place</li> <li>Few stream crossings by roads or trails</li> </ul>
	Moderate	<ul style="list-style-type: none"> <li>Significant amount of riparian area directly impacted by development</li> <li>Undersized riparian buffers along some of the channel resulting in a reduction of LWD recruitment or shade function of canopy</li> <li>High density of stream crossings by roads or trails</li> </ul>
	High	<ul style="list-style-type: none"> <li>Large amount of development/disturbance in riparian area</li> <li>Undersized or no riparian buffers along more than half of channel</li> <li>Main stem channel oriented east-west with moderate or low gradient hillsides. Development/disturbance has removed significant amount of riparian vegetation on south side of channel.</li> </ul>

**Notes:**

<sup>a</sup> The ratings of “low,” “moderate,” and “high” indicate that the likelihood of a harmful or potentially harmful change to a watershed process occurring within the time span of the development is negligible, not likely but possible, and probable, respectively.

<sup>b</sup> The typical watershed attributes and development factors given for the “low,” “moderate,” and “high” hazard ratings are for discussion purposes only. Different watersheds will respond differently to similar levels of road development and harvesting.

hazards associated with development. Strategies to reduce the likelihood of occurrence of a hazard and thereby reduce development-related risk could include undertaking detailed drainage plans to maintain natural drainage patterns, conducting riparian assessments to ensure block boundaries do not impinge on riparian function, or adjusting the size or distribution of cutblocks to reduce the potential for increasing peak flows.

As with any analysis of qualitative risk, this analysis is subject to professional experience and judgment. Therefore,

all observations, interpretations, and assumptions should be appropriately documented.

Eventually, with continued research initiatives directed at quantifying the effects of timber harvest and road development on watershed processes (e.g., Schnorbus and Alila 2004), the strength of risk analyses like the one presented here will improve. Until then, a qualitative approach to hydro-geomorphologic risk analysis is an effective tool to identify the key processes affecting aquatic values within a watershed and develop practical recommendations to

minimize risks to aquatic values from forest development. 

**Acknowledgements**

The author is indebted to Doug Vandine, P.Eng., P.Geo.; Rita Winkler, RPF, Ph.D.; Peter Jordan, P.Geo., Ph.D.; Will Halleran, P.Geo.; and Brett Eaton, Ph.D. Several anonymous reviewers offered valuable discussions and comments to this manuscript. Thanks also to Younes Alila, Ph.D., P.Eng., for insightful discussions regarding channel-forming flows and natural variability in watershed processes.

*Continued on page 20*

**For further information, contact:**

**Kim Green M.Sc., P.Geo.**

Apex Geoscience Consultants Ltd.

1220 Government Street

Nelson, BC V1L 3K8

**E-mail: [apexgeo.kg@telus.net](mailto:apexgeo.kg@telus.net)**

**References**

- Association of Professional Engineers and Geoscientists of B.C. (APEGBC). 2003. Overview of B.C. M.o.F. landslide hazard and risk case studies document. Participant handouts for APEGBC Annual Conference, Penticton, B.C., October 23–25, 2003.
- B.C. Ministry of Forests. 2001. Watershed assessment procedure guidebook. Second edition. Version 2.1. Forest Practices Branch, Victoria, B.C. Forest Practices Code Guidebook.
- B.C. Ministry of Forests. 2002. Forest road engineering guidebook. Forest Practices Branch, Victoria, B.C. Forest Practices Code of Guidebook.
- B.C. Ministry of Transportation and Highways. 1996. Natural hazards in British Columbia. Prepared by B.C. Ministry of Transportation and Highways, Geotechnical and Materials Engineering Branch in association with VanDine Geological Engineering Ltd.
- Benda, L., D. Miller, P. Bigelow, and K. Andras. 2003. Effects of post-wildfire erosion on channel environments, Boise River, Idaho. *Forest Ecology and Management* 178(1–2):105–119.
- Bragg, D.C. 2000. Simulating catastrophic and individualistic large woody debris recruitment for a small riparian system. *Ecology* 81(5):1383–1394.
- Brown, G.W. 1980. Forestry and water quality. Oregon State University, Corvallis, Oreg. 121 p.
- Buffington, J.M. and D.R. Montgomery. 1999. Effects of hydraulic roughness on surface textures of gravel-bed rivers. *Water Resources Research* 35(11):3507–3521.
- Bunte, K. and L.H. MacDonald. 1999. Scale considerations and the delectability of sedimentary cumulative watershed effects. U.S. National Council for Air and Stream Improvement, January 1999. Technical Bulletin No. 766.
- Canadian Standards Association (CSA). 1997. Risk management: guidelines for decision-makers, a national standard of Canada. CSA International, CAN/CSA-850-97, Etobicoke, Ont.
- Carver, M. 2001. Using indicators to assess hydrologic risk. In *Watershed assessment in the Southern Interior of British Columbia*. D.D.A. Toews and S. Chatwin (editors). B.C. Ministry of Forests, Research Branch, Victoria, B.C. Working Paper 57/2001.
- Church, M. 2002. Geomorphic thresholds in riverine landscapes. *Freshwater Biology* 47:541–557.
- Clague, J.J. (compiler). 1989. Quaternary geology of the Canadian Cordillera. Chapter 1 in *Quaternary Geology of Canada and Greenland*. R.J. Fulton (editor). Geological Survey of Canada, Ottawa, Ont. *Geology of Canada*, No. 1.
- Faustini, J.M. and J.A. Jones. 2003. Influence of large woody debris on channel morphology and dynamics in steep, boulder-rich mountain streams, western Cascades, Oregon. *Geomorphology* 51:187–205.
- Gayton, D.V. 2003. British Columbia grasslands: monitoring vegetation change. FORREX-Forest Research Extension Partnership, Kamloops, B.C. FORREX Series 7.
- Gomi, T. and R.C. Sidle. 2003. Bed load transport in managed steep-gradient headwater streams of southeastern Alaska. *Water Resources Research* 39(12):1336. doi: 10.1029/2003WR002440.
- Gomi, T., R.C. Sidle, and J.S. Richardson. 2002. Understanding processes and downstream linkages of headwater systems. *Bioscience* 52(10):905–916.
- Hallett, D. and R. Walker. 2000. Paleocology and its application to fire and vegetation management in Kootenay National Park, British Columbia. *Journal of Paleolimnology* 24(4):401–414.
- Jakob, M. and P. Jordan. 2001. Design flood estimates in mountain streams: the need for a geomorphic approach. *Canadian Journal of Civil Engineering* 28:425–439.
- Jordan, P. 2002. Landslide frequencies and terrain attributes in Arrow and Kootenay Lakes Forest Districts. In *Terrain stability and forest management in the interior of B.C.* P. Jordan and J. Orban (editors). B.C. Ministry of Forests Technical Report 003.
- Lisle, T.E. 2000. The fate of large sediment inputs in rivers: implications for watershed and waterway management. *AEG News* 43(4):99.
- Miller, D., C. Luce, and L. Benda. 2003. Time, space and the episodicity of physical disturbance in streams. *Forest Ecology and Management* 178:121–140.
- Montgomery, D.R. 2003. Wood in rivers: interactions with channel morphology and processes. *Geomorphology* 51:1–5.
- Montgomery, D.R. and J.M. Buffington. 1998. Channel processes, classification, and response. In *River ecology and management*. R. Naiman and R. Bilby (editors). Springer-Verlag, New York, N.Y., pp. 13–42.
- Montgomery, D.R. and L.H. MacDonald. 2002. Diagnostic approach to stream channel assessment and monitoring. *Journal of the American Water Resources Association* 38(1):1–16.
- Obedkoff, W. 2002. Streamflow in the Kootenay Region. B.C. Ministry of Sustainable Resource Management, Water Information Section, Aquatic Information Branch, Victoria, B.C.
- O'Connor, M. and R.D. Harr. 1994. Bedload transport and large organic debris in steep mountain streams in forested watersheds on the Olympic Peninsula, Washington. Final report. Timber/Fish/Wildlife Sediment, Hydrology and Mass Wasting Steering Committee, and State of Washington Department of Natural Resources. 122 p.
- Rinne, J.H. 1996. Short-term effects of wildfire on fishes and aquatic macroinvertebrates in the southwestern United States. *Journal of Fisheries Management* 16:653–658.
- Roberts, R.G. and M. Church. 1986. The sediment budget in severely disturbed watersheds, Queen Charlotte Range, British Columbia. *Canadian Journal of Forest Research* 16:1092–1106.
- Schnorbus, M.A. and Y. Alila. 2004. Forest harvesting impacts on the peak flow regime in the Columbia Mountains of southeastern British Columbia: an investigation using long-term numerical modeling. *Water Resources Research* 40(5):W05205. doi:10.1029/2003WR002918.
- Troendle, C.A., M.S. Wilcox, G.S. Bevenger, and L.S. Porth. 2001. The Coon Creek Water Yield Augmentation Project: implementation of timber harvesting technology to increase streamflow. *Forest Ecology and Management* 143:179–187.
- Uunila, L. 2004. Final report, Crawford Creek watershed hydrologic assessment, Phases 1 and 2. Prepared for B.C. Ministry of Forests, B.C. Timber Sales, Nelson, B.C. Summit Environmental Consultants Ltd. (Volumes 1 and 2) 114 p. + appendices and maps.
- Wemple, B.C. and J.A. Jones. 2003. Runoff production on forest roads in a steep mountain catchment. *Water Resources Research* 39(8):1220. doi: 10.1029/2002WR001744.
- Wise, M.P., G.D. Moore, and D.F. VanDine (editors). 2004. *Landslide risk case studies in forest development planning and operations*. B.C. Ministry of Forests, Research Branch, Victoria, B.C. Land Management Handbook No. 56. Available from: [www.for.gov.bc.ca/hfd/pubs/Docs/Lmh56.htm](http://www.for.gov.bc.ca/hfd/pubs/Docs/Lmh56.htm)

# Re-creating Meandering Streams in the Central Oregon Coast Range, USA

Barbara Ellis-Sugai and Johan Hogervorst

## Introduction

For many years, the riparian and stream functions of Bailey and Karnowsky creeks on the Central Oregon Coast Range have been impaired. The valleys were homesteaded in the 1800s; by the early to mid-1900s, both streams were channelized into ditches to increase the amount of land available for pasture. This channelization decreased sinuosity, resulting in increased stream gradients and water velocities. Both stream channels subsequently incised into the easily erodible valley floor. In Bailey Creek, the stream channel started to meander in the ditch, which increased bank erosion and sediment deposition into Mercer Lake. In Karnowsky Creek, larger tributary streams with gradients under 5% were also channelized and downcut to depths of greater than 3 m. These conditions led to a loss of aquatic habitat, disconnected floodplains, lower groundwater tables, and increased bank erosion and sedimentation.

Since 1999, the Siuslaw National Forest and partners have restored the stream channels and valley floor of Bailey and Karnowsky creeks. Lessons learned in Bailey Creek were applied to Karnowsky Creek.

For both streams, we had to answer the questions: What type of stream should we build that will fit the valley type? What should the dimensions of the new channel be, including width, depth, cross-sectional area, gradient, sinuosity, and depth and length of

pools? Our project goals included (1) improving coho salmon rearing habitat; (2) reconnecting channels to floodplains; (3) restoring riparian vegetation; and (4) reducing sedimentation. We intended to create channels that are “stable”: in other words, they are able to transport the sediment load associated with local deposition and scour while maintaining a consistent channel size and shape (Rosgen 1996). At the same time, we expected lateral migration, via bank erosion and point bar deposition, over time.

This article describes the methods and lessons learned in re-creating two stream channels on the Central Oregon Coast Range.

## Bailey Creek Restoration Project

In 1991, the U.S. Forest Service acquired Enchanted Valley in a large land exchange with a timber company; thus, the land changed from private to public ownership. Bailey Creek flows through Enchanted Valley into Mercer Lake, near Florence, Oregon. In 1995, we began the project by gathering data on existing stream conditions. We compared Bailey Creek with a similar coastal stream that had not been cleared and channelized. A topographic map at a 0.3 m (1 ft.) contour interval of the Bailey Creek

valley floor was created. Other data collected included several cross-sections of the existing ditch, pebble counts at the cross-section locations, a longitudinal profile of the ditch, and cross-sections and pebble counts upstream from the channelized section. For reference on pre-channelized conditions, we used historical aerial photos (1955) that showed the position, sinuosity, and meander geometry of the original stream channel in the valley above the project area before channelization. Determining the bankfull, or “design,” flow was the most

*Determining the bankfull, or “design,” flow was the most challenging aspect of data collection.*

challenging aspect of data collection. We determined this parameter via three different sources of information: (1) 16 years of correlated flow measurements to rainfall records (from Giese 1996); (2) measured discharge in the field during winter flow events; and (3)

comparison of Bailey Creek to other nearby gauged watersheds.

In our restoration plan, we wanted the new stream to flood frequently during the winter to re-establish seasonal wetland characteristics, and to minimize the risk that the new channel would readjust through bank erosion. We considered designing either a wide, shallow stream (a “C” channel type, width/depth [W/D] ratio > 12, using Rosgen’s [1996] terminology), or a narrow, deep channel (an “E” channel type, W/D ratio < 12; Rosgen [1996]). Based on the valley’s low gradient, the geomorphic setting (an old lake bed), and reference stream

Table 1. Enchanted Valley specifications

Basin area	11.4 km <sup>2</sup> (4.4 mi. <sup>2</sup> )
Valley slope	0.34%
Valley length	954 m (3100 ft.)
Streambank substrate	60% silt/clay, 40% sand

Continued on page 22



Figure 1. Low-elevation aerial photograph of the new Bailey Creek channel before connection to the old ditch, September 2000.

This method allowed us to easily adjust the proposed location of the stream. We subsequently designed a pool-riffle morphology for the stream bottom, with the pools occupying the outside bends of meanders. The final “string” map was then digitized and put into a geographical information system. Stake co-ordinates were calculated and surveyed onto the ground.

The new 1692 m (5500 ft.) long channel was excavated in late summer 1999 (Figure 1). The outside bends of meanders were revegetated with willow stakes in early spring 2000, and the new channel was connected to the ditch in October 2000. The abandoned ditch

downstream of the connection was then intermittently plugged with fill material that was originally stockpiled during channel construction, forming ponds in the unfilled areas. The ponds were located where small tributaries drained off the side slopes, and connected to the new channel. Since then, wood has been added to the channel, and native hardwoods, conifers, and shrubs have

been planted in the riparian zone along the new channel.

### Karnowsky Creek Channel Restoration Project

Karnowsky Creek, which was acquired by the U.S. Forest Service in 1992, flows into the Siuslaw River estuary between Florence and Mapleton, Oregon. In partnership with the Siuslaw Watershed Council and the Siuslaw Soil and Water Conservation District, we hired a student intern team to develop a whole-watershed restoration plan during the summer of 2001. This team researched watershed history, fish and wildlife habitat, and plant communities, and subsequently drafted a restoration proposal. We used this proposal to apply for funds from the Oregon Watershed Enhancement Board and the National Forest Foundation.

The restoration plan for Karnowsky Creek was similar to Bailey Creek, emphasizing the creation of summer and winter rearing habitat for coho. One heavily aggraded section of ditch that had suitable existing spawning habitat was left to passively recover. In contrast with the Bailey Creek channel design, we relied less on discharge calculations and measurements, and more on bankfull cross-sections in the existing ditch to determine the cross-sectional area of the new channel. We assumed that the ditch

cross-sections, we chose an “E” channel. To ensure flooding during the winter flows, we designed the new channel’s cross-sectional area to be 30% smaller than the existing ditch (Tables 1 and 2).

The design parameters were then translated onto our base map, using a piece of string cut to the length of the new channel at the scale of our map.

Table 2. Bailey Creek measurements

Parameter	Historic channel	Ditch	New channel
Sinuosity	1.7	1.1	1.8
Gradient	0.22%	0.32%	0.19%
Bankfull width	8.5–12 m (28.5–40 ft.) (based on cross-sections above channelized section)	4–4.5 m (13–15 ft.)	6 m (20 ft.)
Bankfull depth	No information	1.5–2 m (5–7 ft.)	0.9 m (3 ft.) in riffles 1.5 m (5 ft.) in pools
Belt width	68–85 m (220–275 ft.)	Not applicable	46–77 m (150–250 ft.)
Meander length	77 m (250 ft.) (average)	Not applicable	73 m (239 ft.) (average)
Radius of curvature	25 m (82 ft.) (average) 12–43 m (40–140 ft.) (range)	Not applicable	16 m (52 ft.) (average)
Width/depth (W/D) ratio	No information	2–3 in lower valley; 25 above channelized section	7
Cross-section area	No information	8.36 m <sup>2</sup> (90 ft. <sup>2</sup> )	6.27 m <sup>2</sup> (60 ft. <sup>2</sup> )
Total channel length	No information	1105 m (3627 ft.)	1692 m (5500 ft.)

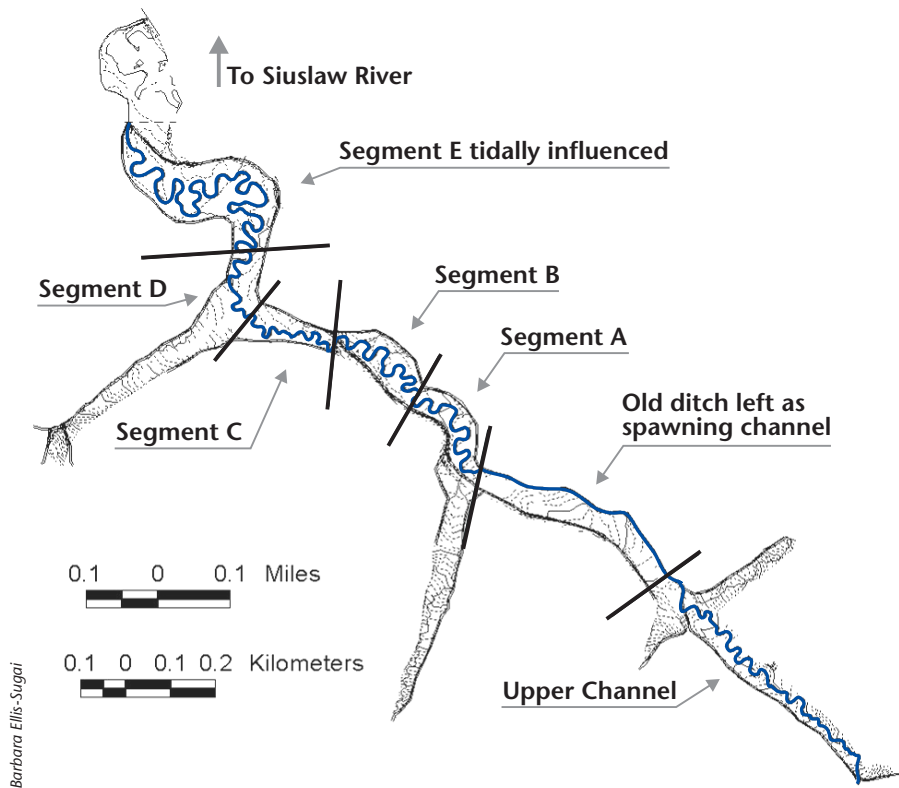

Figure 2. Map of the Karnowsky Creek valley floor and new channel. Key: black, bold solid lines-old ditches; dark blue, bold lines-new channel.

had come into equilibrium with bankfull flows, and would more accurately reflect the new channel's size requirement than flow equations. To cross-check, we calculated the bankfull discharge for the existing ditch and compared it with the new channel using a regional equation for small watersheds developed at Oregon State University (Adams *et al.* 1986), the regional U.S. Geological Survey equations (Jennings *et al.* 1993), and Manning's equation. As with Bailey Creek, we wanted the channel to frequently overtop its banks. Therefore, the new channel's cross-sectional area was designed to be 33% smaller than the existing ditch.

In our restoration plan, we explicitly defined the desired width/depth (W/D) ratio, the slope, and the sinuosity of the new channel. The W/D ratio is important because it is a major control on shear stresses within the channel. To determine whether

the stream should be a "C" or "E" channel (Rosgen 1996), we used the W/D ratio from a nearby reference stream (9.5), and referred to Rosgen's (1996) classification system. Unlike the Bailey Creek design, we allowed more variation in the size and shape of the meanders (Williams 1986). We ran several W/D combinations through Manning's equation and shear stress equations to compare the

existing ditch's estimated discharge and shear stress with that calculated for the new channel. We chose a W/D ratio of 9.3, a relatively narrow channel. The rationale was that the vegetation on the valley floor will support the higher shear stresses found in an "E" channel, and a narrower, deeper channel would have less direct solar heating. The new channel's dimensions are shown in Table 3.

For Karnowsky Creek, the upper valley is slightly steeper, while the lower, tidally influenced valley has a very low gradient. To fit the valley, we designed the new stream's gradient to gradually decrease from 0.76% at the top to 0.11% in the tidally influenced zone. Likewise, sinuosity increases down valley, from 1.2 to 2.8. In the tidally influenced zone, where frequent winter flooding occurs, we wanted to create diverse fish habitat

As with Bailey Creek, once the slope and sinuosity were established, the new channel was laid out on the base map, and surveyed onto the ground (Figure 2). The survey data for the channel location and existing ground elevations were entered into a spreadsheet. The expected bank heights in the new channel, assuming a constant stream gradient through a reach, were then calculated. The upstream and downstream locations for pools and riffles were added.

*Continued on page 24*

Table 3. New Karnowsky Creek channel dimensions							
Channel segment	Width	Riffle depth	W/D ratio	Cross-section area	Gradient (%)	Sinuosity	New channel length
Upper channel	3.1 m (10 ft.)	0.3 m (1 ft.)	10	0.93 m <sup>2</sup> (10 ft. <sup>2</sup> )	0.76	1.2	684 m (2223 ft.)
A	4.3 m (14 ft.)	0.46 m (1.5 ft.)	9.3	2.0 m <sup>2</sup> (21 ft. <sup>2</sup> )	0.39	1.9	393 m (1278 ft.)
B	4.3 m (14 ft.)	0.46 m (1.5 ft.)	9.3	2.0 m <sup>2</sup> (21 ft. <sup>2</sup> )	0.28	2.2	546 m (1773 ft.)
C	4.3 m (14 ft.)	0.46 m (1.5 ft.)	9.3	2.0 m <sup>2</sup> (21 ft. <sup>2</sup> )	0.38	1.6	356 m (1157 ft.)
D	4.3 m (14 ft.)	0.77 m (2.5 ft.)	5.6	3.3 m <sup>2</sup> (35 ft. <sup>2</sup> )	0.20	1.6	226 m (733 ft.)
E	4.3 m (14 ft.)	0.77 m (2.5 ft.)	5.6	3.3 m <sup>2</sup> (35 ft. <sup>2</sup> )	0.11	2.8	1356 m (4406 ft.)

Continued from page 23

J.B. Hogenvorst



**Figure 3.** Construction of the new Karnowsky Creek channel, summer 2002. Stakes in foreground identify the location of a transition from a riffle to a pool. Note the excavated mounds of soil left on the floodplain.

The new Karnowsky stream channel was built in late summer 2002 (Figure 3). In the lower part of the valley, where wet soil conditions persist throughout the year, the excavated material was piled in mounds and shaped on the valley floor. This method reduced both haul costs and potential for soil compaction from dump truck traffic. Mounds also offered high points in the floodplain that provided good planting sites for Sitka spruce and western redcedar. During the first winter after construction, willow stakes were planted in the banks, and trees and shrubs in the floodplain. At that time, water was not flowing in the main channel, which gave the willows a chance to establish.

During the second summer (2003), ditches were plugged in several

strategic locations, and water was diverted into the new channel. We applied the lessons learned in Bailey Creek, where we had left an abrupt vertical wall at the connection between the old ditch and new channel. The old ditch was 1 m (3 ft.) below the new channel. We erroneously assumed that sediment would drop out at this point, as water slowed to enter the new channel at a lower gradient, and cause aggradation in the old ditch. However, a tail cut began to develop downstream from this point as the channel's longitudinal profile came into equilibrium between the two elevations. In Karnowsky Creek, the new channel was designed to gradually slope up from the old ditch's bed elevation to the new channel, about a 0.3 m (1 ft.) difference in elevation. A ramp of large logs was buried at grade in the new channel at the connection to prevent downcutting.

In the fall of 2003, 130 large, whole trees were added to the new channel and floodplain by helicopter to provide current and future cover for fish-rearing areas. Based on research by Roelof (2002), who completed the planting plan for the project, we tried to approach 10% coverage of the valley floor with this wood in 3–4 ha less than 2% of the valley floor. Work in three steeper side tributaries and the upper main stem is ongoing, and may supply additional spawning

habitat to complement rearing habitat created by the work discussed in this paper. In 2004, the new upper channel was connected to the existing channel, and the ditch in the upper valley was filled in.

## Monitoring

Both streams are being monitored with permanent cross-sections, low-elevation aerial photographs, on-the-ground photo points, spawning surveys, juvenile fish counts, and collection of water-quality data. In Karnowsky Creek, a network of groundwater wells is being measured monthly to track groundwater levels.

## Results of Restoration

### Bailey Creek

The new channel increased channel length by 33% and doubled the pool volume compared with the old ditch. The stream overflows its banks during winter, and the channel appears to be relatively stable, although adjustments are occurring. In some places, point bars and mid-channel bars are being deposited, as expected (Figures 4a and 4b). Since the new Bailey Creek was connected to the existing channel in 2000, U.S. Geological Survey river gauges on the Alsea River to the north, and the Siuslaw River to the south have shown annual peak flows to be slightly below average. The gauge record goes back to 1940 on the Alsea River. No gauges are on nearby streams of comparable size.

J.B. Hogenvorst



**Figure 4a.** New Bailey Creek channel at photo point 7, summer 1999.



**Figure 4b.** New Bailey Creek channel at photo point 7, summer 2003.

Jeff Schmalenberg



Fish numbers, both returning spawning adults and rearing juvenile coho, have increased. Spawning surveys over the last 4 years indicate a definite increase in numbers, averaging over 322 fish per kilometre (200 fish per mile) compared with an average of 113 fish per kilometre (70 fish per mile) annually during the 4-year period before the new channel was built (1996–1999). The increase from 2002 to 2003 alone was 130 fish per kilometre (81 fish per mile). The 2003 spawning adults were the first juveniles reared in the project area to have returned. The assumption is that juveniles of this year's class took advantage of both favourable conditions in the new channel and the ocean to produce the 2003 spawning numbers. Bailey Creek was



Barbara Ellis-Sugai

*Figure 5. The new Karnowsky Creek channel in the lower valley during high winter flows. Conifer seedlings in plastic tubes are planted on the mounds left on the floodplain.*

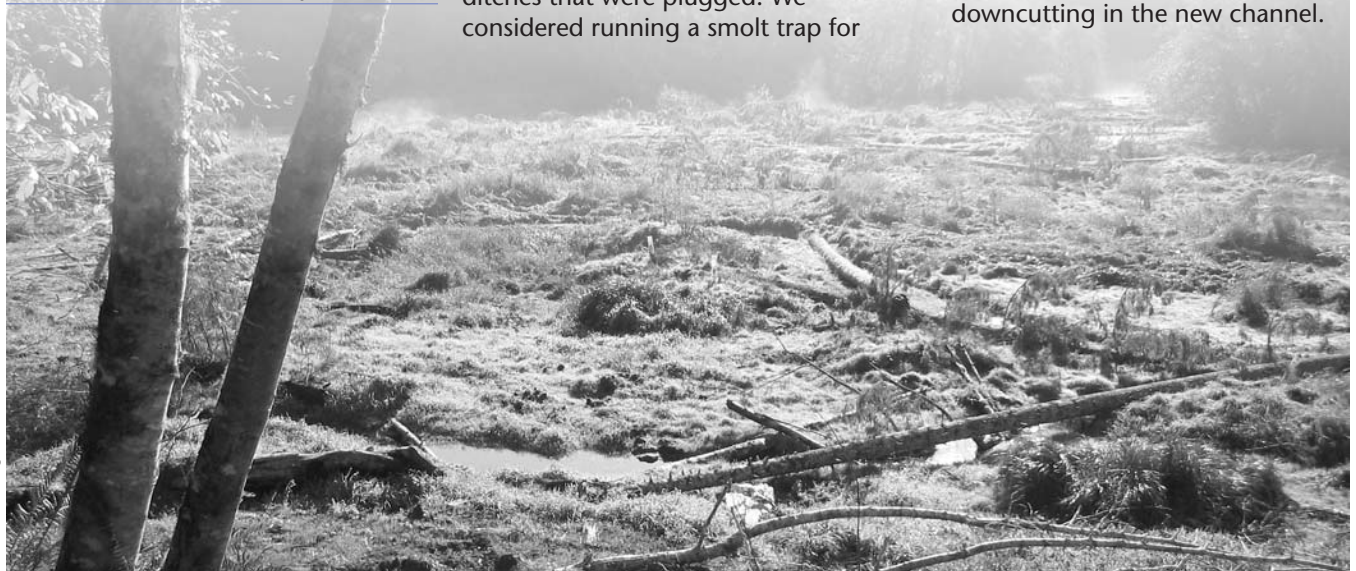

Barbara Ellis-Sugai

*Figure 6. The new Karnowsky Creek channel with large wood added, winter 2003. New conifer seedlings are planted along the bank and protected by plastic tubing.*

one of the few areas where spawning counts increased in 2003. The control data indicate that from 2001 to 2003, the number of juvenile coho was 1.5–2.0 times higher compared with the two previous years' samples. At the same time, there was roughly a 10-fold increase in numbers of juvenile coho in the project area in 2001–2003. For 2003, the control estimate was 0.5 coho per square metre while the project area estimate was 1.1 coho per square metre.

### **Karnowsky Creek**

Although it is too early to have significant monitoring results, we are already seeing abundant coho smolts and fry in the new Karnowsky Creek channel. The channel functioned well through the first two winters, with frequent floodplain inundation. Willows and other riparian vegetation are growing well, and point bars are being deposited on the inside of meander bends in the lower channel. Little, if any, bank erosion is evident (Figures 5 and 6). The mounds built into the floodplain of the lower valley are successful nurseries for young conifers and shrubs.

Future monitoring of fish populations will include summer snorkel counts in pools of the new channel and spot checks of ponds created from the old ditches that were plugged. We considered running a smolt trap for

the spring migration, but frequent floodplain inundation, along with lack of funding, labour resources, and research groups prohibits this level of monitoring.

Spawning surveys are also ongoing, particularly in a 0.8-km (0.5-mi.) section of upper main stem that was reconstructed and connected to water in 2004. In December 2004, coho salmon were observed spawning at the top of the upper main-stem channel, just 2 months after that section of the new channel was connected to the existing stream channel.

### **Summary of Lessons Learned**

- Cross-sections of the existing ditch are probably more reliable than regional flow equations or discharge measurements when determining the size of the new channel.
- Creating hummocks in the floodplain aids in re-establishing vegetation in areas infested with reed canary grass, and provides micro-topographic sites. It also saves hauling of the excavated material.
- Grade control and a smooth transition from the existing ditch to the new channel will prevent downcutting in the new channel.

*Continued on page 26*

- These restoration projects require intensive data-gathering and planning by an interdisciplinary team of hydrologists, geomorphologists, fisheries biologists, botanists, and surveyors, and benefit from review by other technical experts. ~

**For further information, contact:**

**Barbara Ellis-Sugai**  
 Forest Hydrologist  
 Siuslaw National Forest  
 4077 Research Way  
 Corvallis, OR 97333  
 Tel: (541) 750-7056  
 E-mail: bellisugai@fs.fed.us

**Johan Hogervorst**  
 South Zone Hydrologist  
 Siuslaw National Forest  
 4480 Hwy 101, Bldg G  
 Florence, OR 97439  
 Tel: (541) 902-6956  
 E-mail: jhogervorst@fs.fed.us

**References**

Adams, P.W., A.J. Campbell, R.C. Sidle, R.L. Beschta, and H.A. Froelich. 1986. *Estimating stream flows on small forested watersheds for culvert and bridge design in Oregon*. Oregon State University, Forest Research Laboratory, College of Forestry, Corvallis, Oregon. *Research Bulletin* 55. 8 p.

Giese, T.P. 1996. *Phosphorus export from the Clear and Mercer Lake watersheds*, Oregon State University, Corvallis, Oregon. M.S. thesis, 136 p.

Jennings, M.E., W.O. Thomas Jr., and H.C. Riggs. 1993. *U.S. Geological Survey Water-Resources Investigations Report 94-4002: nationwide summary of U.S. Geological Survey regional regression equations for estimating magnitude and frequency of floods for ungaged sites*. 196 p.

Roelof, S. 2002. *Of fire and fog: representing landscape processes and catalyzing nonlinear transformation in a Coast Range riparian zone*. M.S. thesis draft. University of Oregon, Department of Landscape Architecture, Eugene, Oregon.

Rosgen, D. 1996. *Applied river morphology*. Wildland Hydrology [consultant], Pagosa Springs, Colorado. 363 p.

Williams, G.P. 1986. *River meanders and channel size*. *Journal of Hydrology* 88:147-164.

# Results of Streamline Reader Survey 2004

**Robin Pike**

**T**HANK YOU to everyone who participated in our reader survey this past fall. The survey was designed to help us assess our performance and, most importantly, solicit your feedback on areas for improvement and suggestions for future articles. Overall, respondents told us that we are on track in presenting objective and reliable watershed management information. Here are the highlights of the survey.

## Streamline articles are technically reviewed and those readers polled trust information presented in Streamline.

Of those polled, 42% were unaware that all articles published in Streamline undergo a technical peer review. As a result, we will better communicate the measures we use to ensure that reliable and sound information is extended. Despite this finding, 92% of those surveyed indicated that they either have a lot of trust (25%) or a fair amount of trust (67%) in Streamline. Only 5% of the respondents indicated that they had little trust in Streamline as an information source.

## Streamline is relevant, scientifically sound, user friendly, and easy to access. Most readers prefer the current format.

Of those completing the survey, 90% indicated that they prefer the current mix of short newsletter-style and longer technical articles. Preference for print versus online versions of the publication was more evenly split among respondents, with 51% favouring online access, 41% print, and 8% both publication formats. We will seriously consider these data if limited funding in the future does not allow us to produce print versions.

Regarding our publication format, most respondents agreed or strongly agreed that articles in Streamline are relevant and applicable (92%), scientifically sound (82%), readable in style (94%), well laid out (84%), easy

**Jack Minard of the Tsolum River Restoration Society, Courtenay, B.C., won our survey draw-prize—a \$75 gift certificate to Chapters.**

Question: In your opinion, are Streamline articles...	Strongly agree (%)	Agree (%)	Neutral (%)	Somewhat disagree (%)	Strongly disagree (%)
1. Relevant and applicable	26	66	7	1	0
2. Scientifically sound	19	63	17	1	0
3. Readable in style	27	67	4	2	0
4. Well laid out	31	53	15	0	1
5. Easy to access	36	56	7	1	0
6. Innovative in content	14	52	30	4	0



**Table 2. Reader suggestions for future content**

Proposed article topic / content direction	Rank <sup>a</sup>
More of the same mix	1
Watershed/stream restoration	2
Monitoring/assessment	3
More forestry	4
Fish habitat/fisheries	4
Methods and techniques	5
Riparian issues and science	5
Water conservation/social issues	5
Stewardship	6
Water chemistry, quality, and health	6
Hydrology/Watershed processes	6
Non-forested watersheds/urban watershed management	6
Biology/Biodiversity	6
Broaden scope to include international case studies	6
Standards/BMPs/Policy	6
Groundwater	7
Less forestry	8
Wildfire effects	8
Opinion pieces	8
Current updates from around B.C.	8

<sup>a</sup>Reader suggestions were grouped into the above categories. The number of suggestions per category was tallied and rank was assigned (1 to 9). Tied rank values represent categories with an equal tally.

to access (92%), and innovative in content (66%). As a result we are not planning to change the format. Complete results, including percentage of neutral responses and those in disagreement, are presented in Table 1.

**Streamline articles elevate readers' knowledge of watershed management science and issues. Those readers polled indicated that they are happy with the current mix of topics and recommended that Streamline continue to feature diverse topics.**

Respondents were asked to comment on how Streamline has improved or

assisted them in their work activities or decisions. Most commonly, respondents stated they use Streamline to increase their awareness and (or) background knowledge of watershed management issues and science. A few readers said they use Streamline articles for teaching and training.

Readers were also asked if they could identify a favourite article over the last 2 years. Many suggestions were put forward, the most common being "Shade and Stream Temperature" by P. Teti, followed by "Wildfires and Watershed Effects in the Southern B.C. Interior" by D. Scott and R. Pike.

Readers also offered feedback on the types of articles they want to see in

future issues. We grouped the 105 suggestions into categories (Table 2). Notably, most of these suggestions support the current direction of Streamline's expanded watershed management mandate. The most common response was for a continuation in the diversity of topics covered.

**Streamline is providing timely access to information, thus increasing knowledge of watershed management research, hydrologic processes and the effects of watershed management.**

Finally, we asked readers if we were achieving our objectives (Table 3). While these results are qualitative and have their limitations, 74% agreed that we're giving them timely access to information, 93% indicated that Streamline increases their knowledge of current B.C watershed management research and expertise, and 76% indicated that Streamline increases their knowledge of natural hydrologic processes and the effects of watershed management. Overall, the survey results will greatly assist us in managing Streamline, leveraging financial support, and ultimately offering a reader-focused and relevant publication. 

If you would like to provide further feedback on Streamline or suggest an idea for an article, please contact Robin Pike at

(250) 387-5887, or by e-mail at [Robin.Pike@forrex.org](mailto:Robin.Pike@forrex.org).

**Table 3. Client satisfaction in Streamline's performance against objectives**

Question: Does Streamline...	Strongly agree (%)	Agree (%)	Neutral (%)	Somewhat disagree (%)	Strongly disagree (%)
1) Provide timely access to watershed management information?	21	53	25	1	0
2) Increase your knowledge of current B.C. watershed management research and expertise?	38	55	6	1	0
3) Increase your knowledge of natural hydrologic processes and the effects of watershed management?	19	57	23	1	0

# UPDATE

## Upcoming Events

### **April 16–20, 2005**

33rd Annual BCWWA Conference and Trade Show.  
Penticton, BC  
<http://www.bcwwa.org/newsdocs/mailler/BCWWA-AGM-Exhibition-Brochure-v1.4.pdf>

### **April 26–27, 2005**

Implications of Climate Change in BC's Interior Forests.  
Revelstoke, BC  
<http://www.cmiae.org/>

### **May 4–7, 2005**

49th Annual BCWF Convention: Navigating the Turbulent Waters of Conservation in British Columbia.  
Nanaimo, BC  
<http://www.bcwf.bc.ca/s=142/bcw1089397688895/>

### **May 8–11, 2005**

Canadian Geophysical Union Annual Scientific Meeting.  
Banff, AB  
<http://www.ucalgary.ca/%7Eecuconf/>

### **May 25–27, 2005**

North American Association of Fisheries Economists (NAAFE) 3rd Biennial Forum.  
Vancouver, BC  
<http://www.feru.org/events/naafe.htm>

### **May 31–June 4, 2005**

2005 Joint International Conference on Landslide Risk Management and 18th Annual Vancouver Geotechnical Society Symposium.  
Vancouver, BC  
<http://cgs.ca/2005ICLRM/>

### **June 14–17, 2005**

58th Annual CWRA National Conference, Reflections on our Future...a New Century of Water Stewardship.  
Banff, AB  
<http://www.reflectionsonourfuture.ca/>

### **August 8–11, 2005**

Earth System Processes II. Geological Society of America.  
Calgary, AB.  
<http://www.geosociety.org/meetings/esp2/>

### **August 16–19, 2005**

Second North American Lake Trout Symposium.  
Yellowknife, NWT  
<http://www.laketroutsymposium2005.ca/>

### **August 17–19, 2005**

Hydrotechnical Engineering: Cornerstone of a Sustainable Environment.  
Edmonton, AB  
[www.hydrotechnics.ca/hydro2005](http://www.hydrotechnics.ca/hydro2005)

### **September 13–15, 2005**

10th International Specialist Conference on Watershed and River Basin Management 2005.  
Calgary, AB  
<http://content.calgary.ca/CCA/City+Hall/Business+Units/Waterworks/Events/1WA+Watershed+Conference+2005.htm>

### **September 29 to October 1, 2005**

The Coastal Cutthroat Symposium: Biology, Status, Management, and Conservation.  
Fort Worden State Park (near Port Townsend, Washington)  
<http://www.orafs.org/cutthroat.html>

## Recent Publications

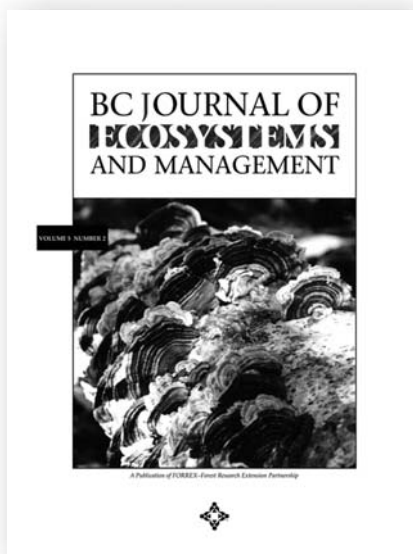

**BC Journal of Ecosystems and Management Volume 5, Number 2**  
Densmore, N., J. Parminter, and V. Stevens. 2004. Coarse woody debris: Inventory, decay modelling, and management implications in three biogeoclimatic zones. BC Journal of

Ecosystems and Management 5(2). Available from:  
<http://www.forrex.org/jem/2004/vol5/no2/art3.pdf>

Gayton, D. 2004. Nature conservation in an era of indifference. BC Journal of Ecosystems and Management 5(2). Available from:  
<http://www.forrex.org/jem/2004/vol5/no2/art1.pdf>

Krzic, M., H. Page, R.F. Newman, and K. Broersma. 2004. Aspen regeneration, forage production, and soil compaction on harvested and grazed boreal aspen stands. BC Journal of Ecosystems and Management 5(2). Available from:  
<http://www.forrex.org/jem/2004/vol5/no2/art4.pdf>

Lewis, J.L., S.R.J. Sheppard, and K. Sutherland. 2004. Computer-based visualization of forest management: A primer for resource managers, communities, and educators. BC Journal of Ecosystems and Management 5(2). Available from:

<http://www.forrex.org/jem/2004/vol5/no2/art2.pdf>

Morford, S., D. Robinson, F. Mazzone, C. Corbett, and H. Schaiberger. 2005. Participatory research in rural communities in transition: A case study of the Malaspina–Ucluelet Research Alliance. BC Journal of Ecosystems and Management 5(2). Available from:  
[www.forrex.org/jem/2004/vol5/no2/art5.pdf](http://www.forrex.org/jem/2004/vol5/no2/art5.pdf)

Prescott, C., L. Blevins, and C. Staley. 2005. Litter decomposition in British Columbia forests: Controlling factors and influences of forestry activities. BC Journal of Ecosystems and Management 5(2). Available from:  
<http://www.forrex.org/jem/2004/vol5/no2/art6.pdf>

### **New text book**

Northcote, T.G. and G.F. Hartman (editors). 2004. Fishes and Forestry: worldwide watershed interactions and management. Blackwell Science, London, U.K. 789 p.